



DS5F series servo driver
User manual

WUXI XINJE ELECTRIC CO., LTD.

Data No. SC5 02 20200217 2.3

Basic explanation

- Thank you for purchasing Xinje DS5F series servo driver products.
- This manual mainly introduces the product information of DS5F series servo driver and MS series servo motor.
- Before using the product, please read this manual carefully and connect the wires on the premise of fully understanding the contents of the manual.
- Please deliver this manual to the end user.

This manual is suitable for the following users

- Designer of servo system
- Installation and wiring workers
- Commissioning and servo debugging workers
- Maintenance and inspection workers

Get the manual

- Please consult the supplier, agent and office who purchased the product.

Declaration of liability

- Although the contents of the manual have been carefully checked, errors are inevitable, and we cannot guarantee complete consistency.
- We will often check the contents of the manual and make corrections in the subsequent versions. We welcome your valuable comments.
- If there is any change to the contents introduced in the manual, please understand without further notice.

Contact information

- Tel: 400-885-0136
- Fax: 0510-85111290
- Address: Floor 4, building 7, creative industry park, No. 100, DiCui Road, Wuxi City
- Postcode: 214072

WUXI XINJE ELECTRIC CO., LTD. Copyright

Without explicit written permission, this material and its contents shall not be copied, transmitted or used, and the violator shall be liable for the losses caused. All rights provided in the patent license and registration including utility module or design are reserved.

Jan. 2019

Safety Precautions

Be sure to review this section carefully before use this product. In precondition of security, wire the product correctly.

Before using this product, please read this part carefully and operate after fully understanding the use, safety and precautions of the product. Please connect the product correctly on the premise of paying great attention to safety.

The problems that may arise during the use of the product are basically listed in the safety precautions, and all are indicated by the two levels of attention and danger. For other unmentioned matters, please follow the basic electrical operation rules.



Caution

When used incorrectly, there may be danger, moderate injury or minor injury, and property loss.



Danger

When used incorrectly, it may cause danger, personal casualties or serious injuries, as well as serious property losses.



Attention to Product Confirmation

1. Do not install damaged drives, drives that lack spare parts, or drives whose models do not meet the requirements.



Installation Notes

1. Before installing wiring, be sure to disconnect the power supply to prevent electric shock.
2. It is forbidden to expose the product to water, corrosive gases, flammable gases and other substances, causing electric shock and fire hazards.
3. Do not touch the conductive part of the product directly, which may cause misoperation and malfunction.



Cautions for wiring

1. Please connect AC power to LN or L1/L2/L3 or R/S/T on the dedicated power terminal of the driver. Do not connect the output terminals U, V, W of the driver to the three-phase power supply.
2. Please connect the ground wire correctly. Poor grounding may cause electric shock. Please use 2mm² wire to ground the ground terminal of the driver.
3. Please lock the fixed screw of the terminal, otherwise it may cause fire.
4. Be sure to disconnect all external power supply before wiring the driver.
5. Wiring, please ensure that the encode line, power line is loose, do not tighten, lest cable damage.



Operation Cautions

1. Do not touch the rotating part of the motor after the driver is running. There is a danger of injury.
2. Please pay attention to the test run of the motor once, do not connect the motor with the machine, there is the possibility of injury.
3. After connecting the machine, please set the appropriate parameters before running, otherwise it may cause the machine out of control or failure.
4. In operation, do not touch the radiator, there is a risk of scald.
5. Under power-on condition, do not change the wiring, there is a risk of injury.
6. Do not switch power frequently. If you need to switch power many times, please control it once in 2 minutes.



Maintenance and inspection

1. Do not touch the inside of servo driver and servo motor, otherwise it may cause electric shock.
2. When the power is started, it is forbidden to remove the driver panel, otherwise it may cause electric shock.
3. Within 10 minutes of power off, the terminal should not be contacted. Otherwise, the residual voltage may cause electric shock.



Wiring attention

1. Do not cross the power line and the control signal line from the same pipeline, nor tie them together. The power line and the control signal line are separated by more than 30 centimeters.
2. For signal line and encoder (PG) feedback line, please use multi-stranded wire and multi-core stranded integral shielding line. For wiring length, the longest signal input line is 3 meters and the longest PG feedback line is 20 meters.

▶▶ Confirmation on product arrival.....	8
1 Selection of servo system.....	9
1.1 Selection of servo driver.....	9
1.1.1 Model name.....	9
1.1.2 Description of each part	9
1.1.3 Performance specification.....	9
1.2 Servo motor selection.....	10
1.2.1 Model name.....	10
1.2.2 Description of each part	11
1.3 Cable selection	11
1.3.1 Model name.....	11
1.3.2 Description of each part	12
1.4 Selection of other accessories.....	15
1.4.1 Selection of regenerative resistance	15
2 Installation of servo system.....	16
2.1 Servo driver installation	16
2.1.1 Installation site	16
2.1.2 Environment condition.....	16
2.1.3 Installation standard	16
2.2 Servo motor installation	18
2.2.1 Environment condition.....	18
2.2.2 Installation cautions	19
2.2.3 Installation environment.....	20
2.3 Servo cable installation	21
2.3.1 Cable selection	21
2.3.2 Xinje cable specification.....	22
2.4 Servo driver dimension	24
2.5 Servo motor dimension	26
3 Wiring of servo system	30
3.1 Main circuit wiring.....	31
3.1.1 Servo driver terminal arrangement.....	31
3.1.2 Main circuit terminals	31
3.1.3 CN0, CN1, CN2 terminal.....	32
3.1.4 Communication port.....	35
3.2 Classification and function of signal terminals.....	36
3.2.1 Pulse signal	36
3.2.2 SI input signal	37
3.2.3 SO output signal.....	37
3.2.4 Analog input circuit.....	38
3.2.5 Encoder feedback output signal	39
4 Operate panel	40
4.1 Basic operation.....	40
4.1.1 Operating panel description	40
4.1.2 Button operation.....	40
4.2 Operation display	41
4.3 Group U monitor parameter	43
4.4 Group F auxiliary function parameters.....	46
4.4.1 Group F0	46
4.4.2 Group F1	46
4.5 Fault alarm handling.....	48
4.6 Parameter setting example.....	48
4.7 Change motor code.....	49
5 Operation of servo system.....	50
5.1 Control mode selection and switching.....	50
5.1.1 Control mode selection	50
5.1.2 Control mode switching	51
5.2 Basic function setting	52
5.2.1 Jog operation.....	52
5.2.2 Servo enable setting	53

5.2.3	Rotation direction switching	54
5.2.4	Stop mode	54
5.2.5	Power-off brake.....	57
5.2.6	Braking setting	59
5.3	Position control	61
5.3.1	General position control.....	61
5.3.2	Position control (external pulse command).....	70
5.3.3	Position control (Internal command).....	72
5.4	Speed control.....	80
5.4.1	Speed mode general control	80
5.4.2	Speed control (internal speed).....	82
5.4.3	Speed control (pulse frequency command)	85
5.4.4	Speed control (external analog value).....	86
5.5	Torque control	89
5.5.1	Torque general mode.....	89
5.5.2	Torque control (internal setting)	89
5.5.3	Torque control (external analog value)	90
5.6	Absolute value system.....	93
5.6.1	Absolute system setting.....	93
5.6.2	Replace the battery	93
5.6.3	The upper limit of turns.....	94
5.6.4	Read absolute position through communication	95
5.6.5	Reset absolute position.....	96
5.7	Auxiliary functions.....	97
5.7.1	Anti-blocking protection	97
5.7.2	Torque limit.....	98
5.7.3	Speed limit	99
5.7.4	I/O signal distribution	99
5.7.5	Output terminal function.....	100
5.7.6	Input terminal function.....	105
5.7.7	Time limit curve of overload protection.....	106
5.8	Encoder ABZ phase frequency division output	108
5.9	Full closed-loop input.....	110
5.9.1	Full closed-loop input specification	110
5.9.2	Full closed-loop mode operation steps.....	111
5.9.3	Full closed-loop control parameter	112
6	Servo gain adjustment.....	115
6.1	Overview of servo gain adjustment	115
6.1.1	Overview and process	115
6.1.2	The difference of these adjustment modes	116
6.1.3	Model loop control.....	116
6.1.4	Torque disturbance observation	118
6.2	Rotary inertia presumption	119
6.2.1	Overview	119
6.2.2	Notes	119
6.2.3	Operation tool	119
6.2.4	Operation steps.....	120
6.3	Fast adjustment.....	123
6.3.1	Overview	123
6.3.2	Fast adjustment steps.....	124
6.3.3	Rigidity level corresponding gain parameters.....	124
6.3.4	Notes	127
6.4	Auto-tuning	127
6.4.1	Overview	127
6.4.2	Notes	127
6.4.3	Operation tools.....	128
6.4.4	Internal instruction auto-tuning steps.....	128
6.4.5	External instruction auto-tuning steps.....	132
6.4.6	Related parameters	136
6.5	Manual adjustment	137
6.5.1	Overview	137
6.5.2	Adjustment steps	138

6.5.3 Gain parameters for adjustment	138
6.6 Adaptive	140
6.6.1 Overview	140
6.6.2 Notes	140
6.6.3 Operation steps.....	140
6.6.4 Inertia mode and related parameters	140
6.6.5 Recommended inertia ratio parameters	141
6.6.6 Adaptive parameters effect.....	141
6.6.7 Invalid parameters when adaptive effective	142
6.7 Vibration suppression.....	142
6.7.1 Overview	142
6.7.2 Operation tools	143
6.7.3 Vibration Suppression (Panel)	143
6.7.3 Vibration suppression (panel)	143
6.7.4 Vibration suppression (PC software)	144
6.7.5 Vibration suppression (manual setting).....	145
6.7.6 Vibration suppression (quick FFT)	145
6.7.7 Notch filter	146
6.8 Gain adjustment.....	148
6.8.1 Load shaking	148
6.8.2 Vibration	148
6.8.3 Noise	148
7 Alarm	149
7.1 Alarm code list	149
7.2 Analysis of alarm types	151
8 Modbus-RTU communication	161
8.1 Communication wiring.....	161
8.2 Communication parameters.....	163
8.3 Communication protocol.....	165
8.3.1 Character structure	165
8.3.2 Communication data structure	165
8.4 Communication example.....	166
8.4.1 Communication with Xinje PLC.....	166
9 Appendix.....	168
Appendix 1. Group P parameters	168
P0-XX:	168
P1-XX:	171
P2-XX:	172
P3-XX:	174
P4-XX:	176
P5-XX:	177
P6-XX:	181
P7-XX:	182
P9-XX:	184
Appendix 2. UX-XX monitoring parameters	184
U0-XX:	184
U1-XX:	186
U2-XX:	186
U3-XX:	187
U4-XX:	187
Appendix 3. FX-XX auxiliary function parameters	187
Appendix 4. Modbus address list	188
Appendix 5. Q&A	192
Appendix 6. General debugging steps	195
Appendix 7. Application example	196
Appendix 8. Servo general mode parameters	197
Appendix 8.1 Basic parameters.....	197
Appendix 8.2 External pulse position mode general parameters	197
Appendix 8.3 Internal position mode general parameters.....	198
Appendix 8.4 Internal torque control general parameters	198
Appendix 8.5 External analog torque control general parameters	198
Appendix 8.6 Internal speed control general parameters	199
Appendix 8.7 External pulse speed control general parameters.....	199

Appendix 8.8 External analog speed control general parameters	199
Appendix 9. Torque-speed characteristic curve.....	200
Appendix 10. List of model selection and configuration.....	203

►► Confirmation on product arrival

After the product arrives, please confirm the integrity of the product in the following aspects.

Items	Notes
Does the product on arrival match the specified model?	Please confirm according to the nameplate of servo motor and servo unit.
Does the servomotor shaft rotate smoothly?	The servo motor shaft is normal if it can be turned smoothly by hand. Servo motors with brakes, however, cannot be turned manually.
Is there any damage?	Check the overall appearance, and check for damage or scratches that may have occurred during shipping.
Are there any loose screws?	Check screws for looseness using a screwdriver.
Is the motor code the same with the code in drive?	Check the motor code marked on the nameplates of the servomotor and the parameter U3-00 on the servo drive.

If any of the above is faulty or incorrect, contact Xinje or an authorized distributor.

1 Selection of servo system

1.1 Selection of servo driver

1.1.1 Model name

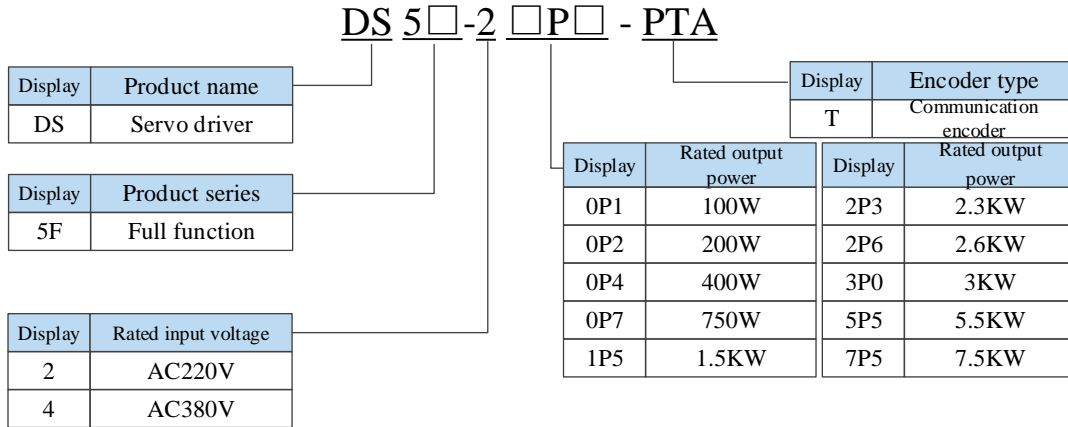

1.1.2 Description of each part

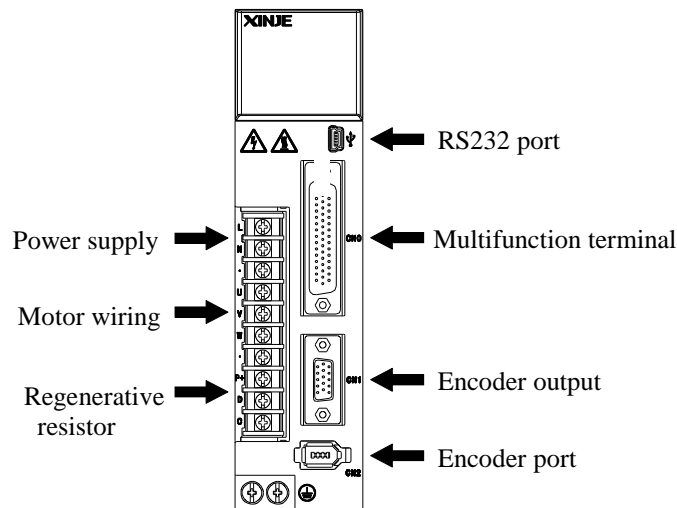

1.1.3 Performance specification

Servo unit	DS5F series servo drive
Applicable encoder	Standard: 17-bit/23-bit communication encoder
Input power supply	DS5□-2□P□-PTA: Single/three phases AC200-240V, 50/60Hz [single phase AC200-240V 50/60Hz is used for less than 1.5KW (excluding 1.5KW); Three phase AC200-240V 50/60Hz is recommended for 1.5KW and above. (if single-phase power supply, please connect it to R and T, otherwise, the parameter memory will be affected in case of power failure)
	DS5□-4□P□-PTA: three-phase AC340~420V, 50/60Hz
Control mode	Three-phase full-wave rectifier IPM PWM control sinusoidal current drive mode
Using condition	Using temperature
	-10~+40 °C

	Storage temperature	-20~+60 °C
	Environment humidity	Below 90%RH (no condensation)
	Vibration resistance	4.9m/s ²
Structure	Pedestal installation	

1.2 Servo motor selection

1.2.1 Model name

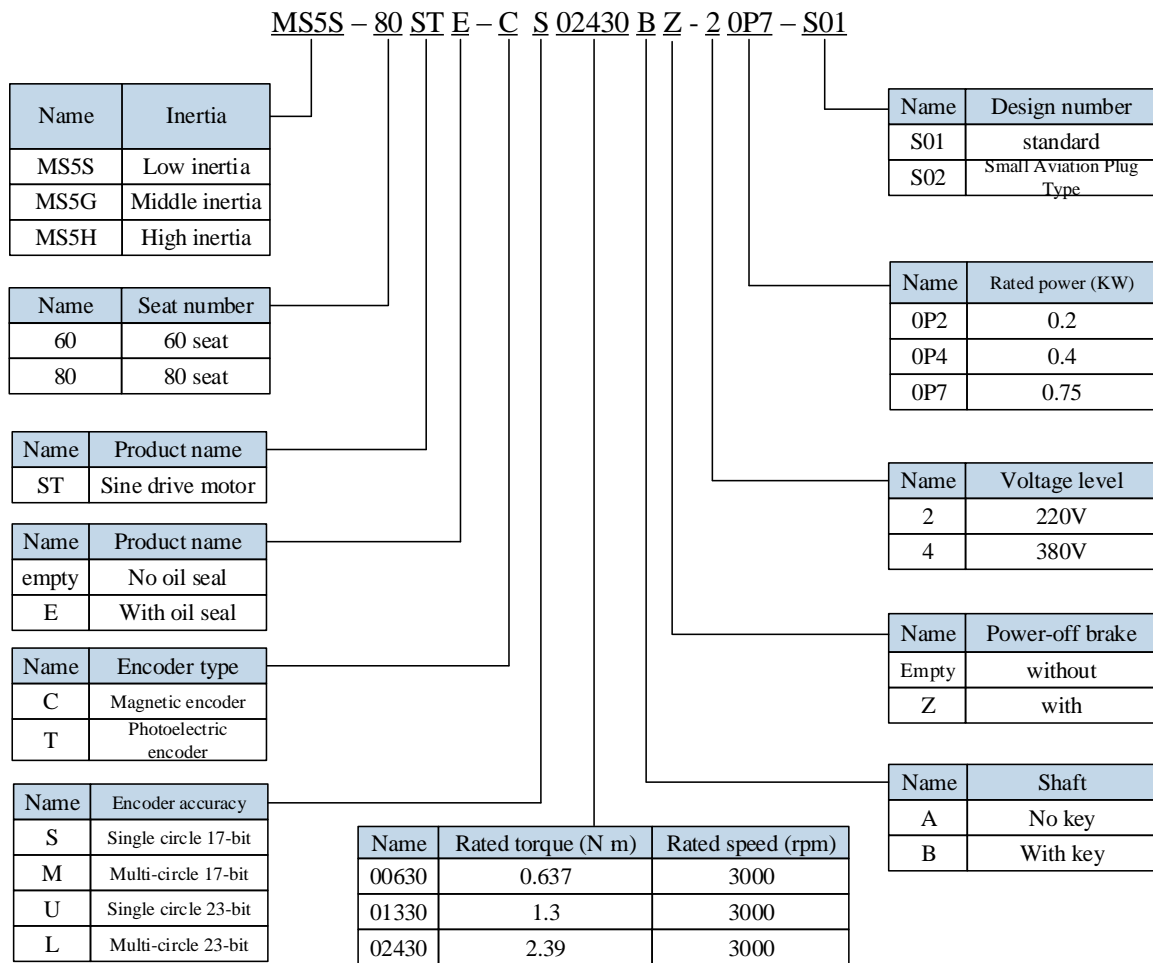

Note: At present, only the combination of CS, CM, TL and T is selected for the type of encoder.

1.2.2 Description of each part

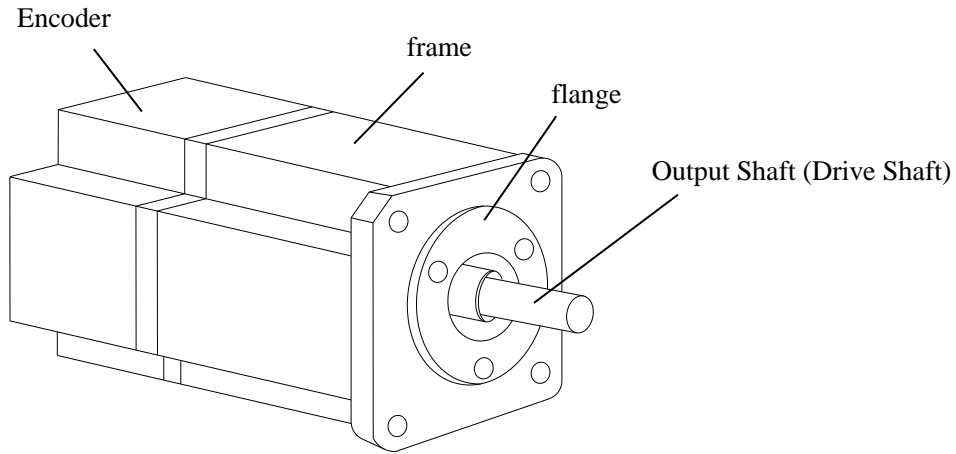

1.3 Cable selection

1.3.1 Model name

- Encoder cable model

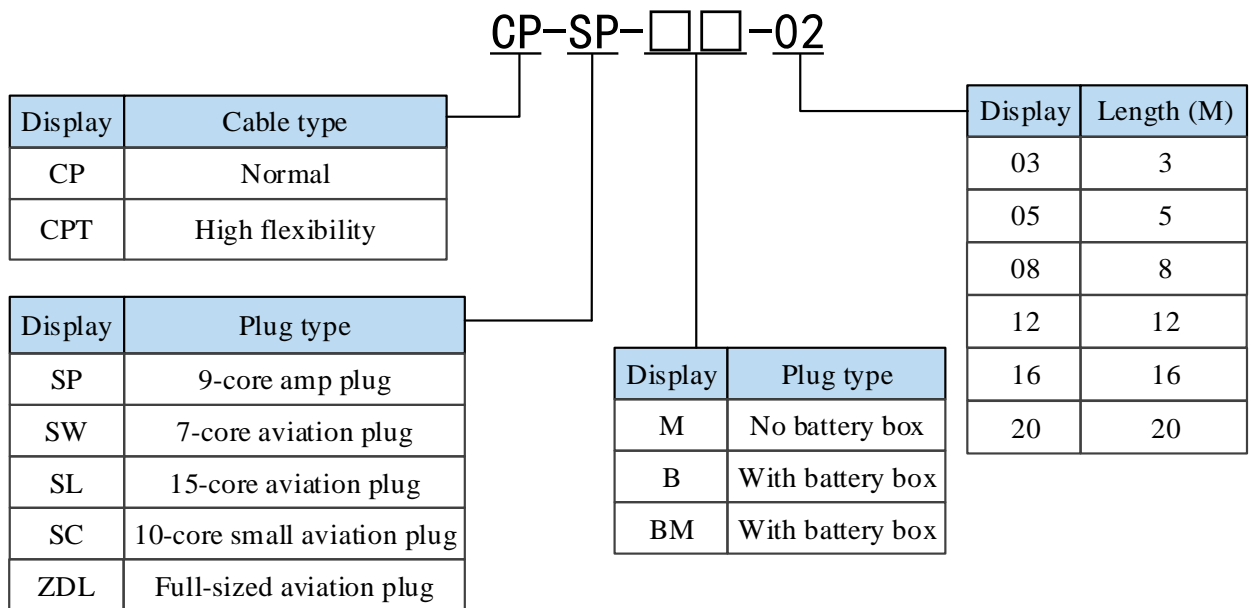

■ Power cable model

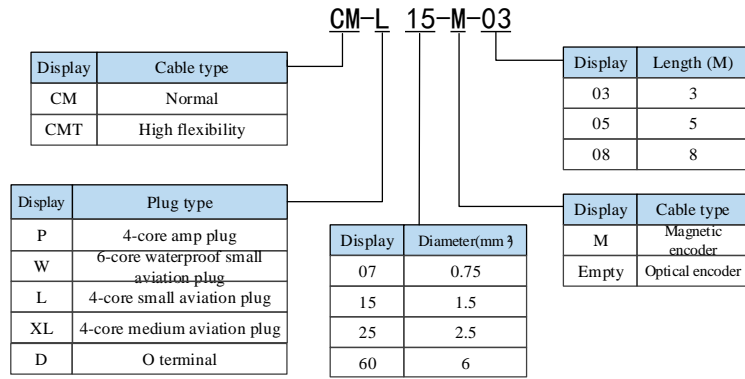

■ Brake cable explanation

- For 80 and below flange motors with suffix S01, the brake cable model shall be selected: CB-P03-length (common material) / CBT-P03-length (high flexible material).
- Suitable for 750W and below motor with suffix S02: CMBT-W07-M-length.
- For the MS5G 130 flange medium inertia brake motor, the cable shall be selected integrated power cable and brake cable type.
- The standard wiring length of Xinje is 2m, 3m, 5m, 8m, 10m, 12m, 16m and 20m.

1.3.2 Description of each part

■ Encoder cable

(1) Pin definition of encoder on servo driver side

Connector appearance	Pin definition	
	No.	Definition
	1	5V
	2	GND
	3	/
	4	/
	5	485+
	6	485-

(2) Cable connection of encoder on motor side

Connector pins	Pin definition		Suitable model
	No.	Definition	
	1	Battery +	40, 60, 80 flange -S01 motor
	2	Battery -	
	3	Shielded cable	
	4	485+	
	5	485-	
	6	/	
	7	5V	
	8	GND	
	9	/	

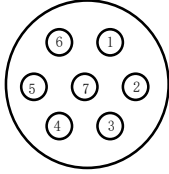
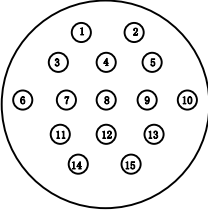
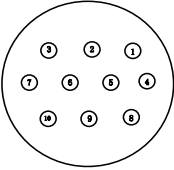
	No.	Definition	40, 60, 80 flange -S02 motor
	1	Shielded cable	
	2	Battery +	
	3	Battery -	
	4	485+	
	5	485-	
	7	5V	
	8	GND	
	No.	Definition	110 and above flange motor
	1	Shielded cable	
	2	/	
	3	485-	
	4	485+	
	5	/	
	6	GND	
	7	Battery -	
	8	5V	
9	Battery +		
Connector pins	Interface definition		Suitable model
	No.	definition	
	1	/	130 flange medium inertia motor
	2	5V	
	3	GND	
	4	485+	
	5	485-	
	6	Battery +	
	7	Battery -	
	8	/	
	9	/	
	10	Shielded cable	

Battery box description:

1) The encoder including the cable definition of battery +, battery- is for the absolute motor, and the non-absolute motor cable has no such pin.



2) Only the cable of absolute value motor has external battery box, which contains a 3.6V/2.7Ah large capacity battery, and has the function of replacing batteries when power cut. The using life is more than two years. Please refer to chapter 5.7.2 change battery.

■ Power cable

(1) Pin definition of power cable on servo driver side

Connector appearance	Pin definition	
	Color	Definition
	Brown	U
	Black	V
	Blue	W
	Yellow-green	PE

(2) Power cable connection on motor side

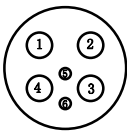
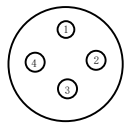
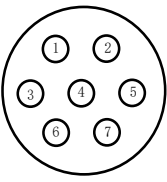
Connector pins	Pin definition		Suitable model
	No.	Definition	
	1	U	40, 60, 80 flange -S01 motor
	2	W	
	3	V	
	4	PE	
	No.	Definition	40, 60, 80 flange -S01 motor brake
	1	BK	
	2	BK	
	No.	Definition	750W and below S02 small aviation plug motor
	1	PE	
	2	U	
	3	V	
	4	W	
	5	BK	
6	BK		
	No.	Definition	110 and above motor (include 130 flange medium inertia motor without brake)
	1	PE	
	2	U	
	3	V	
	Interface definition		130 flange medium motor with brake
	No.	Definition	
	1	PE	
	2	U	
	3	V	
	4	W	
	5	BK+	
	6	BK-	
7	/		

Brake pins:

The cable including BK pin is used for the brake motor. The cable of the non-brake motor has no BK pin.

1.4 Selection of other accessories

1.4.1 Selection of regenerative resistance

When the servo motor is driven by the generator mode, the power returns to the servo amplifier side, which is called regenerative power. The regenerated power is absorbed by charging the smooth capacitor of the servo amplifier. After exceeding the rechargeable energy, the regenerative resistance is used to consume the regenerative power.

The servo motor driven by regenerative (generator) mode is as follows:

- The deceleration stop period during acceleration and deceleration operation;
- Running vertically and axially;
- When the external load drives the motor to rotate.

Servo driver model	Regenerative resistance connection terminals
DS5□-□□P□-PTA	<p>(1) Using built-in regenerative resistance, short P + and D terminals, P + and C are disconnected.</p> <p>(2) Use external regenerative resistance, connect regenerative resistance to P + and C terminals, remove P + and D short wiring, P0-25 = power value, P0-26 = resistance value.</p> <p>Note: if software version U2-07 < 3700, the parameter P0-24 should be set. The value of 0 is for the built-in resistance to take effect, and the value of 1 is for the external resistance to take effect.</p>

The following table is the recommended specifications of external regenerative resistance for each type of motor.

Servo driver model	Rmin (Not less than this value)	External regenerative resistance (Recommended resistance value)	External regenerative resistance (Recommended power values)
DS5F-20P1-PTA	50Ω	50Ω-100Ω	Above 200W
DS5F-20P2-PTA			
DS5F-20P4-PTA	40Ω	40Ω-100Ω	Above 500W
DS5F-20P7-PTA			
DS5F-21P5-PTA	25Ω	25Ω-50Ω	Above 1000W
DS5F-22P3-PTA			
DS5F-22P6-PTA			
DS5F-43P0-PTA	55Ω	55Ω - 75Ω	Above 1000W
DS5F-45P5-PTA	25Ω	25Ω - 65Ω	Above 2000W
DS5F-47P5-PTA	25Ω	25Ω - 50Ω	Above 2000W

Note:

(1) The smaller the resistance is, the faster the discharge will be, but the smaller the resistance is, the easier the breakdown resistance will be. Therefore, please close to the the lower limit but not be less than the lower limit when choosing the type.

(2) When wiring, please use high-temperature flame-retardant wire, and the regenerative resistance surface can not contact with the wire.

2 Installation of servo system

2.1 Servo driver installation

2.1.1 Installation site

- Please install it in the installation cabinet without sunshine or rain.
- Do not use this product near corrosive and flammable gas environments such as hydrogen sulfide, chlorine, ammonia, sulfur, chlorinated gas, acid, alkali, salt, etc.
- Do not install in high temperature, humidity, dust, metal dust environment;
- No vibration place.

2.1.2 Environment condition

Item	Description
Use ambient temperature	-10~40°C
Use ambient humidity	-20~90%RH (no condensation)
Storage temperature	-20~60°C
Storage humidity	-20~90%RH (no condensation)

2.1.3 Installation standard

Be sure to comply with the installation standard in the control cabinet shown in the figure below. This standard is applicable to the situation where multiple servo drivers are installed side by side in the control cabinet (hereinafter referred to as "when installed side by side").

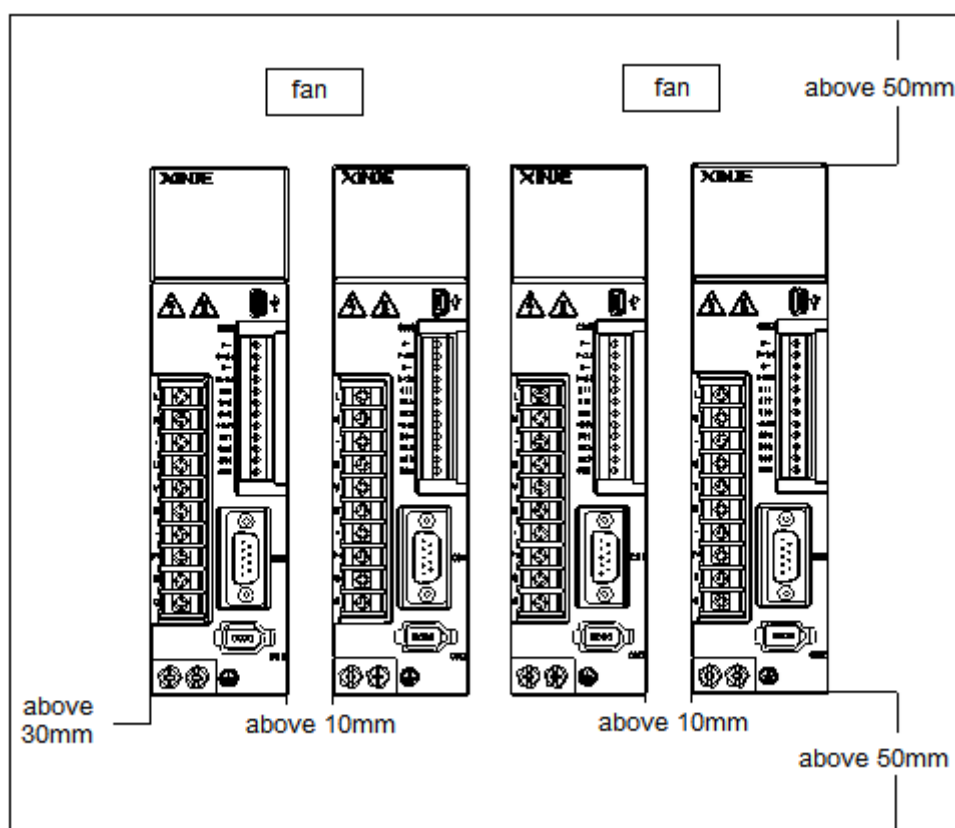

■ Servo Drive Orientation

Install the servo drive perpendicular to the wall so the front panel containing connectors faces outward.

■ Cooling

As shown in the figure above, allow sufficient space around each servo drive for cooling by cooling fans or natural convection.

■ Side-by-side Installation

When install servo drives side by side as shown in the figure above, make at least 10mm between and at least 50mm above and below each servo drive. Install cooling fans above the servo drives to avoid excessive temperature rise and to maintain even temperature inside the control panel.

■ Environmental Conditions in the Control Panel

- Servo driver working ambient Temperature: -10~40 °C
- Humidity: 90%RH or less
- Vibration: 4.9m/s²
- Condensation and Freezing: None
- Ambient Temperature for Long-term Reliability: 50 °C maximum

2.2 Servo motor installation

MS series servomotors can be installed either horizontally or vertically. The service life of the servomotor can be shortened or unexpected problems might occur if it is installed incorrectly or in an inappropriate location. Follow these installation instructions carefully.

**CAUTION**

1. The end of the motor shaft is coated with antirust. Before installing, carefully remove all of the paint using a cloth moistened with paint thinner.
2. Avoid getting thinner on other parts of the servo motor.

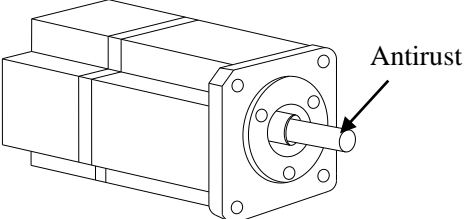

2.2.1 Environment condition

When used in places with water droplets or oil droplets, the protection effect can be achieved through the treatment of motors. However, in order to seal the through part of the shaft, please specify the motor with oil seal. Connectors should be installed downward.

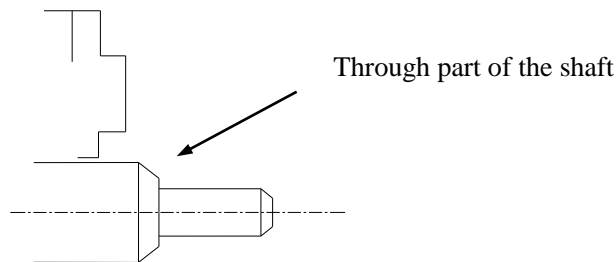

MS series servo motors are for indoor use. Please use them under the following installation conditions:

Item	Description
Use ambient temperature	-10°C~40°C (no freeze)
Use ambient humidity	20%~90%RH (no condensation)
Storage temperature	-20°C~60°C
Storage humidity	-20%~90%RH (no condensation)
Protection level	IP65

2.2.2 Installation cautions

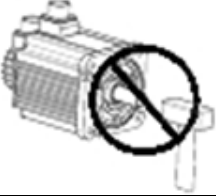
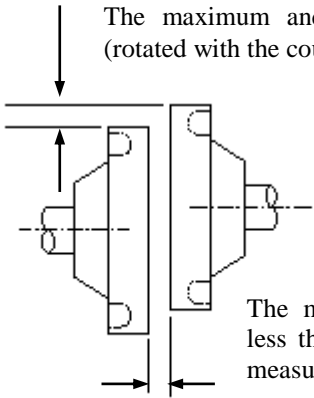
Item	Description
Antirust treatment	<ul style="list-style-type: none"> ◆ Before installation, please wipe the "rust-proof agent" of the extension end of the servo motor shaft, and then do the relevant rust-proof treatment.
Encoder cautions	<ul style="list-style-type: none"> ◆ It is forbidden to impact the extension end of the shaft during installation, otherwise the internal encoder will be broken. 
	<ul style="list-style-type: none"> ◆ When the pulley is installed on the servo motor shaft with keyway, the screw hole is used at the end of the shaft. In order to install the pulley, the double-headed nails are inserted into the screw holes of the shaft, the washer is used on the surface of the coupling end, and the pulley is gradually locked with the nut. ◆ For the servo motor shaft with keyway, use the screw hole at the end of the shaft to install. For shaft without keyway, friction coupling or similar methods are used. ◆ When the pulley is dismantled, the pulley mover is used to prevent the bearing from being strongly impacted by the load. ◆ To ensure safety, protective covers or similar devices, such as pulleys installed on shaft, are installed in the rotating area.
Centering	<ul style="list-style-type: none"> ◆ When installing the servo motor, make it conform to the centering accuracy requirement shown in the picture below. If the centering is inadequate, vibration will occur, and sometimes the bearing and encoder may be damaged. When installing the coupling, please do not directly impact the motor shaft, otherwise the encoder installed on the opposite side of the load shaft will be damaged. 
Installation direction	<ul style="list-style-type: none"> ◆ Servo motor can be installed in horizontal or vertical direction.

Oil and water solutions	<p>When using in places where water droplets are dropping, please use it on the basis of confirming the protection level of servo motor. (except for the shaft-through part) When oil droplets will drip into the shaft-through part, please specify the servo motor with oil seal.</p> <p>Conditions for use of servo motors with oil seals:</p> <ul style="list-style-type: none"> ◆ Make sure the oil level is below the lip of the oil seal when using. ◆ Please use the oil seal to keep the splash of oil droplets in good condition. ◆ When the servo motor is installed vertically upward, please pay attention not to oil accumulation on the lip of the oil seal.
Stress state of cable	<ul style="list-style-type: none"> ◆ Do not "bend" or apply "tension" to the wire, especially the core of the signal line is 0.2mm or 0.3mm, very thin, so when wiring (using), do not make it too tight.

Item	Description
Processing of Connector Part	<p>For the connector part, please pay attention to the following items:</p> <ul style="list-style-type: none"> ◆ When connecting the connector, please make sure that there is no foreign matter such as garbage or metal sheets in the connector. ◆ When connecting the connector to the servo motor, it is necessary to connect the connector from the side of the main circuit cable of the servo motor first, and the grounding wire of the main cable must be connected reliably. If one side of the encoder cable is connected first, the encoder may fail due to the potential difference between PE. ◆ When wiring, please make sure that the pins are arranged correctly. ◆ Connectors are made of resin. Do not apply shock to avoid damaging the connector. ◆ When carrying out the operation under the condition that the cable remains connected, it is necessary to grasp the main body of the servo motor. If only the cable is seized for handling, it may damage the connector or pull the cable off. ◆ If bending cable is used, full attention should be paid to the wiring operation and stress should not be applied to the connector part. If the stress is applied to the connector part, the connector may be damaged.

2.2.3 Installation environment

- Do not use this product near corrosive and flammable gas environments such as hydrogen sulfide, chlorine, ammonia, sulfur, chlorinated gas, acid, alkali, salt, etc.
- In places with grinding fluid, oil mist, iron powder, cutting, etc., please choose motor with oil seal.
- A place away from heat sources such as stoves;
- Do not use motor in enclosed environment. Closed environment will lead to high temperature and shorten service life of motor.

2.3 Servo cable installation

DS5 series servo motor adopts communication encoder, which may cause uncertain influence due to improper use and environmental factors. When installing power cable and encoder cable, please pay attention to the following instructions.

2.3.1 Cable selection

Our regular cable materials include ordinary cable and high flexible cable. The adapter cable connector for motors with 80 flange or less is divided into aviation plug and amp plug; the adapter cable connector for motors with 80 flange or more is aviation plug.

The cable selected by the customer needs to define the operating conditions on site.

If the cable is used in general occasions, please select the cable from other manufacturers (2.3.2 specifications of Xinje cable) in strict accordance with the specifications given by Xinje. If the cable is used in unconventional occasions, please select the cable according to the actual working conditions to be superior to the existing specifications of Xinje.

1. In normal situations, the following points should be noted:

- For pulse command signal cable, please ensure wiring less than 3m.
- The encoder cable shall be within 20 meters. It is recommended to select special cable if it is more than 20 meters. The wire diameter of encoder cable depends on the length of encoder cable used on site. The longer the cable is, the greater the wire resistance is, and the more severe the voltage attenuation or signal distortion is, which is likely to cause pulse loss or no signal can be detected. Therefore, in general, the customized special cable should be selected if it is more than 20 meters.
- The power cable diameter depends on the current condition of the motor. Generally, the wire diameter is 1/10 of the maximum current of the motor. For example, the maximum current of the motor is 60A, and the wire diameter of 6mm² is selected.
- In case of interference, it is necessary to separate strong and weak current. It is recommended to separate power cable from encoder cable and signal cable.
- Ensure the correct grounding of servo driver and servo motor. The grounding resistance is not more than 4Ω, and the grounding depth is more than 2m. It is recommended to use 4*40 angle galvanized steel or 40mm diameter galvanized steel pipe;
- If the customer makes the wire by himself, the cable specification please refer to chapter 2.3.2 Xinje cable specification, the welding reliability shall be ensured when making the wire to avoid false welding, bridge connection, wrong welding, missing welding, etc., and the continuity of both ends of the cable can be tested after the welding is completed.

2. In unconventional occasions, the following items shall be noted:

(1) Occasions of dragging and bending cables

- Do not bend the cable or bear the tension. As the core diameter of signal cable is only 0.2mm or 0.3mm, it is easy to break, please pay attention to it when using.
- When the cable needs to be moved, please use flexible cable. Ordinary cable is easy to be damaged after long-term bending. Small power motor (motor below 80 flange) with its own cable can not be used for cable movement.
- When using cable protection chain, please ensure that:
 - ① The bending radius of the cable is more than 10 times of the outer diameter of the cable;
 - ② The wiring in the cable protection chain shall not be fixed or bundled, only the two immovable wires end in the cable protection chain shall be bound and fixed;
 - ③ Do not twist the cable;
 - ④ The duty cycle in the cable protection chain shall be less than 60%;
 - ⑤ Do not mix the cables with too big difference in appearance. The thin wire will be broken by the thick wire. If it is necessary to mix the wiring, partition device is arranged in the middle of the cable.

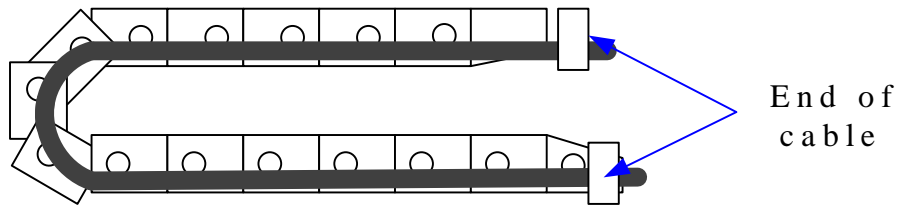

- (2) Greasy and humid occasions
 - It is recommended to select cable with aviation plug as connector instead of AMP interface cable.
 - It is necessary to make corresponding protection (glass glue/insulating cloth binding, etc.) for the used AMP interface cable on site.
 - Use special cable.
- (3) Interference, high current / high power occasions (such as welding equipment)
 - The motor is properly grounded.
 - High current equipment shall be grounded separately.
 - Reasonable wiring. Such as separation of strong and weak current cables.
 - Use metal shielding layer to shield, add magnetic ring to the encoder cable to resist interference.
- (4) Low / high temperature
 - Select cables (special cables) that meet the use conditions.

2.3.2 Xinje cable specification

1. Material composition of Xinje cable

Cross section of cable (encoder, power cable), corresponding introduction of wire skin material, wire diameter, wire core material shielding material, etc.

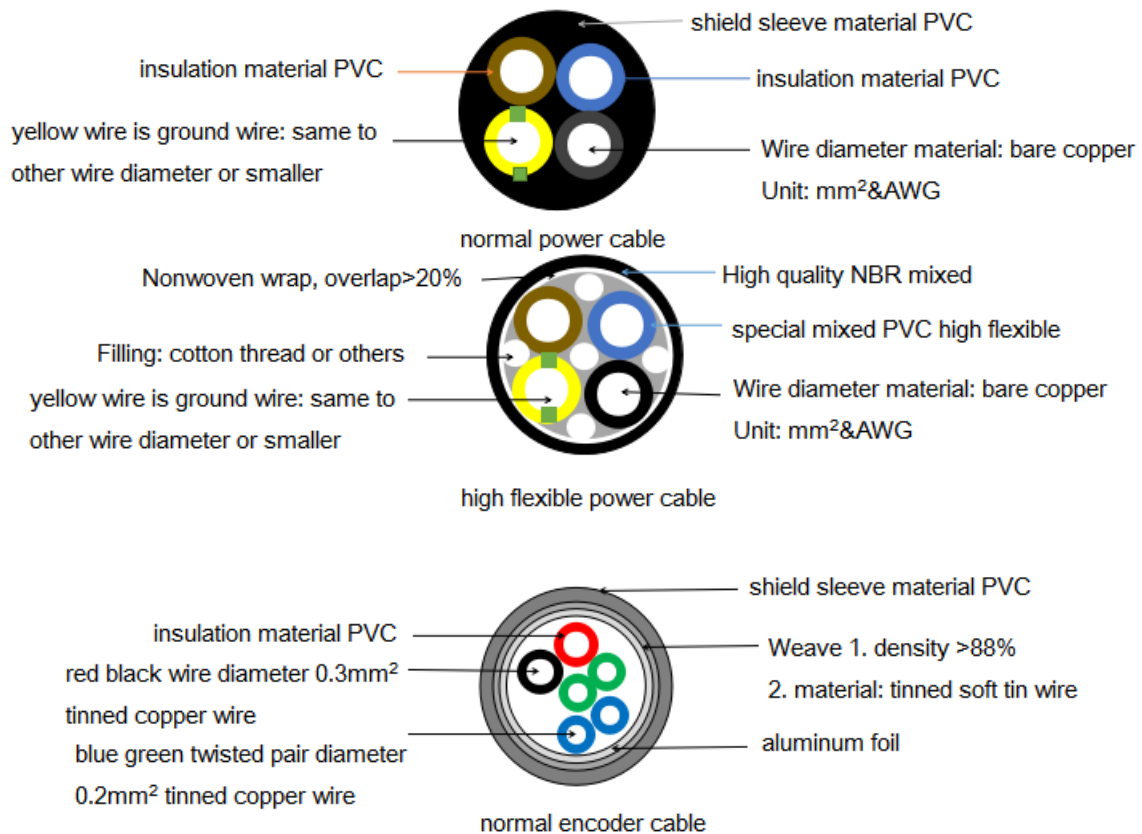

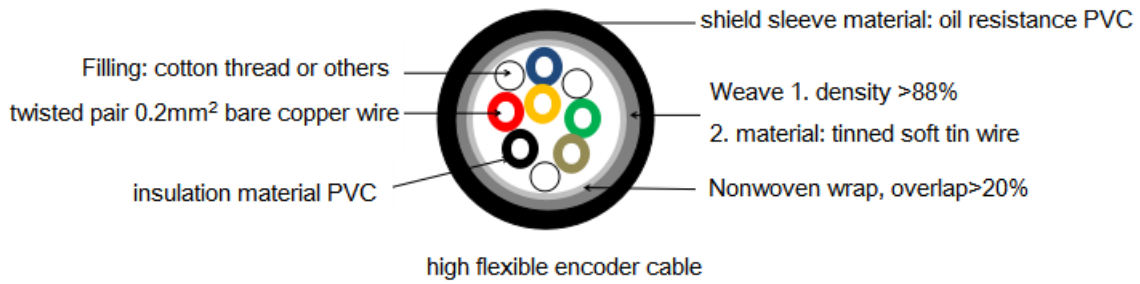

2. Cable diameter specification

power \ type	Encoder cable	Power cable
100W	4*0.2mm 2*0.3mm ²	4*0.75mm ²
200W	4*0.2mm 2*0.3mm ²	4*0.75mm ²
400W	4*0.2mm 2*0.3mm ²	4*0.75mm ²
750W	4*0.2mm 2*0.3mm ²	4*0.75mm ²
1.5KW	4*0.2mm 2*0.3mm ²	4*1.5mm ²
3.0KW	4*0.2mm 2*0.3mm ²	4*2.5mm ²
5.5KW	4*0.2mm 2*0.3mm ²	3*6.0mm 1*2.5mm ²
7.5KW	4*0.2mm 2*0.3mm ²	3*6.0mm 1*2.5mm ²
11KW	4*0.2mm 2*0.3mm ²	3*6.0mm 1*2.5mm ²
15KW	4*0.2mm 2*0.3mm ²	3*6.0mm 1*2.5mm ²
22KW	4*0.2mm 2*0.3mm ²	3*8mm 1*4mm ²
32KW	4*0.2mm 2*0.3mm ²	3*12mm 1*4mm ²

3. Cable performance specification

Performance		Normal cable	High flexible cable
Ordinary temperature resistance		-20°C~80°C	-20°C~80°C
Encoder cable withstand voltage		1000V/min	1000V/min
Power cable withstand voltage		3000V/min	3000V/min
Mobile installation	Bending radius	Travel <10m, 7.5*D; Travel ≥10m, 10*D;	Travel <10m, 7.5*D; Travel ≥10m, 10*D;
	Bending resistance times	Travel <10m, ≥1 million times; Travel ≥10m, ≥2 million times;	Travel <10m, ≥3 million times; Travel ≥10m, ≥5 million times;
Fixed installation	Bending radius	5*D	5*D

Note: D represents the finished product cable diameter.

2.4 Servo driver dimension

- DS5F-20P1-PTA, DS5F-20P2-PTA, DS5F-20P4-PTA

Unit: mm

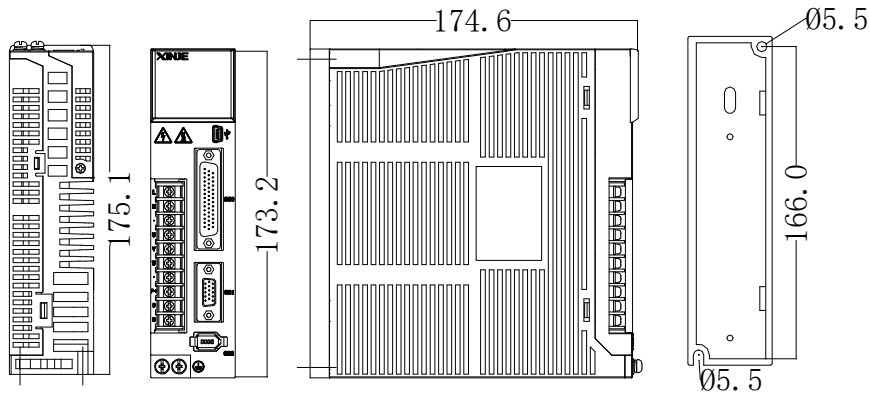

- DS5F-20P7-PTA

Unit: mm

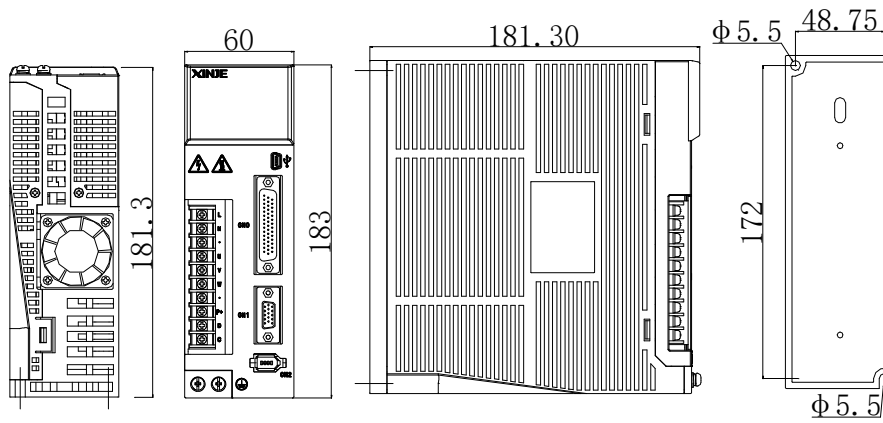

- DS5F-21P5-PTA, DS5F-22P3-PTA, DS5F-22P6-PTA

Unit: mm

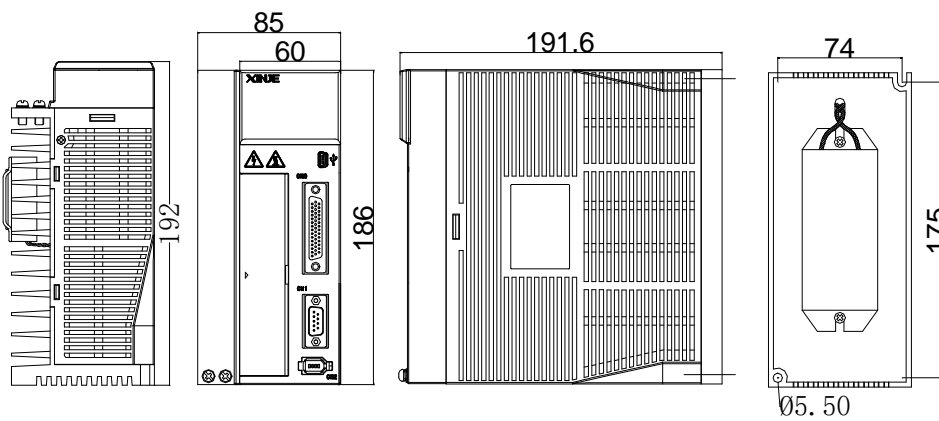

■ DS5F-43P0-PTA

Unit: mm

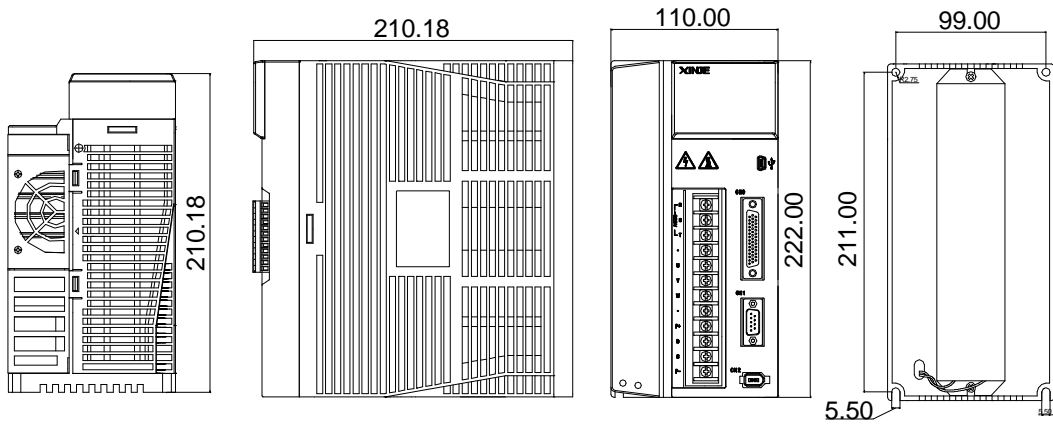

■ DS5F-45P5-PTA / DS5F-47P5-PTA

Unit: mm

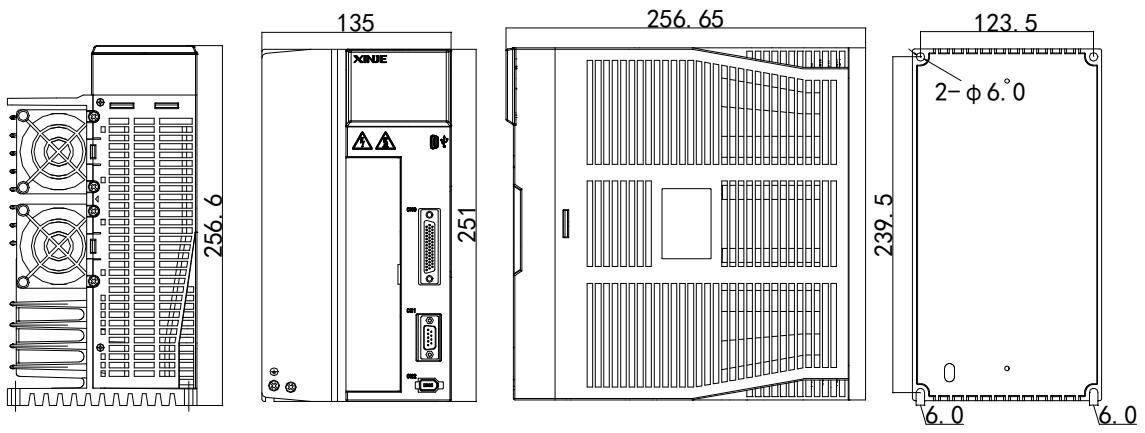

2.5 Servo motor dimension

40 series motor installation dimensions Unit: mm

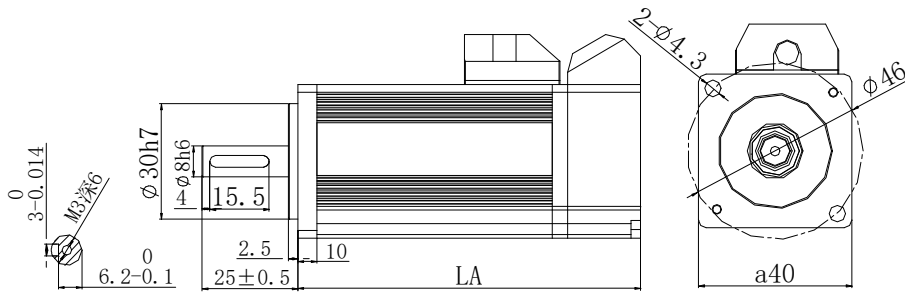

Motor model	LA ± 1		Inertia level
	Normal	With brake	
MS5S-40ST-C□00330□□-20P1-S01/S02	89.5	119	Low inertia

60 series motor installation dimensions Unit: mm

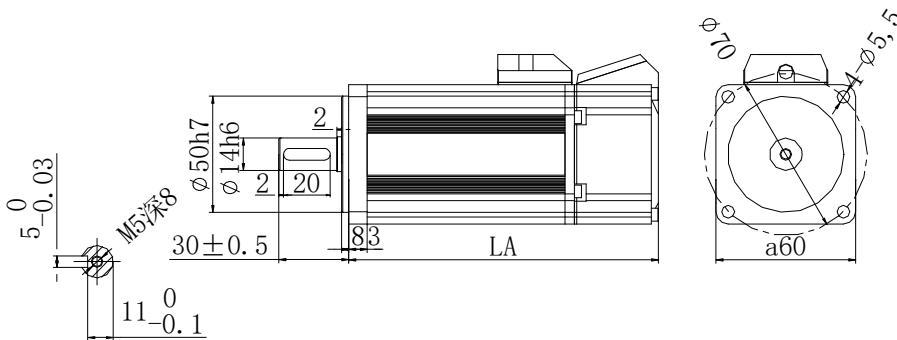

Motor model	LA ± 1		Inertia level	Series
	Normal	With brake		
MS5S-60ST-C□00630□□-20P2-S01/S02	79	114	Low inertia	MS5 series
MS5S-60ST-C□01330□□-20P4-S01/S02	99	134		
MS5H-60ST-C□00630□□-20P2-S01/S02	91	126	High inertia	
MS5H-60ST-C□01330□□-20P4-S01/S02	111	146		
MS-60ST-T01330-20P4-D01	145	189	-	
MS6H-60C□301B□1-20P4	119	151	High inertia	MS6 series

Note: MS5H shaft key is closed key, MS6 motor shaft key is open key.

80 series motor installation dimensions Unit: mm

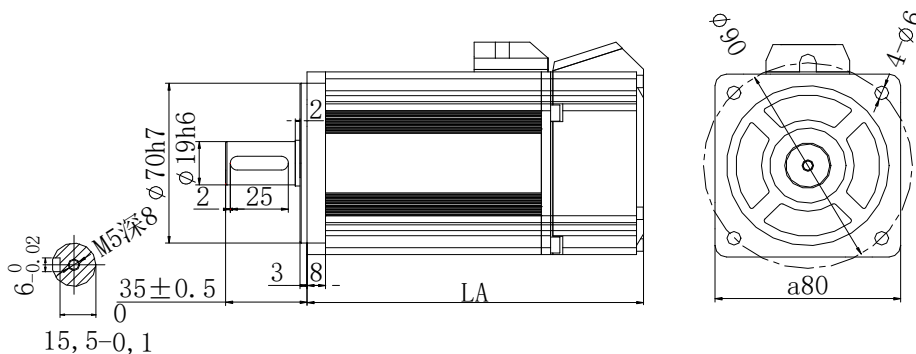

Motor model	LA±1		Inertia level	Series
	Normal	With brake		
MS5S-80ST-C□02430□□-20P7-S01/S02	107	144	Low inertia	MS5 series
MS5S-80ST-C□03230□□-21P0-S01/S02	128	165		
MS5H-80ST-C□02430□□-20P7-S01/S02	119	156	High inertia	
MS5H-80ST-C□03230□□-21P0-S01/S02	140	177		
MS-80ST-T02430□□-20P7	150	199	-	
MS-80ST-T03520□□-20P7	179	219		
MS6H-80C□30B□1-20P7	124	157	High inertia	MS6 series

Note: MS5H shaft key is closed key, MS6 motor shaft key is open key.

■ 110 series motor installation dimensions Unit: mm

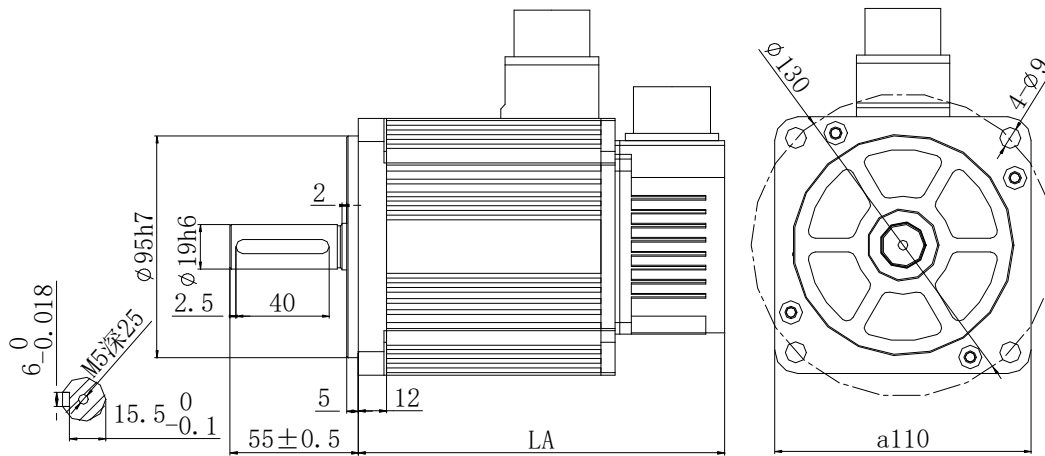

Motor model	LA±1		Inertia level
	Normal	With brake	
MS5S-110ST-C□03230□□-21P0-S01	157	205	Low inertia
MS5S-110ST-C□04830□□-21P5-S01	166	214	
MS5S-110ST-C□06030□□-21P8-S01	181	229	
MS5S-110ST-TL03230□□-21P0-S01	157	205	
MS5S-110ST-TL04830□□-21P5-S01	166	214	
MS-110ST-TL06030□□-21P8-S01	181	229	
MS-110ST-T04030B-21P2	157	205	-
MS-110ST-T05030B-21P5	166	214	

■ 130 series motor installation dimensions Unit: mm

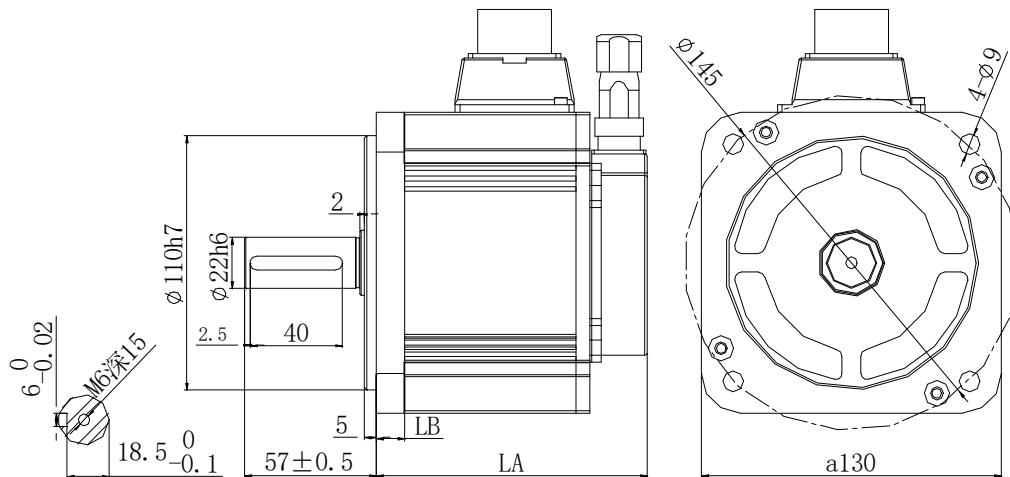

Motor model	LA±1		LB	Inertia level
	Normal	With brake		
MS5G-130STE-C□05415□□-20P8-S01	117.5	147.0	12.5	Middle inertia
MS5G-130STE-C□06025B-21P5-S01	122	-		
MS5G-130STE-C□07220□□-21P5-S01	132.5	162.5		
MS5G-130STE-C□10015B-21P5-S01	145	-		
MS5G-130STE-C□11515□□-21P8-S01	159.5	189.5		
MS5G-130STE-C□11515□□-41P8-S01				
MS5G-130STE-C□14615□□-22P3-S01	180.5	210.5		
MS5G-130STE-C□14615□□-42P3-S01	180.5	210.5		
MS5G-130STE-TL05415□□-20P8-S01	134.5	164.5		
MS5G-130STE-TL07220□□-21P5-S01	149.5	179.5		
MS5G-130STE-TL11515□□-21P8-S01	176.5	206.5		
MS5G-130STE-TL11515□□-41P8-S01				
MS5G-130STE-TL14615□□-22P3-S01	197.5	227.5		
MS5G-130STE-TL14615□□-42P3-S01				
MS-130ST-T04030B-21P2	164	223	14	-
MS-130ST-T06025□□-21P5	179	238		
MS-130ST-T10015□□-21P5	205	264		
MS-130STE-T07730□□-22P4	205	264		
MS-130ST-T15015G□□-22P3	235	294		
MS-130ST-TL10025□□-22P6	209	290		
MS-130ST-TL10030□□-43P0	225	284		

■ 180 series motor installation dimensions Unit: mm

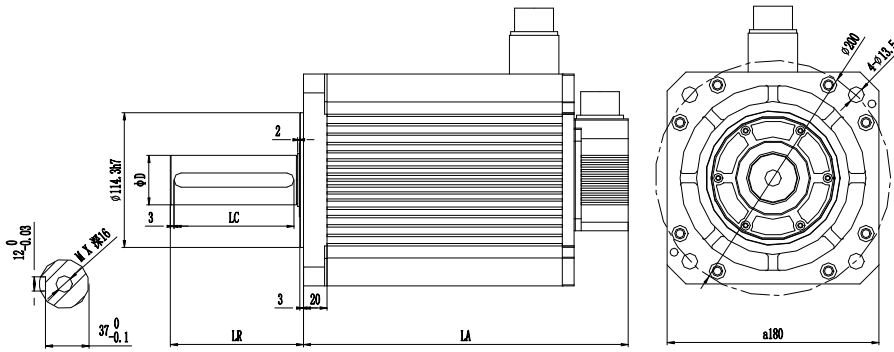

Motor model	LA ± 1		LC ± 0.5	X	ϕD	Inertia level
	Normal	With brake				
MS5G-180ST-TL19015□□-42P9-S01	221	303	79	12	35	Medium inertia
MS5G-180ST-TL28015□□-44P4-S01	247	329				
MS5G-180ST-TL35015□□-45P5-S01	277	359	113	16	42	
MS5G-180ST-TL48015□□-47P5-S01	318	400				

3 Wiring of servo system

Servo driver interface wiring recommended wire, as shown in the following table:

Servo driver model	Power cable diameter mm ²	UVW power cable diameter mm ²	Encoder cable diameter mm ²	Ground cable diameter mm ²
DS5F-20P1-PTA	2.0	0.75	0.2 (7-core)	2.0
DS5F-20P2-PTA	2.0	0.75	0.2 (7-core)	2.0
DS5F-20P4-PTA	2.0	0.75	0.2 (7-core)	2.0
DS5F-20P7-PTA	2.0	0.75	0.2 (7-core)	2.0
DS5F-21P5-PTA	2.0	1.5	0.2 (7-core)	2.0
DS5F-22P3-PTA	2.0	1.5	0.2 (7-core)	2.0
DS5F-22P6-PTA	2.0	1.5	0.2 (7-core)	2.0
DS5F-43P0-PTA	2.0	2.5	0.2 (7-core)	2.0
DS5F-45P5-PTA	6.0	6.0	0.2 (7-core)	6.0
DS5F-47P5-PTA	6.0	6.0	0.2 (7-core)	6.0

Note:

- (1) Please do not cross power wires and signal wires from the same pipeline, nor tie them together. When wiring, please keep the power wire and signal wire more than 30 cm apart.
- (2) For the signal wire and the feedback wire of the encoder (PG), please use the multi-stranded wire and the multi-core stranded integral shielding wire.
- (3) For wiring length, the longest instruction input wire is 3m and the longest PG feedback wire is 20m.
- (4) Even if the power supply is off, there may still be a high voltage in the servo unit. Please do not touch the power terminal temporarily (10 minutes).
- (5) Do not turn ON/OFF power frequently. When the ON or OFF power supply needs to be repeatedly connected, please control it less than once in 2 minutes. Because of the capacitance in the power supply of the servo driver, a large charging current (charging time of 0.2 seconds) will flow through when the power supply is ON. Therefore, if the ON/OFF power supply is frequently used, the performance of the main circuit components in the servo driver will be degraded.

3.1 Main circuit wiring

3.1.1 Servo driver terminal arrangement

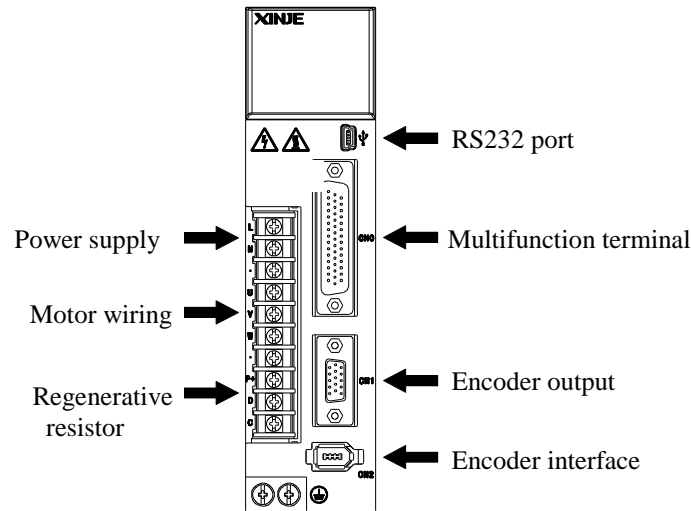

3.1.2 Main circuit terminals

■ DS5F-20P1-PTA, DS5F-20P2-PTA, DS5F-20P4-PTA, DS5F-20P7-PTA

Terminal	Function	Explanation
L/N	Power supply input of main circuit	Single phase AC 200~240V, 50/60Hz
•	Vacant terminal	-
U, V, W	Motor terminals	Connect the motor Note: the ground wire is on the cooling fin, please check it before power on!
P+, D, C	Internal regenerative resistor	Short P+ and D, disconnect P+ and C
	External regenerative resistor	Connect regenerative resistor between P+ and C, disconnect P+ and D, P0-25= power value, P0-26= resistor value

■ DS5F-21P5-PTA, DS5F-22P3-PTA, DS5F-22P6-PTA

Terminal	Function	Explanation
R/S/T	Power supply input of main circuit	3-phase (R,S,T) AC200~240V, 50/60Hz Single phase (R,T) AC200~240V, 50/60Hz
•	Vacant terminal	-
U, V, W	Motor terminals	Connect the motor Note: the ground wire is on the cooling fin, please check it before power on!
P+, D, C	Internal regenerative resistor	Short P+ and D, disconnect P+ and C
	External regenerative resistor	Connect regenerative resistor between P+ and C, disconnect P+ and D, P0-25= power value, P0-26= resistor value
⊕	Ground terminal	Connect to ground terminal of motor, then connect to the ground

■ DS5F-43P0-PTA

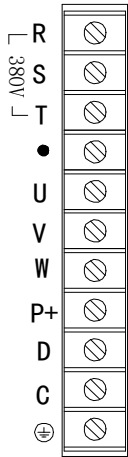

Terminal	Function	Explanation
R/S/T	Power supply input of main circuit	3-phase AC 200~240V, 50/60Hz
●	Vacant terminal	-
U, V, W	Motor terminals	Connect the motor Note: the ground wire is on the cooling fin, please check it before power on!
P+, D, C	Internal regenerative resistor	Short P+ and D, disconnect P+ and C
	External regenerative resistor	Connect regenerative resistor between P+ and C, disconnect P+ and D, P0-25= power value, P0-26= resistor value
⊕	Ground terminal	Connect to ground terminal of motor, then connect to the ground

■ DS5F-45P5/47P5-PTA

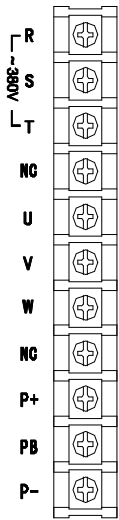

Terminal	Function	Explanation
R/S/T	Power supply input of main circuit	3-phase AC 340~420V, 50/60Hz
●	Vacant terminal	-
U, V, W	Motor terminals	Connect the motor Note: the ground wire is on the cooling fin, please check it before power on!
P+, D, C	Internal regenerative resistor	Short P+ and D, disconnect P+ and C
	External regenerative resistor	Connect regenerative resistor between P+ and C, disconnect P+ and D, P0-25= power value, P0-26= resistor value
P+, P-	Bus terminal	Real-time bus voltage can be measured. Please pay attention to the danger.

3.1.3 CN0, CN1, CN2 terminal

3.1.3.1 CN0 terminal

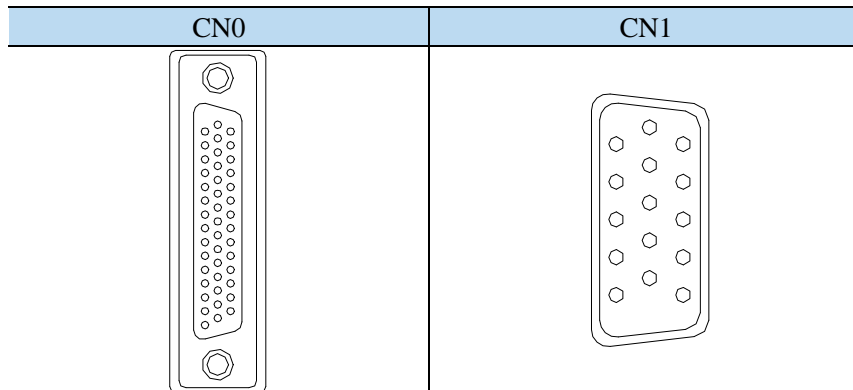

■ CN0 terminal explanation (hardware version V3.1.31 and early)

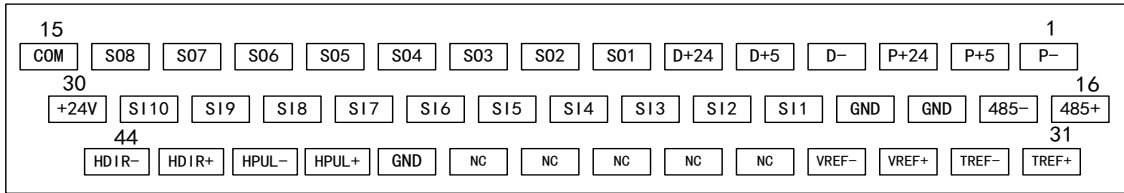

No.	Name	Explanation	No.	Name	Explanation
1	P-	Pulse -	23	SI4	Input terminal
2	P+5	Pulse +5v	24	SI5	Input terminal
3	P+24	Pulse +24v	25	SI6	Input terminal
4	D-	Direction -	26	SI7	Input terminal
5	D+5	Direction +5v	27	SI8	Input terminal
6	D+24	Direction +24v	28	SI9	Input terminal
7	SO1	Output terminal	29	SI10	High speed input terminal
8	SO2	Output terminal	30	+24V	Input common terminal
9	SO3	Output terminal	31	T-REF+	External torque analog differential input +
10	SO4	Output terminal	32	T-REF-	External torque analog differential input -
11	SO5	Output terminal	33	V-REF+	External speed analog differential input +
12	SO6	Output terminal	34	V-REF-	External speed analog differential input -
13	SO7	Output terminal	35	NC	Empty terminal
14	SO8	Output terminal	36	NC	Empty terminal
15	COM	Output common terminal	37	NC	Empty terminal
16	485+	Communication +	38	NC	Empty terminal
17	485-	Communication -	39	NC	Empty terminal
18	GND	Communication ground	40	GND	Line driver signal ground
19	GND	Analog input ground	41	HPUL+	Line driver high speed pulse +
20	SI1	Input terminal	42	HPUL-	Line driver high speed pulse -
21	SI2	Input terminal	43	HDIR+	Line driver high speed direction +
22	SI3	Input terminal	44	HDIR-	Line driver high speed direction -

■ CNO terminal explanation (hardware version V3.1.32 and later)

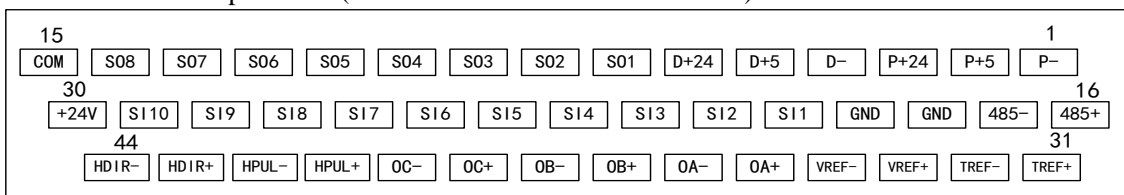

No.	Name	Explanation	No.	Name	Explanation
1	P-	Pulse -	23	SI4	Input terminal
2	P+5	Pulse +5v	24	SI5	Input terminal
3	P+24	Pulse +24v	25	SI6	Input terminal
4	D-	Direction -	26	SI7	Input terminal
5	D+5	Direction +5v	27	SI8	Input terminal
6	D+24	Direction +24v	28	SI9	Input terminal
7	SO1	Output terminal	29	SI10	High speed input terminal
8	SO2	Output terminal	30	+24V	Input common terminal
9	SO3	Output terminal	31	T-REF+	External torque analog differential input +
10	SO4	Output terminal	32	T-REF-	External torque analog differential

					input -
11	SO5	Output terminal	33	V-REF+	External speed analog differential input +
12	SO6	Output terminal	34	V-REF-	External speed analog differential input -
13	SO7	Output terminal	35	OA+	Encoder frequency division output OA+
14	SO8	Output terminal	36	OA-	Encoder frequency division output OA-
15	COM	Output common terminal	37	OB+	Encoder frequency division output OB+
16	485+	Communication +	38	OB-	Encoder frequency division output OB-
17	485-	Communication -	39	OZ+	Encoder frequency division output OZ+
18	GND	Communication ground	40	OZ-	Encoder frequency division output OZ-
19	GND	Analog input ground	41	HPUL+	Line driver high speed pulse +
20	SI1	Input terminal	42	HPUL-	Line driver high speed pulse -
21	SI2	Input terminal	43	HDIR+	Line driver high speed direction +
22	SI3	Input terminal	44	HDIR-	Line driver high speed direction -

3.1.3.2 CN1 terminal

■ CN1 terminals explanation (hardware version V3.1.31 and early)

No.	Name	Explanation	No.	Name	Explanation
1	OA+	Encoder frequency division output A+	9	OZ-	Encoder frequency division output Z-
2	OA-	Encoder frequency division output A-	10	-	Empty terminal
3	OB+	Encoder frequency division output B+	11	-	Empty terminal
4	OB-	Encoder frequency division output B-	12	-	Empty terminal
5	OZ+	Encoder frequency division output Z+	13	-	Empty terminal
6	-	Empty terminal	14	-	Empty terminal
7	-	Empty terminal	15	-	Empty terminal
8	-	Empty terminal			

■ CN1 terminals explanation (hardware version V3.1.32 and later)

No.	Name	Explanation	No.	Name	Explanation
1	Z-	Full closed loop input Z-	9	Z+	Full closed loop input Z+
2	B-	Full closed loop input B-	10	-	Empty terminal
3	B+	Full closed loop input B+	11	-	Empty terminal
4	A+	Full closed loop input A+	12	-	Empty terminal
5	A-	Full closed loop input A-	13	-	Empty terminal
6	GND	Grating ruler GND	14	-	Empty terminal
7	GND	Grating ruler GND	15	-	Empty terminal
8	5V	Grating ruler power supply 5V			

3.1.3.3 CN2 terminal

The terminals of the CN2 connector are arranged as follows (faced solder plates):

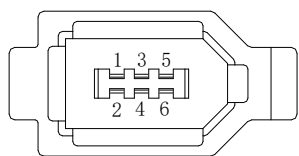

No.	Definition
1	5V
2	GND
3	/
4	/
5	485+
6	485-

3.1.4 Communication port

■ RS-232 communication

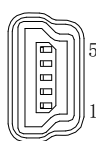

Driver side-5-pin trapezoidal interface

Pin	Name	Description
1	TXD	RS232 send
2	RXD	RS232 receive
3	GND	RS232 signal ground

Note: Please use the dedicated cable provided by XINJE company.

RS232 port default communication parameters: baud rate 19200bps, data bit is 8-bit, stop bit is 1-bit, even parity.

Modbus station no.

Parameter	Function	Default setting	Range	Modification	Effective
P7-10	Modbus station no.	1	1~255	Servo OFF	Immediately

■ RS-485 communication

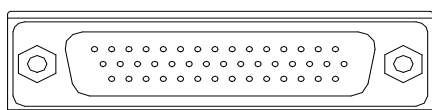

Driver side - CN1 port

Pin	Name
16	A
17	B

RS485 port default parameters: baud rate 19200bps, data bit is 8-bit, stop bit is 1-bit, even parity.

Modbus station no. can be set freely, set by P7-00:

Parameter	Function	Default setting	Range	Modification	Effective
P7-00	Modbus station no.	1	0~255	Servo OFF	Immediately

Note:

- (1) Support the standard Modbus RTU protocol, which is used as the slave device of Modbus RTU.
- (2) RS232 and RS485 communication ports can be used simultaneously.

3.2 Classification and function of signal terminals

3.2.1 Pulse signal

Instruction form	Option	Meaning	P-input signal	D-input signal	Chapter
P0-10 xxx□	0	CW/CCW dual-pulse mode	CW	CCW	5.3.2.2
	1	AB phase mode	A phase	B phase	
	2	Pulse+direction mode	pulse	direction	
Open collector (24V voltage) input signal is P+ (pin 3) / D+ (pin 6)					
Input signal of differential mode (5V voltage) is P+ (pin 2) / D+ (pin 5)					

The wiring diagram of P + D, CW, CCW and AB phase interface circuit is as follows:

Open collector (24V voltage)

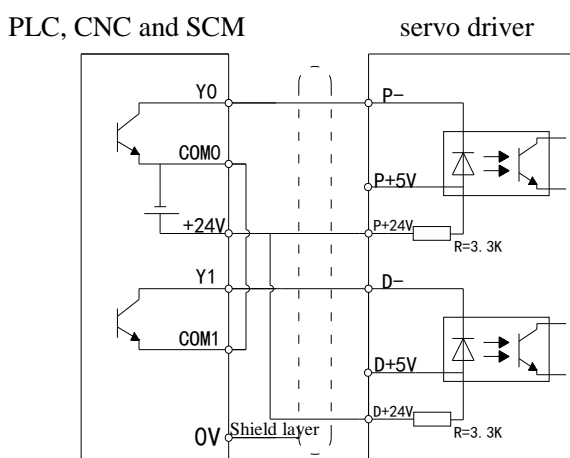

When the upper device adopts collector open circuit output, use this connection method, please pay attention to suspending P+ 5V and D+ 5V.

Note:

- (1) The supply voltage range of P-/P+24V and D-/D+24V is 18V~25V. If it is below 18V, there may be pulse and direction anomalies.
- (2) In order to resist interference, twisted-pair shielding wire must be used.

Differential mode (5V voltage)

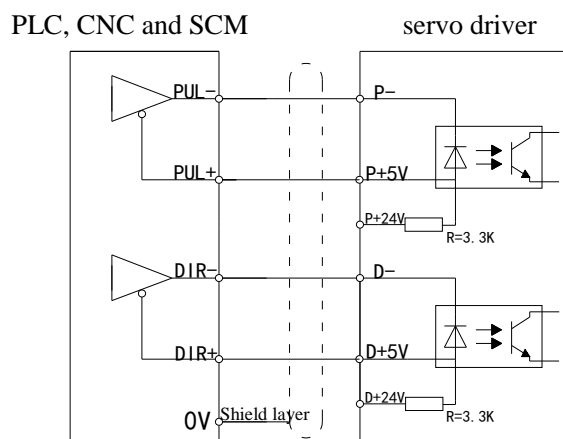

When the upper device uses 5V differential signal output, the graphic connection method is adopted, please pay attention to suspending P+ 24V and D+ 24V.

Note: In order to resist interference, twisted-pair shielding wire must be used.

Line driver pulse wiring method

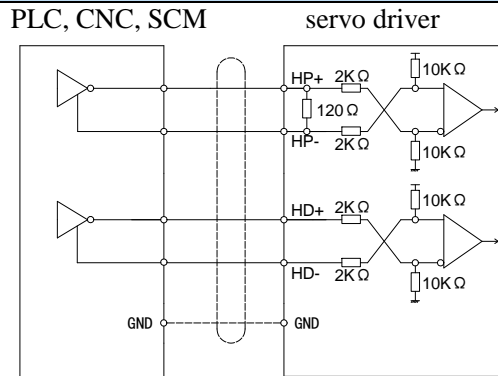

Note:
 (1) It is suggested to add the differential isolation board of Xinje;
 (2) CW/CCW pulse input frequency is 2M at most, and AB phase pulse frequency is 2M at most.

Note: In order to resist interference, twisted-pair shielding wire must be used.

Note:

(1) The power supply voltage range of P- / P+ 24V and D- / D+ 24V is 18V ~ 25V. The power supply voltage range of P- / P+ 5V and D- / D+ 5V is 3.3V ~ 5V. If it is lower than 18V / 3.3V, there may be abnormal pulse and direction.

(2) Servo pulse input port is ON for 10mA.

(3) If the controller is Xinje PLC, the rated current of the pulse output port is 50mA. According to this data, it can be judged that one pulse theoretically can drive at most five servos. It is recommended not to exceed 3.

3.2.2 SI input signal

Please use a relay or an open collector transistor circuit to connect. When using relay connection, please select the relay for small current. If the relay is not small current, it will cause bad contact.

Type	Input terminal	Function
Digital input	SI1~SI10	Multifunctional input signal terminal

Defaulted assignment of input terminals

Terminal	SI1	SI2	SI3	SI4	SI5~SI10
Function	S-ON/ enable	ALM-RST/alarm reset	P-OT/forward run prohibition	N-OT/reverse run prohibition	Not distribute

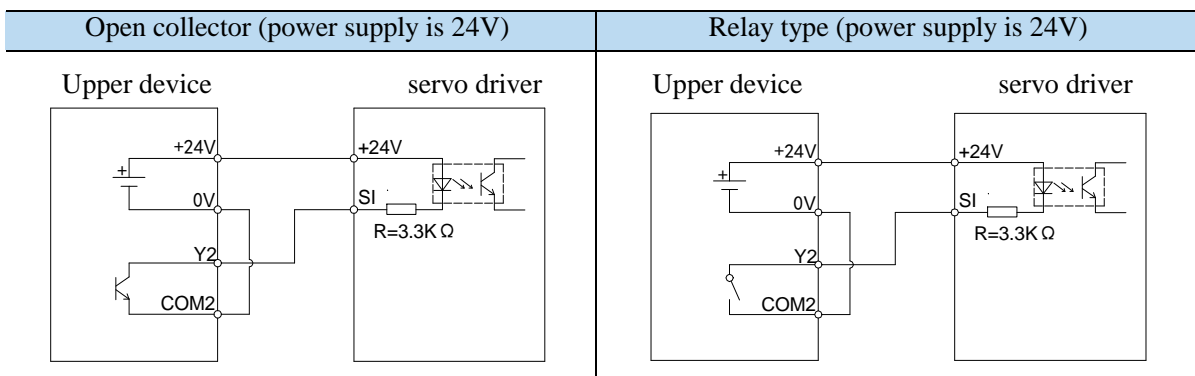

Note: SI10 terminal is high-speed input port, and SI1-SI9 are low-speed input ports.

3.2.3 SO output signal

Type	Output terminal	Function
Optocoupler output	SO1~SO8	Multifunctional output terminal

Defaulted assignment of output terminals

Terminal	SO1	SO2	SO3~SO8
Function	COIN/positioning completion	ALM/alarm	Not distribute

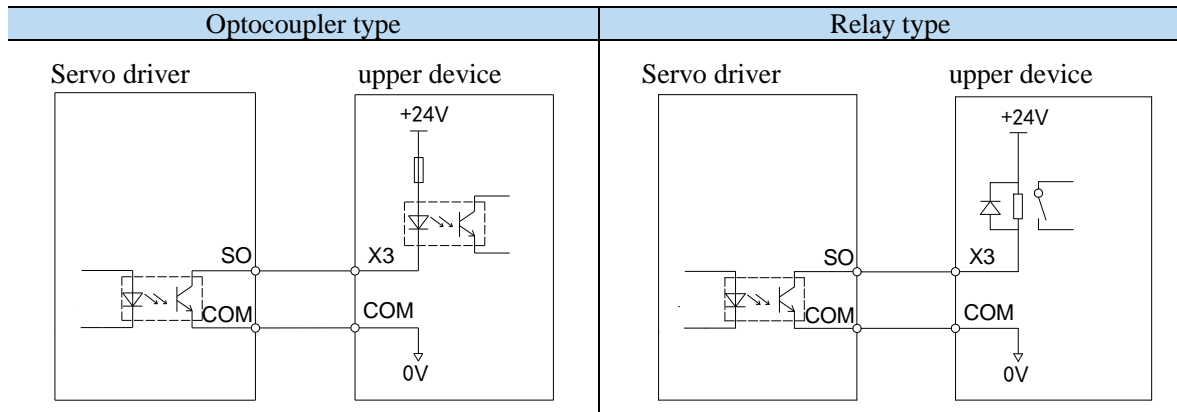

Note: the maximum allowable voltage and current capacity of collector open output circuit are as follows:

- Voltage: DC 30V (maximum)
- Current: SO1 ~ SO2 DC 500mA (maximum)
- SO3 ~ SO8 DC 50mA (maximum)

3.2.4 Analog input circuit

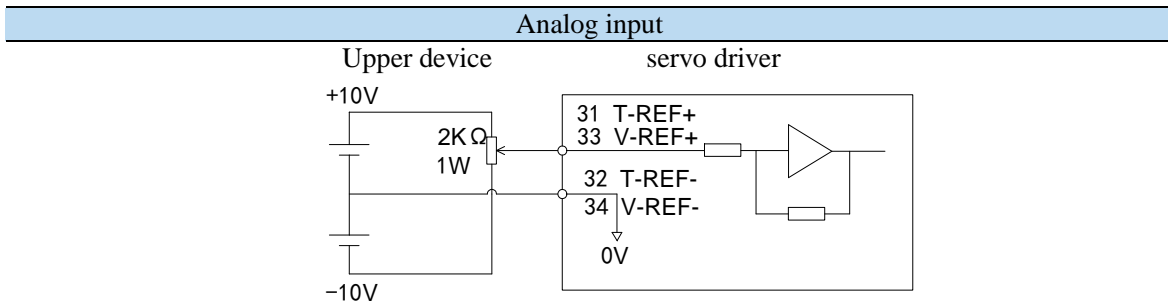

Note: Analog Pin31 (External Torque Analog Differential Input+), 32 (External Torque Analog Differential Input-), 33 (External Speed Analog Differential Input+), 34 (External Speed Analog Differential Input-) are soldered out of the CN0 port as detailed in chapter 3.1.3.1.

Analog signals are speed or torque command signals. The input impedance is as follows:

- * Speed instruction input: about 13K
- * Torque instruction input: about 13K

The maximum allowable voltage of the input signal is $\pm 10V$. Do not apply the voltage above $\pm 10V$.

3.2.5 Encoder feedback output signal

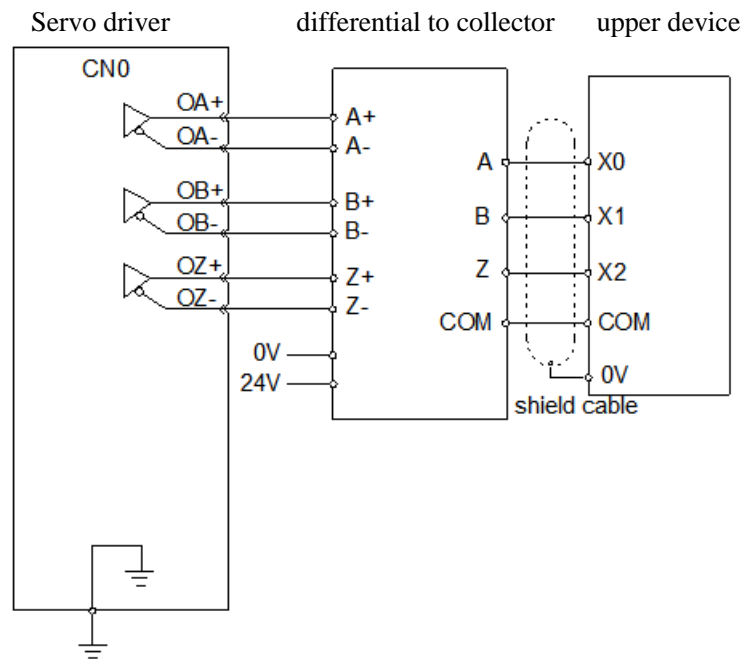

4 Operate panel

4.1 Basic operation

4.1.1 Operating panel description

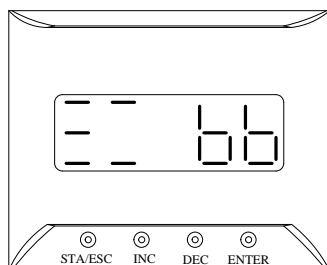

Button	Operation
STA/ESC	Short press: state switch, state return
INC	Short Press: The display data increases Long press: The display data increases continuously
DEC	Short Press: The display data decreases Long press: The display data decreases continuously
ENTER	Short press: shift; Long press: Set and view parameters.

The panel will be self-checked, and all the display digital tubes and five decimal points will be lit for one second at the same time.

4.1.2 Button operation

By switching the basic state of the panel operator, it can display the running state, set parameters, run auxiliary functions and alarm state. After pressing the STA/ESC key, the states are switched in the order shown in the following figure.

State: BB indicates that the servo system is idle; run indicates that the servo system is running; RST indicates that the servo system needs to be re-energized.

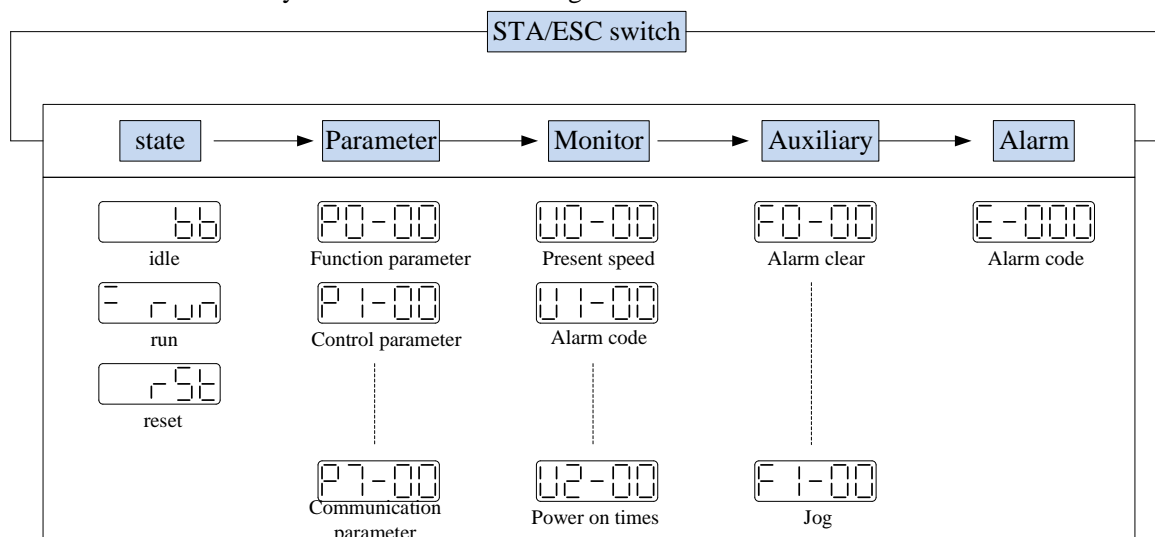

- Parametric setting Px-xx: The first X represents the group number, and the last two X represents the parameter serial number under the group.
- Monitor status Ux-xx: The first X represents the group number, and the last two X represents the parameter number under the group.
- Auxiliary function Fx-xx: The first X denotes the group number, and the last two X denotes the parameter number under the group.
- Alarm state E-xxx: The first two X denote the alarm category, and the last x denotes the small category under the category.

4.2 Operation display

■ Speed torque control mode

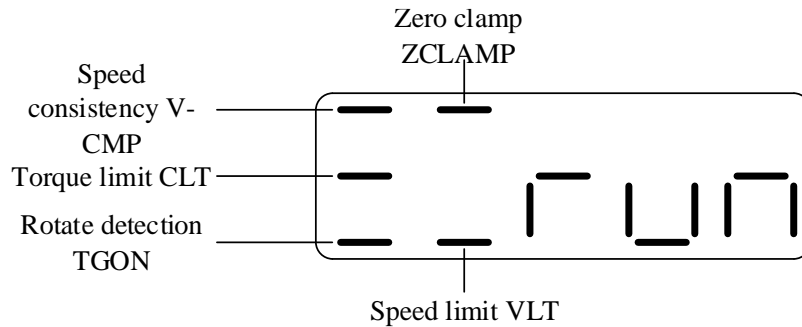

1. Digit display contents

Digit data	Display contents
P5-39 Same speed detection (/V-CMP)	When the actual speed of the motor is the same as the command speed, turn on the light. Detection Width of Same Speed Signal: P5-04 (Unit: rpm)
P5-42 Torque limit (/CLT)	When the speed is controlled, when the torque exceeds the set value, turn on the light. Internal Forward Torque Limitation: P3-28 Internal Reverse Torque Limitation of: P3-29
P5-40 Rotate detection (/TGON)	P5-03 (单位: rpm) When the motor speed is higher than the rotating speed, turn on the lamp. Rotation detection speed: P5-03 (unit: rpm)
P5-31 Zero clamp (/ZCLAMP)	When the zero clamp signal starts to operate, turn on the light.
P5-43 Speed limit (/VLT)	When the speed exceeds the set value, turn on the light when the torque is controlled. Forward speed limit in torque control: P3-16; reverse speed limit: P3-17.

2. Short code display content

Short code	Display contents
bb	Standby status Servo OFF status. (The motor is in a non-electrified state)
run	In operation Servo enabling state. (The motor is on-line)
rst	Need reset status Servo needs to be re-energized
pot	Forbidden forward drive state P-OT ON status. Refer to Section 5.2.4.
not	Forbidden reversal drive state N-OT ON status. Refer to Section 5.2.4.
idle	Control mode 2 is vacant.

■ Position control mode

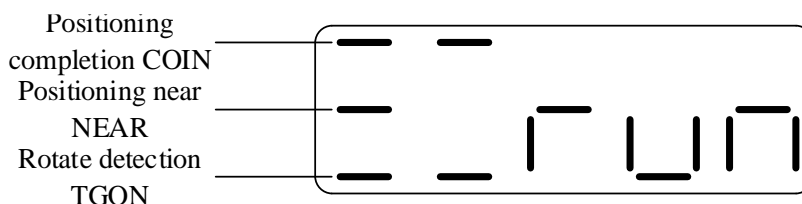

1. Digit display contents

Digit data	Display contents
P5-38 Positioning completion (/COIN)	In position control, when the given position is the same as the actual position, turn on the light. Location Completion Width: P5-00 (Unit: Instruction Pulse)
P5-36 Near (/NEAR)	In position control, when the given position is the same as the actual position, turn on the light. Near signal width: P5-06
P5-40 Rotate detection (/TGON)	When the motor speed is higher than the rotating speed, turn on the lamp. Rotation detection speed: P5-03 (unit: rpm)

2. Short code display contents

Short code	Display contents
	Standby status Servo OFF status. (The motor is in a non-electrified state)
	In operation Servo enabling state. (The motor is on-line)
	Need reset status Servo needs to be re-energized
	Forbidden forward drive state P-OT ON status. Refer to Section 5.2.4.
	Forbidden reversal drive state N-OT ON status. Refer to Section 5.2.4.
	Control mode 2 is vacant.

4.3 Group U monitor parameter

■ U0-21 input signal status

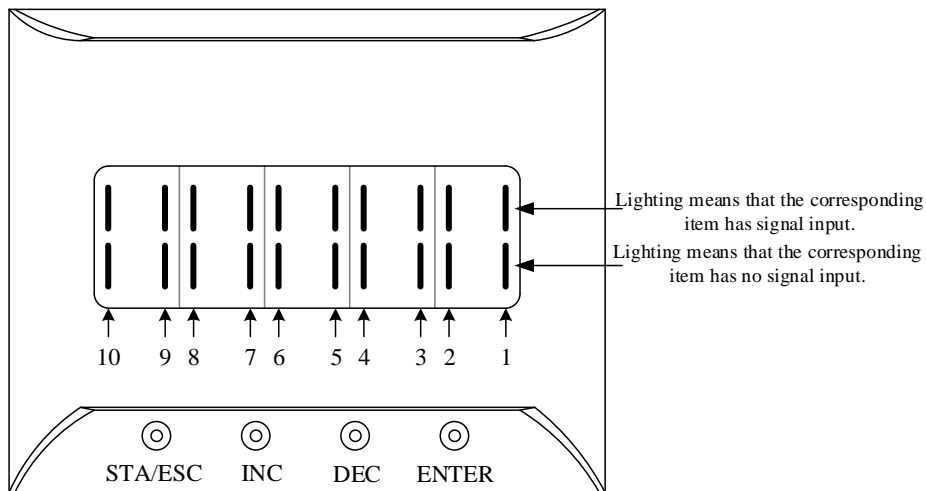

■ U0-21 input signal 1 distribution

Segment code	Description	Segment code	Description
1	/S-ON servo enable	2	/P-CON proportion action instruction
3	/P-OT prohibition of forward drive	4	/N-OT prohibition of reverse drive
5	/ALM-RST alarm reset	6	/P-CL forward side external torque limit
7	/N-CL reverse side external torque limit	8	/SPD-D internal speed selection
9	/SPD-A internal speed selection	10	/SPD-B internal speed selection

Note: When reading through communication, the binary numbers read from right to left correspond to the position of / S-ON, / P-CON, 0 means that the position signal is not input, 1 means that the position signal has input. Example: 0x0001 means / S-ON has input, 0x0201 means / S-ON and / SPD-B has input.

■ U0-22 input signal status

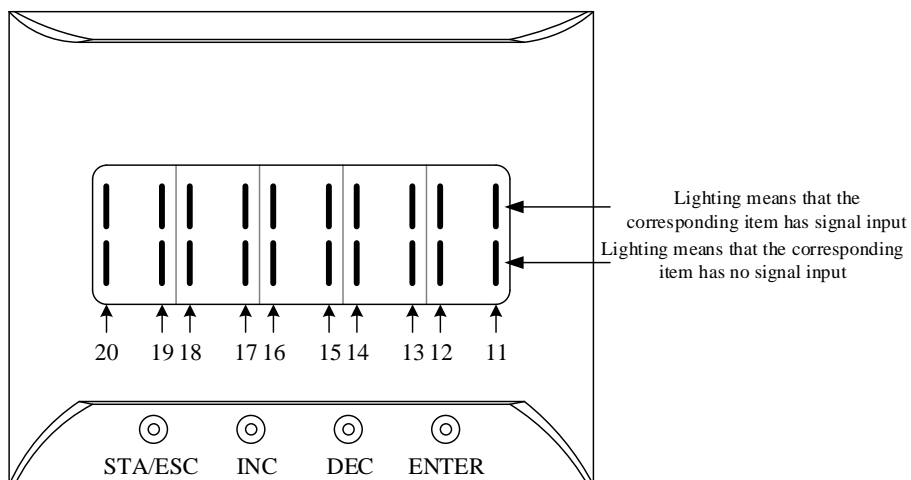

■ U0-22 input signal 2 distribution

Segment code	Description	Segment code	Description
11	/C-SEL control mode selection	12	/ZCLAMP zero clamp
13	/INHIBIT instruction pulse prohibition	14	/G-SEL gain switch
15	/CLR pulse clear	16	/CHGSTP change step
17	Reserved	18	Reserved
19	Reserved	20	Reserved

Note: When reading through communication, the binary numbers read from right to left correspond to the position of / C-SEL, / ZCLAMP, 0 means that the position signal is not input, 1 means that the position signal has input. Example: 0x0001 means / C-SEL has input, 0x0041 means / C-SEL and / G-SEL have input.

■ U0-23 output signal status

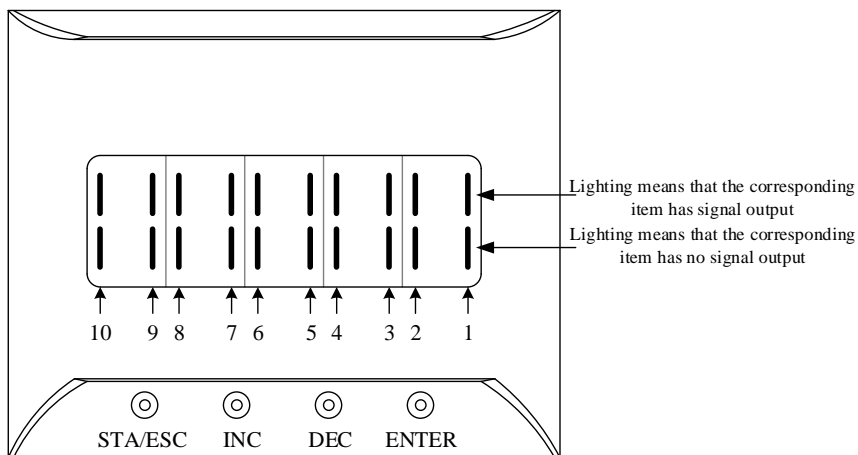

■ U0-23 output signal 1 distribution

Segment code	Description	Segment code	Description
1	Positioning completion hold (/COIN_HD)	2	Positioning completion (/COIN)
3	Same speed detection (/V-CMP)	4	Rotate detection (/TGON)
5	Ready (/S-RDY)	6	Torque limit (/CLT)
7	Speed limit detection (/VLT)	8	Break lock (/BK)
9	Warn (/WARN)	10	Output near (/NEAR)

Note: When reading through communication, the binary numbers read from right to left correspond to the position of / COIN_HD, / COIN, 0 means that the position signal is not output, 1 means that the position signal has output. Example: 0x0001 means / COIN_HD has output, 0x0201 means / COIN_HD and / NEAR has output.

■ U0-24 output signal status

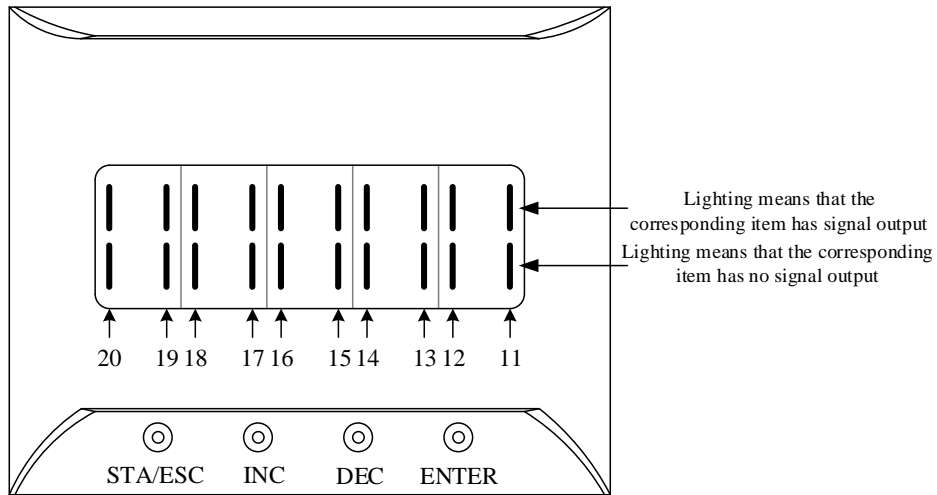

■ U0-24 output signal 2 distribution

Segment code	Description	Segment code	Description
11	Alarm (/ALM)	12	Speed arrived (/V-RDY)
13	Customized output 1	14	Customized output 2
15	/Z phase	16	/MRUN
17	Xnet bus error	18	Reserved
19	Reserved	20	Reserved

Note: When reading the state through communication, the binary numbers correspond to /ALM position in turn from right to left. 0 means that the position signal has no input, and 1 means that the position signal has input.

■ U0-88 motor code read status

U0-88 display status	Meaning
	0001—Read encoder motor parameters successfully, but P0-33=0, use the motor parameters in the read encoder.
	0011—Read the encoder motor parameters successfully, P0-33≠0, use the motor parameters in the driver.
	0021—Read the encoder motor parameters successfully, but the parameter value is 0, please set P0-53.
	0031—Read encoder motor parameters successfully, but damaged (CRC check error), please set P0-53.
	0042—Failed to read encoder motor parameters, please set P0-53.

4.4 Group F auxiliary function parameters

4.4.1 Group F0

Function code	Description	Function code	Description
F0-00	Alarm clear	F0-08	Panel external instruction auto-tuning
F0-01	Resume to default settings	F0-09	Panel internal instruction auto-tuning
F0-02	Clear the position offset	F0-10	Panel vibration suppression 1
F0-04	Clear up historical alarm records	F0-11	Panel vibration suppression 2
F0-07	Panel inertia identification	F0-12	Panel vibration suppression (fast FFT)

1. Alarm clear (F0-00)

Setting F0-00=1 can reset the alarm status. When an alarm occurs, please first eliminate the cause of the alarm, and then clear up the alarm.

2. Resume to default setting (F0-01)

Set F0-01=1 when enabler is shut down, press ENTER to resume to default settings, no need to cut power.

3. Clear the position offset (F0-02)

Set F0-02=1 to clear the offset.

4. Clear up historical alarm records (F0-04)

Set F0-04=1 can clear up historical alarm records from U1-14 to U1-53.

5. Panel inertia identification (F0-07)

Refer to panel inertia identification operation steps chapter 6.3.4.

6. Panel external instruction auto-tuning (F0-08)

Refer to external instruction auto-tuning chapter 6.5.5.

7. Panel internal instruction auto-tuning (F0-09)

Refer to internal instruction auto-tuning chapter 6.5.4.

8. Panel vibration suppression (F0-10, F0-11)

Refer to vibration suppression chapter 6.7.4.

9. Panel vibration suppression (F0-12)

Refer to vibration suppression chapter 6.7.6.

4.4.2 Group F1

Function code	Description	Function code	Description
F1-00	Jog run	F1-04	Tref (torque analog) zero-correction
F1-01	Test run	F1-05	Software enable
F1-02	Current Sampling Zero-correction	F1-06	Reset turns of absolute encoder
F1-03	Vref (speed analog) zero-correction	-	-

1. Test run (F1-01)

Before entering the test run mode, please confirm that the motor shaft is not connected to the machine!

When the servo driver is connected to the non-original encoder or power cable, it should first enter the test run mode to verify that the encoder terminal or power terminal is connected correctly.

Test run mainly checks the power cable and the encoder feedback cable to determine whether the connection is normal. According to the following operation, the motor can normally achieve forward and reverse rotation. If the motor shaft shakes or driver alarms, please immediately disconnect the power supply, and re-check the wiring situation.

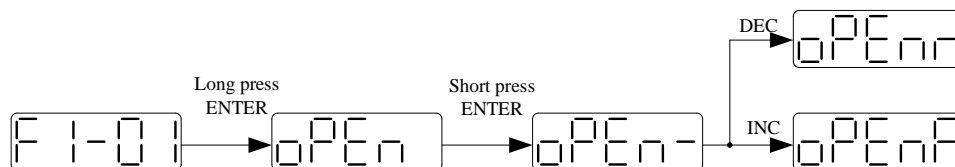

2. Jog run (F1-00)

Before entering the jog run mode, please confirm that the test run is normal when the motor is empty, so as to confirm that the servo connection is correct.

Jog run mode requires the driver to be idle in bb status!

Starting with the 3700 firmware version, the jog run function changes from position mode to speed mode. The acceleration and deceleration time is controlled by P3-09 and P3-10.

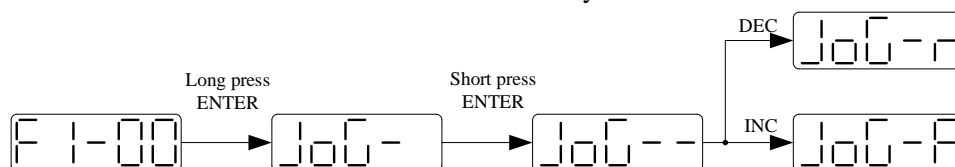

Parameter	Meaning	Default setting	Unit	Setting range	Change	Effective
P3-18	JOG speed	100	1rpm	0~1000	Servo OFF	At once

3. Current sampling zero-correction (F1-02)

When the servo driver is self-renewed or the motor runs unsteadily after a long time, the user is advised to use the current sampling zero-correction function.

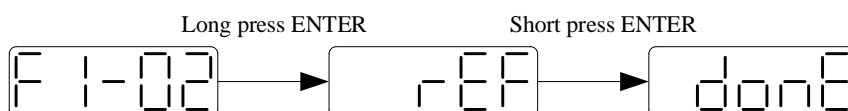

Press STATUS/ESC to exit.

4. Vref (speed analog value) zero correction (F1-03)

Refer to chapter [5.4.4.5](#).

5. Tref (torque analog value) zero correction (F1-04)

Refer to chapter [5.5.4.3](#).

6. Forced enable (F1-05)

Parameter	Signal name	Setting	Meaning	Change	Effective
P0-03	Enable mode	0	Not enable	Servo OFF	At once
		1 (default)	I/O enable /S-ON		
		2	Software enable (F1-05 or communication)		
		3	Fieldbus enable (the model which		

			supports motion bus)		
Set P0-03=2					
F1-05 = 0: cancel enable, enter bb status.					
F1-05 = 1: forced enable, servo is in RUN status.					

Note:

- (1) After power on again, the forced enable set by F1-05 will fail.
- (2) If it needs to enable when power on and still enable after re-power on, P0-03 should be set to 1 and P5-20 to n.0010.

7. Reset turns of absolute encoder (F1-06)

Refer to chapter 5.7.5.

4.5 Fault alarm handling

When a fault occurs, the alarm status is automatically jumped out, and the alarm number is displayed. When there is no fault, the alarm status is invisible. In the alarm state, the fault can be reset by writing 1 to F0-00 through panel operation.

If the servo power supply OFF makes the servo alarm, it is not necessary to clear the alarm.

Note: When an alarm occurs, the cause of the alarm should be eliminated first, and then the alarm should be removed.

4.6 Parameter setting example

An example is given to illustrate the operation steps when the content of parameter P3-09 is changed from 2000 to 3000.

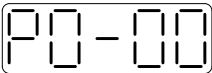
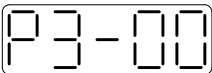
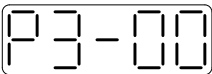
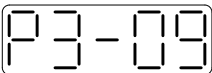
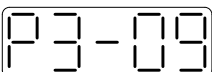
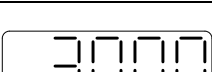
Step	Panel display	Used buttons	Operations
1		STA/ESC INC DEC ENTER ⊙ ⊙ ⊙ ⊙	No operation
2		STA/ESC INC DEC ENTER ⊙ ⊙ ⊙ ⊙	Press STA/ESC
3		STA/ESC INC DEC ENTER ⊙ ⊙ ⊙ ⊙	Press INC for three times to show P3-00
4		STA/ESC INC DEC ENTER ⊙ ⊙ ⊙ ⊙	Press ENTER, the last 0 will flash
5		STA/ESC INC DEC ENTER ⊙ ⊙ ⊙ ⊙	Press INC for 9 times
6		STA/ESC INC DEC ENTER ⊙ ⊙ ⊙ ⊙	Long press ENTER to show the value of P3-09
7		STA/ESC INC DEC ENTER ⊙ ⊙ ⊙ ⊙	Press INC, DEC, ENTER to increase decrease or shift, after changing, long press ENTER to confirm
8	END		

Note: When the setting parameter exceeds the range that can be set, the driver will not accept the setting value, and the driver will report E-021 (parameter setting exceeds the limit). The parameter setting overrange usually occurs when the upper computer writes parameters to the driver through communication.

4.7 Change motor code

A servo driver can be equipped with a variety of motors with similar power levels. Different types of motors are distinguished by the motor code on the motor nameplate. Before debugging the servo system, make sure that the motor code U3-00 matches the motor nameplate label.

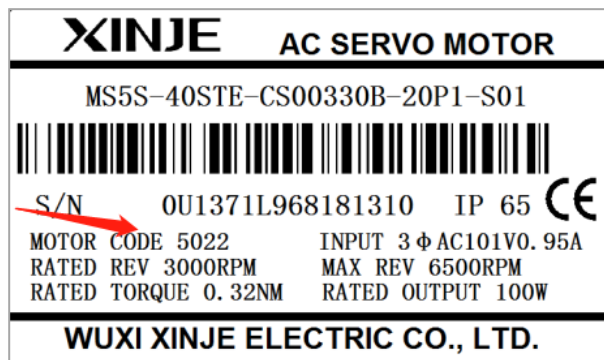
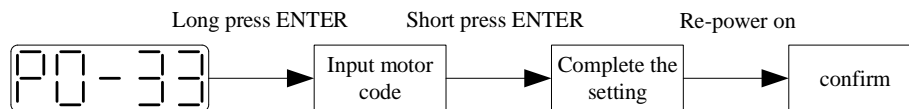

5 Operation of servo system

5.1 Control mode selection and switching

5.1.1 Control mode selection

Servo can combine two control modes and switch between them. By switching freely between mode 1 and mode 2 through the / C-SEL signal, more complex control requirements can be satisfied.

User parameter	Control mode	Reference	
P0-01 Submode 1	1	Torque control (internal setting)	5.5.1
	2	Torque control (external analog value)	5.5.4
	3	Speed control (internal setting)	5.4.2
	4	Speed control (external analog value)	5.4.4
	5	Position control (internal position instruction)	5.3.3
	6 (default)	Position control (external pulse instruction)	5.3.2
	7	Speed control (pulse frequency instruction)	5.4.3
	8	Fieldbus torque mode	5.6.4
	9	Fieldbus speed mode	5.6.5
	10	Fieldbus position mode	5.6.3
P0-02 Submode 2	1	Torque control (internal setting)	5.5.1
	3	Speed control (internal setting)	5.4.2
	5	Position control (internal position instruction)	5.3.3
	6 (default)	Position control (external pulse instruction)	5.3.2
	7	Speed control (pulse frequency instruction)	5.4.3
	8	Fieldbus torque mode	5.6.4
	9	Fieldbus speed mode	5.6.5
10	Fieldbus position mode	5.6.3	

Position control is to input the pulse train command into the servo unit and move it to the target position. The position instruction can be given by the combination of external pulse input, the total number of internal position instructions and speed limit. The position is controlled by the number of input pulses, and the speed is controlled by the frequency of input pulses. It is mainly used in the occasions requiring positioning control, such as manipulator, grinder, engraving machine, CNC machine, etc.

Speed control is to control the speed of machinery by speed command. The servo driver can control the mechanical speed quickly and accurately by the speed command given by digital, analog voltage or communication.

Torque control is to control the output torque of motor by torque command. Torque command can be given by digital, analog voltage or communication. The current of servo motor is linear with torque, so the control of current can realize the control of torque. The torque control mode is mainly used in the devices with strict requirements on the stress of materials, such as some tension control occasions such as winding and unwinding devices. The torque setting value should ensure that the stress of materials is not affected by the change of winding radius.

5.1.2 Control mode switching

Control mode switching means that when the servo is enabled, that is, when the servo panel displays run, the working mode of the servo driver can be switched between mode 1 and mode 2 through the external input signal /C-SEL.

■ Related parameter

Parameter	Name	Default setting	Suitable mode	Meaning	Change	Effective
P5-30	/C-SEL	n.0000	All	To switch the control mode	Anytime	At once

Parameter range n.0000-001A, can be distributed to other input terminal through P5-30.
 If the control mode needs to be switched through SI2 input signal, P5-30 can be set to n.0002/0012.
 Refer to section 3.2.2 for hardware wiring details.

Parameter setting	Signal/C-SEL terminal input status	Signal /C-SEL terminal logic	Control mode
P5-30=n.0000	No need external terminal input	Invalid	The control mode set by P0-01
P5-30=n.000□	SI□ terminal no signal input		
P5-30=n.001□	SI□ terminal has signal input		
P5-30=n.0010	No need external terminal input	Valid	The control mode set by P0-02
P5-30=n.000□	SI□ terminal has signal input		
P5-30=n.001□	SI□ terminal no signal input		

5.2 Basic function setting

5.2.1 Jog operation

Inching operation needs to be completed after the power supply is connected and before the online commissioning operation. Its purpose is to ensure that the servo system can operate normally without abnormal vibration, abnormal sound and other problems. Inching operation can be carried out by panel group F parameters or our upper computer debugging software xinje servo tuner.

Inching operation can be divided into two modes: inching operation and trial operation. Inching operation is closed-loop control, trial operation is open-loop control, and general steps are trial operation first, and then inching operation. Both operations can take effect only when the servo is not enabled (i.e. the panel is BB).

■ Related parameter

parameter	Meaning	Default setting	Unit	Range	Modify	Take effect
P3-18	JOG speed	100	1rpm	0~1000	Servo bb	At once

P3-18 is the speed for closed-loop inching operation, which only takes effect in two inching modes, and the rest normal control modes are invalid.

(1) jog by panel

■ Related parameter

Function code	Meaning	Explanation
F1-00	Jog operation	closed loop jog operation
F1-01	Trial operation	Open loop trial operation

The steps of jog operation through panel

Make sure the F1-01 open loop operation has no problem, then do F1-00 closed loop operation. See section 4.4.2 for the specific operation of the panel.

(2) Jog operation through XinjeServo Tuner software

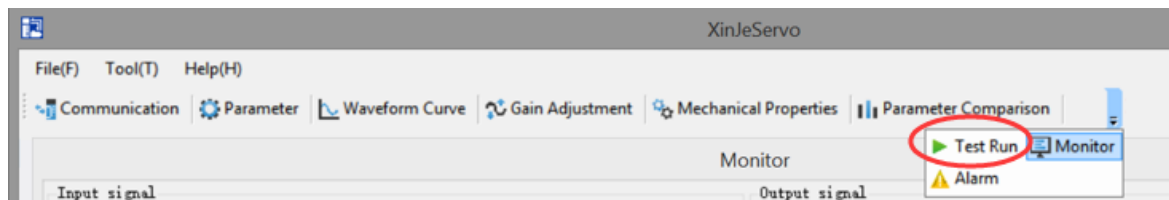

Click test run button in the menu:

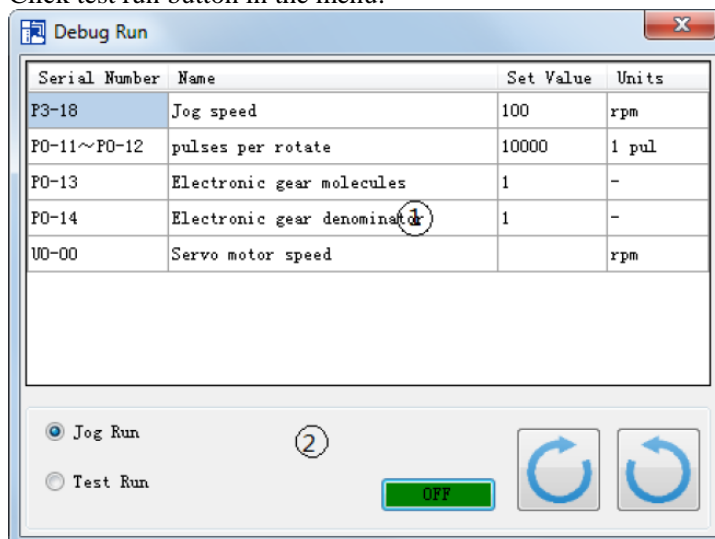

Jog speed P3-18: the motor speed in jog mode.

Jog run: closed loop inching operation.

Test run: open loop inching operation.

ON/OFF: enable the jog mode.



: forward run and reverse run.

The steps of inching through Xinje servo tuner

Open the software XinjeServo Tuner, set the jog speed P3-18, select test run/jog run button, click ON. Then click forward or reverse button to run.

5.2.2 Servo enable setting

The servo enable signal effectively represents that the servo motor is powered on. When the servo enable signal is invalid, the motor cannot operate without power. The enabling mode can be controlled by external terminal signal or upper computer communication.

■ Related parameter

parameter	Name	Setting	Meaning	Change	Effective
P0-03	Enable mode	0	Not enable	Servo bb	At once
		1(default)	I/O enable /S-ON		
		2	Software enable (F1-05 or enabled by software)		
		3	Fieldbus enable		

parameter	Name	Default setting	Suitable mode	Meaning	Modify	Effective
P5-20	/S-ON	n.0001	All	servo enable signal	Anytime	At once

(1) Forced enabling

When P0-03=2, the forced enabling of F1-05 can take effect, and the forced enabling fails after power on again.

F1-05 can write 1 to hex address 0x2105 through ModbusRTU protocol communication or set to 1 through the panel.

(2) Power on enable

Parameter setting P0-03 = 1 (default), P5-20 = n.0010

This setting mode can make the servo system in the enabling state as soon as it is powered on, without external terminal control, and the servo enabling state will remain when it is powered on again.

(3) External SI terminal control enable

When P0-03 is set to 1, the external terminal enable control is effective.

Parameter setting P0-03 = 1 (default), P5-20 = n.000□/n.001□.

□ is the SI terminal number, for example, P5-20 is n.0001 (default), that is, SI1 terminal control enable.

Prerequisite	Parameter setting status	signal/S-ON terminal input status	signal/S-ON terminal logic	Servo status
P0-03=1	P5-20=n.000□	SI□ terminal has no sigal input	invalid	The panel displays BB, and the servo is not enabled
	P5-20=n.001□	SI□ terminal has sigal input		
	P5-20=n.000□	SI□ terminal has sigal input	valid	The panel shows run, servo enabled
	P5-20=n.001□	SI□ terminal has no sigal input		

(4) Bus enable

When P0-03 is 3, it is applicable to the Xnet bus upper computer enable (applicable to DS5E Series). Xnet bus is a proprietary bus of Xinje. The servo system needs to work with the PLC supporting xnet bus. For specific operation, please refer to the user manual of x-net.

5.2.3 Rotation direction switching

■ Related parameter

Parameter	Meaning	Default setting	Unit	Range	Modify	Effective
P0-05	Definition of rotation direction 0- positive mode 1- negative mode	0	-	0~1	Servo bb	Power on again

The user can change the rotation direction of servo motor through parameter P0-05. It is specified that the "forward rotation" of the motor is "counter clockwise rotation" and "reverse rotation" is "clockwise rotation". (all view from the motor axis)

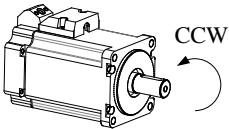
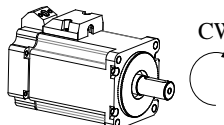
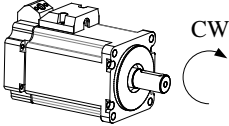
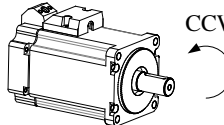
Mode	Forward running	Reverse running	P0-05 setting
Standard setting CCW is forward run			P0-05=0
Reverse mode CW is forward run			P0-05=1

5.2.4 Stop mode

Servo shutdown can be divided into inertia shutdown and deceleration shutdown according to the shutdown mode. The following explains the servo shutdown mode.

Shutdown mode	Inertia stop	Deceleration stop
Stopping principle	The servo driver is not enabled, the servo motor is not powered, and free deceleration to 0. The deceleration time is affected by mechanical inertia, equipment friction, etc.	The servo driver outputs the reverse braking torque, and the motor decelerates rapidly to 0.
Stopping features	Advantages: smooth deceleration, small mechanical impact, small mechanical impact Disadvantage: slow deceleration process	Advantages: short deceleration time Disadvantages: mechanical impact

According to different scenarios of servo shutdown, it can be divided into servo off shutdown, alarm shutdown and over travel shutdown.

(1) Servo OFF and alarm shutdown

■ Related parameter

Parameter	Meaning	Default setting	Unit	Range	Modify	Effective
P0-30	Stop timeout	20000	1ms	0~65535	Servo bb	At once
P3-32	braking torque	300	1%	0~1000	Anytime	At once
P5-03	Rotation detection speed	50	rpm	0~10000	Anytime	At once
P0-27	Servo OFF stop mode	0	-	0/2	Servo bb	At once
P0-29	Alarm stop mode	2	-	0/2	Servo bb	At once

Parameter	Value	Meaning
P0-27/ P0-29	0	inertia stop and maintain the inertia operation state after stopping.
	2	deceleration brake stop and maintain the inertia operation state

		after stopping.
--	--	-----------------

Note:

- (1) P0-27 / P0-29 = 0, inertia stops, and maintains inertia operation state after stopping. When the servo is off and the alarm occurs, the motor starts to stop by inertia until the speed is less than P5-03, and then it turns to free stop. The servo will time the inertia stop process. In the process of inertia stop, if the timing time has been greater than P0-30, and the motor speed has not dropped below P5-03, the servo will directly free stop, and give the stop timeout alarm E-262.
- (2) P0-27 / P0-29 = 2, deceleration braking stops, and maintains inertia operation state after stopping. When servo off and alarm occur, the motor will generate a braking torque of P3-32. The motor will start braking and stop until the speed is less than P5-03 (rotation detection speed), and then it will turn to free stop. At the same time, the servo will timing the braking stop process. In the process of inertia stop, if the timing time has been greater than P0-30, and the motor speed has not dropped below P5-03, the servo will directly free stop, and give the stop timeout alarm E-262.
- (3) The so terminal of servo driver is equipped with holding brake function. No matter P0-27 / P0-29 = 0 or 2, it stops in deceleration mode.

(2) Stop mode in case of over travel

The overtravel prevention function of servo unit refers to the safety function that the servo motor is forced to stop by inputting the signal of limit switch when the movable part of the machine exceeds the designed safe moving range.

■ Related parameter

parameter	Meaning	Default setting	Unit	Setting range	Modify	Effective
P0-28	Servo override stop mode	2	-	0~3	Servo bb	At once
P0-30	Stop timeout	20000	1ms	0~65535	Servo bb	At once
P3-32	Braking torque	300	1%	0~1000	Anytime	At once
P5-22	Forward run prohibition /P-OT	n.0003	-		Anytime	At once
P5-23	Reverse run prohibition /N-OT	n.0000	-		Anytime	At once

Be sure to connect the limit switch as shown in the figure below.

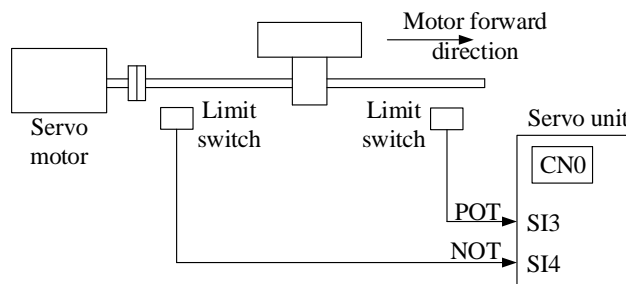

Rotary applications such as round tables and conveyors do not need the function of overrun prevention. At this time, there is no need to connect the overrun prevention with input signals.

Parameter setting	Signal /POT, terminal input status	Overtravel signal (/POT, /NOT) terminal logic
P5-22/P5-23=n.0000	No need to connect external input	invalid
P5-22/P5-23=n.000□	SI□ terminal has no signal input	
P5-22/P5-23=n.001□	SI□ terminal has signal input	
P5-22/P5-23=n.0010	No need to connect external input	valid
P5-22/P5-23=n.000□	SI□ terminal has signal input	

P5-22/P5-23=n.001□	SI□ terminal has no signal input	
--------------------	----------------------------------	--

Parameter settings in forward limit signal /POT and reverse limit signal /NOT can not be set to the same terminal input at the same time.

Direction	Meet the limit	Operation status
Forward run	positive limit is valid	POT, set the servo overrun stop mode as P0-28
	negative limit is valid	Alarm E-261
Reverse run	positive limit is valid	Alarm E-261
	negative limit is valid	NOT, set the servo overrun stop mode as P0-28

Parameter	Value	Meaning
P0-28 n.xxx□	0	The deceleration stops 1, the overrun direction moment is 0 after stopping, and receiving instructions.
	1	Inertia stops, after stopping, overrun direction moment is 0, receiving instructions.
	2	The deceleration stops 2, after stopping, the overrun direction does not receive instructions.
	3	Alarm (E-260)
P0-28 n.xx□x	0	Unshielded over travel alarm E-261
	1	Shielded over travel alarm E-261

Note:

(1) When P0-28 = 0/2, the motor starts to decelerate and stop after receiving the overtravel stop signal, and the braking torque is P3-32 when decelerating stop, and the stop timeout also plays a role in the overtravel process.

(2) During position control, when the motor is stopped by over travel signal, there may be position deviation pulse. To clear the position deviation pulse, the clear signal /CLR must be input. If the servo unit still receives pulses, they will accumulate until the servo unit gives an alarm.

(3) During torque control, the SO terminal of servo drive has the function of holding brake, which can't be distributed through the overtravel signal terminals P5-22 and P5-23.

(4) Servo driver SO terminal is assigned with holding brake function, P0-28 is automatically set to 2.

5.2.5 Power-off brake

When the servo motor controls the vertical load, the purpose of using the "brake servo motor" is: when the power supply of the system is placed in the "OFF", the movable part will not move under the action of gravity.

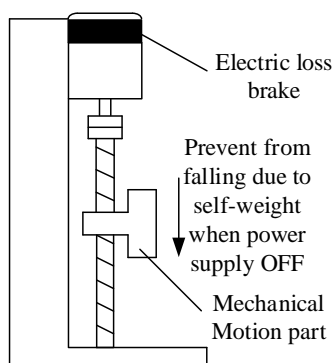

Note: The brake built in the servo motor is a fixed special brake without excitation. It can not be used for dynamic braking. Please use it only when the servo motor is in a stop state.

■ Related parameter

Parameter	Meaning	Default setting	Unit	Setting range	Modify	Effective
P5-44	Brake interlock/BK	n.0000	-	n.0000~n.0018	Anytime	At once
P5-07	Servo OFF delay time	500	1ms	0~65535	Servo bb	At once
				-500~9999 (after version 3760)		
P5-08	Brake command output speed	30	rpm	20~10000	Servo bb	At once
P5-09	Brake command wait time	500	ms	0~65535	Servo bb	At once

(1) Hardware wiring

The ON/OFF circuit of the brake is composed of the sequential output signal of the servo unit "/BK" and "brake power supply". A typical connection example is shown below.

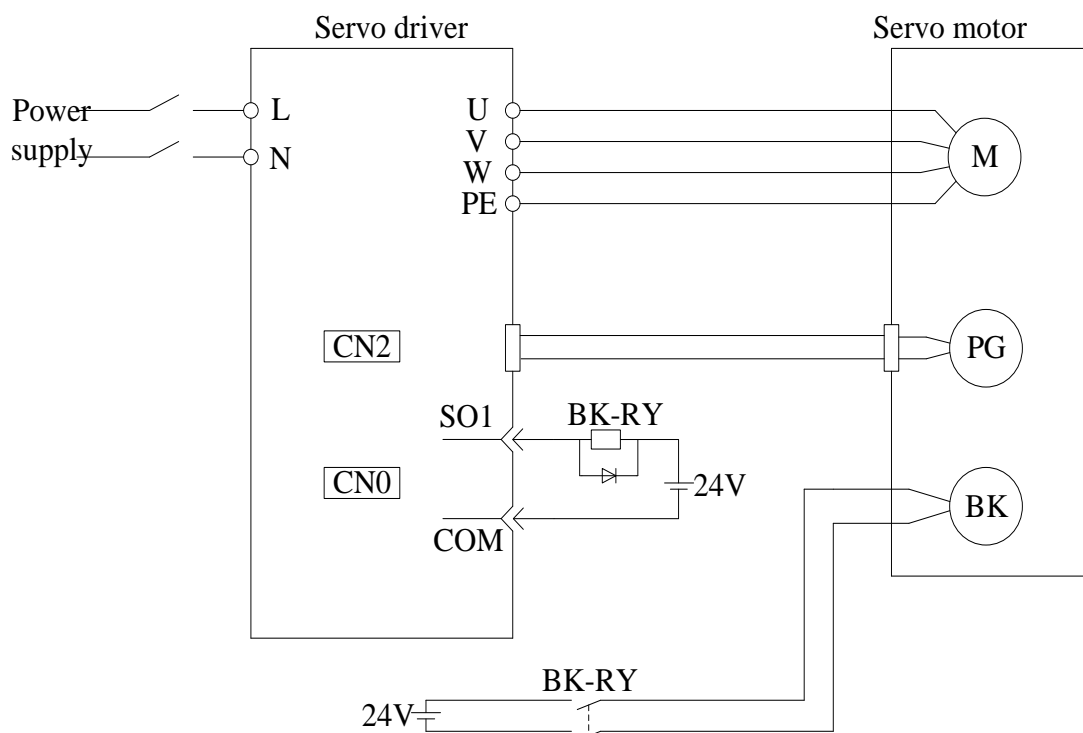

Note:

- (1) The excitation voltage of the power-off brake is 24V.
- (2) If the holding brake current is more than 50mA, please transfer it through the relay to prevent terminal burnt out due to excessive current.

(2) Software parameter settings

For the servo motor with holding brake, it is necessary to configure one SO terminal of servo driver as holding brake output /BK function, and determine the effective logic of SO terminal, that is, parameter P5-44 needs to be set.

Parameter setting	Servo status	Signal/BK terminal output logic	Servo motor status
P5-44=n.000□	Servo bb	Invalid	Holding brake power off, motor in position locked state
	Servo run	Valid	The holding brake power is connected and the motor is in rotatable state
P5-44=n.001□	Servo run	Invalid	Holding brake power off, motor in position locked state
	Servo bb	Valid	The holding brake power is connected and the motor is in rotatable state

Note:

- (1) When SO terminal is used to control holding brake, when servo enable is on, holding brake power is on and motor is in rotatable state;
- (2) If the motor fails to rotate during the debugging of the new machine, please confirm whether the holding brake is open.

(3) Time sequence of holding brake control

① Holding brake sequence in normal state

Due to the action delay time of the brake, the machine moves slightly under the action of gravity. Use P5-07 parameter to adjust the time, so that the holding brake can be opened or closed in advance.

When setting the servo motor with brake, the output signal "/BK" of control brake and the time of servo SON signal on/off action are shown in the figure below. That is to say, before the /BK signal outputting and brake is opened, the servo motor has entered the power on enabling state; after the /BK not outputting and brake is locked, the servo motor will turn off the power on state.

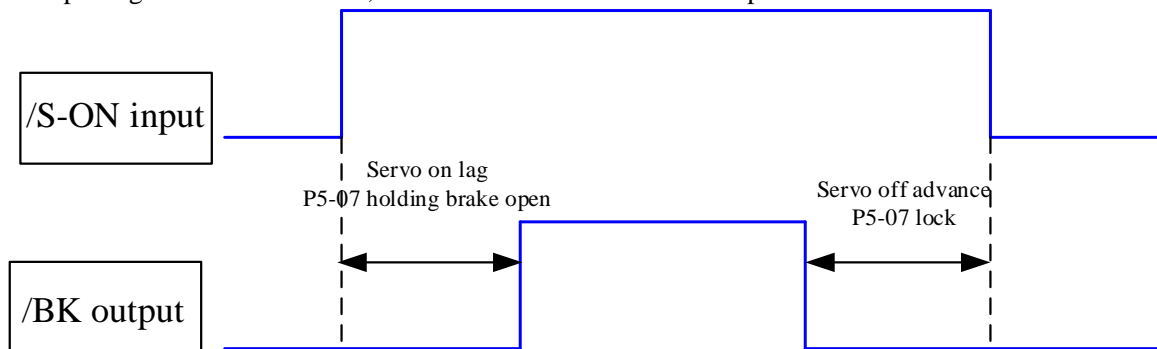

Note: the setting made here is the time when TGON of rotation detection is invalid when the motor is stopped.

② Abnormal state holding brake timing

When the alarm/power supply interruption occurs, the motor quickly becomes non energized. During the time from gravity or inertia to the brake action, the machine will move. To avoid this,

The conditions for the /BK signal to turn from on to off in the motor rotation are as follows (any of the two conditions will take effect):

- 1) After the servo is off, the motor speed is below the set value of P5-08;
- 2) After the servo is off, when the set time of P5-09 is exceeded.

The sequence diagram is as follows:

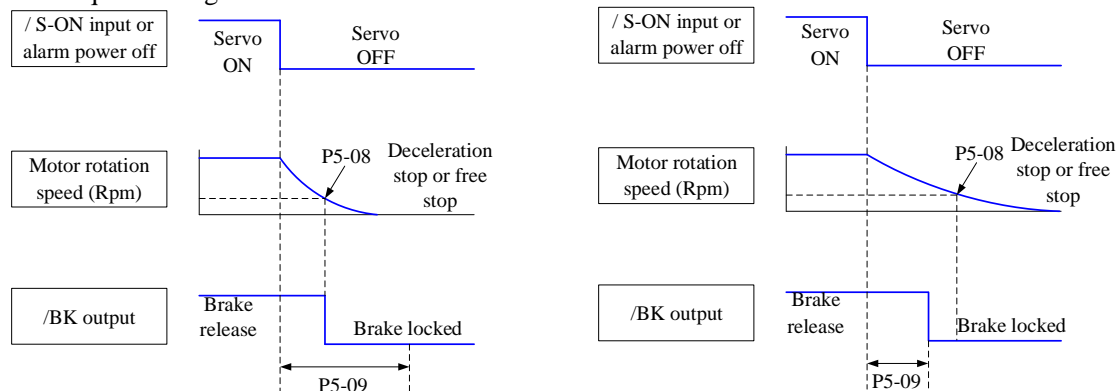

Since the brake of the servo motor is designed for position holding, it must be enabled at the right time when the motor stops. While observing the action of the machine, adjust the user parameters.

5.2.6 Braking setting

When the servo motor is driven by the generator mode, the power returns to the servo amplifier side, which is called regenerative power. Regenerative power is absorbed by charging the smoothing capacitor in the servo amplifier. After exceeding the rechargeable energy, the regenerative resistance is used to consume the regenerative power.

The servo motor is driven by regeneration (generator) mode as follows:

- Deceleration stop period during acceleration and deceleration operation;
- When the vertical axis is running downward;
- When the external load drives the motor to rotate.

■ Related parameter

Parameter	Meaning	Default setting	Unit	Setting range	Modify	Effective
P0-24	Discharge resistance type selection (version 3640 and before) 0: built-in 1: external Power protection mode of discharge resistance (version 3700 and later) 0 - cumulative discharge time 1 - average power mode 1 2 - average power mode 2	0	-	0~1	Servo bb	At once
P0-25	Power value of discharge resistance	Set as model	W	1~65535	Servo bb	At once
P0-26	Discharge resistance value	Set as model	Ω	1~500	Servo bb	At once

1. Hardware wiring

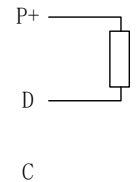
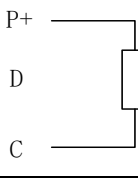
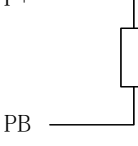
Power	Hardware terminal	Notes	
Below 5.5KW	P+, D	Built-in resistor	
	P+, C	External resistor	
5.5KW and above	P+, PB	External resistor	

2. Recommended brake resistance specifications

Servo driver model	min resistance (cannot be less than this value)	External regeneration resistance (recommended resistance)	External regeneration resistance (recommended power value)
DS5F-20P1-PTA	50Ω	50Ω-100Ω	Above 200W
DS5F-20P2-PTA			
DS5F-20P4-PTA	40Ω	40Ω-100Ω	Above 500W
DS5F-20P7-PTA			
DS5F-21P5-PTA	25Ω	25Ω-50Ω	Above 1000W
DS5F-22P3-PTA			
DS5F-22P6-PTA			
DS5F-43P0-PTA	55Ω	55Ω - 75Ω	Above 1000W
DS5F-45P5-PTA	25Ω	25Ω - 65Ω	Above 2000W
DS5F-47P5-PTA	25Ω	25Ω - 50Ω	Above 2000W

Note:

(1) The smaller the resistance is, the faster the discharge will be, but it is easy to break down the resistance if it is too small. Therefore, the lower limit should be as close as possible but not less than the lower limit when selecting the type.

(2) When wiring, please use high temperature resistant and flame-retardant wires, and pay attention that the regenerative resistance surface does not contact with the wires.

5.3 Position control

5.3.1 General position control

5.3.1.1 Electronic gear ratio

1. Overview

The so-called "electronic gear" function has two main applications:

(1) Determine the number of command pulses needed to rotate the motor for one revolution to ensure that the motor speed can reach the required speed.

As an example of 17-bit encoder motor, the pulse frequency sent by the upper computer PLC is 200kHz:

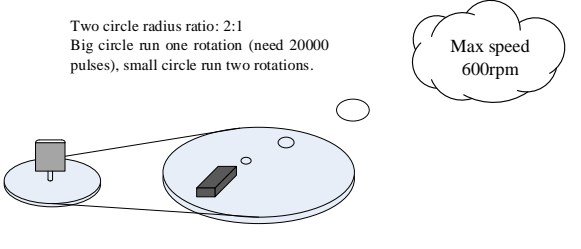
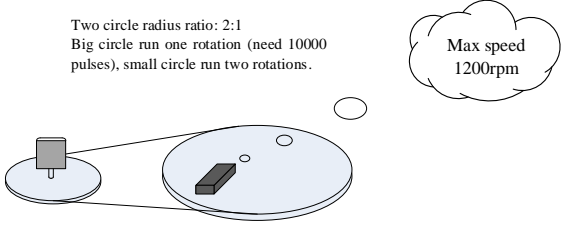
Pulses per revolution set to 10000 Electronic gear ratio set to 131072:10000	Set pulses per revolution to 5000 Electronic gear ratio set to 131072:5000
<p>Two circle radius ratio: 2:1 Big circle run one rotation (need 20000 pulses), small circle run two rotations.</p> 	<p>Two circle radius ratio: 2:1 Big circle run one rotation (need 10000 pulses), small circle run two rotations.</p> 

(2) In the precise positioning, the physical unit length corresponding to 1 command pulse is set for calculation.

For example: the object moves 1um per command pulse. The command pulses of load rotating one circle = 6mm / 1um = 6000. In the case of deceleration ratio is 1:1, set pulse per rotation P0-11=6000, P0-12=0. Then if the PLC outputs 6000 pulses, the object will move 6mm.

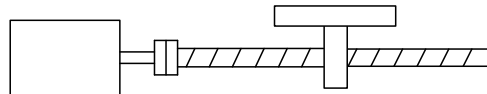

Encoder: 131072 (17-bit) ball screw pitch: 6mm

Do not change the electronic gear ratio	Change the electronic gear ratio
<p>Without changing the ratio of the electronic gear to the motor, the rotating cycle is 131072 pulses (P 0-11=0, P 0-12=0). If the workpiece is moved 6 mm in one turn, the number of pulses needed is 131072. If the workpiece is moved 10 mm, it will need $10/6 * 131072 = 218453.333$ pulses. When the decimal number is omitted, the error will occur.</p>	<p>By changing the electronic gear ratio, the motor needs 6000 pulses to rotate one circle. If the workpiece moves 6 mm in one turn, the number of pulses needed is 6 000. If the workpiece is moved 10 mm, it needs $10/6 * 6000 = 10000$ pulses. When the pulse is sent, the decimal number will not be produced and the error will not be produced.</p>

■ Related parameters

Parameter	Meaning	Default setting	Unit	Setting range	Modify	Effective
P0-11	Pulse numbers per rotation *1	0	pul	0~9999	Servo OFF	At once
P0-12	Pulse numbers per rotation *10000	1	pul	0~9999	Servo OFF	At once
P0-13	Electronic gear ratio (numerator)	1	-	0~65535	Servo OFF	At once
P0-14	Electronic gear ratio (denominator)	1	-	0~65535	Servo OFF	At once
P0-92	Group 2 Electronic gear ratio (numerator) low bit*1	1	-	1~9999	Servo OFF	At once

P0-93	Group 2 Electronic gear ratio (numerator) high bit*10000	0	-	1~65535	Servo OFF	At once
P0-94	Group 2 Electronic gear ratio (denominator) low bit*1	1	-	1~9999	Servo OFF	At once
P0-95	Group 2 Electronic gear ratio (denominator) high bit*10000	0	-	1~65535	Servo OFF	At once

Note:

- (1) P0-11~P0-14 is all about the parameters of electronic gear ratio, P0-11, P0-12 is group 1, P0-13, P0-14 is group 2, but the priority of P0-11 and P0-12 is higher than that of P0-13 and P0-14. Only when P0-11 and P0-12 are set to 0, the ratio of electronic gear P0-13 and P0-14 will take effect.
- (2) When P0-11, P0-12, P0-13 and P0-14 are all set to 0, P0-92, P0-93, P0-94 and P0-95 will take effect.

2. Calculation of Pulse Number per Rotation and Electronic Gear Ratio

Steps	Content	Description	
1	Confirm the machine specification	Confirm the deceleration ratio n:m(servo motor turns m rotations while load turns n rotations), ball screw distance, pulley diameter.	
2	Confirm the encoder pulse	Confirm the servo motor encoder accuracy	
3	Set the command unit	Determine the actual distance or angle corresponding to 1 pulse of the controller	
4	Calculate the command pulses the load shaft rotates 1 circle	Based on the determined command unit, calculate the command quantity n of the load shaft rotating for 1 revolution.	
5	Calculate the pulses per rotation M	Command pulse number of motor shaft rotating for 1 turn $M=N/(m/n)$.	
6	Set the pulses per rotation (P0-11/P0-12) or Electronic gear ratio (P0-13/P0-14)/(P0-92~95)	P0-11=M%10000 P0-12=M/10000	priority ↓
		$\frac{P0-13}{P0-14} = \frac{\text{resolution}}{M} = \frac{\text{resolution} \times m}{N \times n}$	

Note:

(1) In step 6, the effective priority of the number of pulses per revolution is higher than the electronic gear ratio, that is, when P0-11 ~ P0-12 are all 0, P0-13 ~ P0-14 will take effect. In special cases, if the number of pulses per revolution is calculated as a decimal, the electronic gear ratio should be considered.

(2) When P0-13 and P0-14 exceed the setting range, please divide the electronic gear ratio into numerator and denominator. If the ratio still exceeds the parameter setting range, please use the second gear ratio P0-92~P0-95. Only when P0-11~14 = 0, the second gear ratio takes effect.

(3) The resolution of DS5 series servo motor encoder is 131072 (17 bits) and 8388608 (23 bits).

(4) The command unit does not represent the machining accuracy. On the basis of the mechanical accuracy, refining the instruction unit quantity can improve the positioning accuracy of the servo system. For example, when using the lead screw, the mechanical accuracy can reach 0.01mm, so the unit equivalent of 0.01mm is more accurate than the unit equivalent of 0.1mm.

3. Example of setting the electronic gear ratio

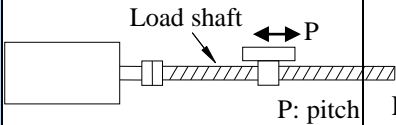
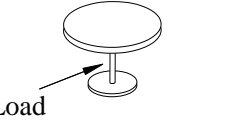
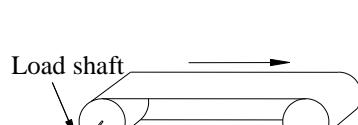
steps	Name	Ball screw	Round table	Belt + pulley
		 $1 \text{ rotate} = \frac{P}{\text{command unit}}$	 $1 \text{ rotate} = \frac{360^\circ}{\text{command unit}}$	 $1 \text{ rotate} = \frac{\pi D}{\text{command unit}}$
1	Confirm mechanical specifications	Ball screw pitch: 6mm Machine deceleration ratio: 1:1	1-circle rotate angle: 360° Deceleration ratio: 1:3	Pulley diameter: 100mm Deceleration ratio: 1:2
2	Confirm the	Encoder resolution 131072	Encoder resolution	Encoder resolution 131072

	number of encoder pulses		131072	
3	Confirm the command unit	1 command unit: 0.001mm	1 command unit: 0.1 °	1 command unit: 0.02mm
4	Calculate the command amount of 1 revolution of load shaft	6mm/0.001mm=6000	360/0.1=3600	314mm/0.02mm=15700
5	Calculate the pulse number of one revolution of motor shaft	M =6000/(1/1)=6000	M=3600/(3/1)=1200	M=15700/(2/1)=7850
6	Set pulses per rotation P0-11/P0-12	P0-11=6000 P0-12=0	P0-11=1200 P0-12=0	P0-11=7850 P0-12=0
	Set electronic gear ratio (P0-13/P0-14)/ (P0-92~95)	P0-13=131072 P0-14=6000 After reduction P0-13=8192 P0-14=375	P0-13=131072 P0-14=1200 After reduction P0-13=8192 P0-14=75	P0-13=131072 P0-14=7850 After reduction P0-13=65536 P0-14=3925 Conver to second gear ratio P0-92=5536 P0-93=6 P0-94=3925 P0-95=0

5.3.1.2 Positioning completion signal (/COIN, /COIN_HD)

In position control, the signal indicating the completion of servo motor positioning is used when the command controller needs to complete positioning confirmation.

■ Related parameters

Parameter	Meaning	Default setting	Unit	Range	Change	Effective
P5-00	Positioning completion width	11	Command unit	0~65535	Anytime	At once
P5-01	Positioning completion detection mode	0	-	0~3	Anytime	At once
P5-02	Positioning completion hold time	0	ms	0~65535	Anytime	At once

Parameter	Signal name	Default setting	Suitable mode	Meaning	Modify	Effective
P5-37	/COIN-HD	n.0000	All	Positioning complete holding	Anytime	At once
P5-38	/COIN	n.0000	All	Positioning complete output	Anytime	At once

Refer to section 3.2.2 for hardware wiring details.

If it is necessary to output signal from SO2, P5-37 and P5-38 are set to n.0002/0012. Note that an SO terminal can only be used as a signal function.

1. Conditions for positioning completion signal output

(1) /COIN-HD signal output conditions

When the positioning completion detection mode P5-01 is set to 3, the positioning completion holding /COIN-HD signal can be output. When the /COIN signal holds P5-02 time, the COIN-HD signal can be output.

(2) /COIN signal output conditions

According to the positioning completion detection mode set in P5-01, output positioning

completion /COIN signal. The following is the precondition for positioning output and the output diagram.

P5-01 setting	Content	Diagram
0	If the absolute deviation is below P5-00, the COIN signal will be output.	
1	After the instruction is finished, the deviation is below P5-00 and COIN signal is output.	
2	When the instruction ends and the motor speed is under the rotation detection speed (P5-03) and the absolute deviation is less than P5-00, the COIN signal is output.	
3	At the end of instruction, the absolute deviation value under P5-00, it outputs COIN signal. If COIN maintains P5-02 time, COIN-HOLD signal is output.	

2. Description of positioning completion width

(1) The positioning completion width P5-00 changes proportionally due to the change of electronic gear ratio, and the factory default is 11 command units.

The following table is an example:

Number of command pulses required for one revolution of motor	positioning completion width P5-00
10000 (default)	11 (default)
20000	22
5000	6
3000	4
2000	3

The positioning completion width P5-00 changes proportionally with the number of command pulses required for one revolution of the motor.

The output of the positioning completion signal depends on the positioning completion width. The smaller the width is, the later the positioning completion signal output is, but the signal output does not affect the actual operation state of the motor.

(2) The positioning completion width can also be set separately, and its change will not affect the number of command pulses required for one revolution of the motor.

5.3.1.3 Positioning near signal (/NEAR)

The servo motor is located near the positioning completion signal, so that the equipment can prepare the next action in advance.

■ Related parameters

Parameter	Meaning	Default setting	Unit	Range	Change	Effective
P5-06	Near signal output width	50	Command unit	0~65535	Anytime	At once

Parameter	Signal name	Default setting	Suitable mode	Meaning	Modify	Effective
P5-46	/NEAR	n.0000	All	Positioning near	Anytime	At once

Refer to section 3.2.2 for hardware wiring details.

If it is necessary to output from the SO2, P5-46 can be set to n.0002/0012.

1. Positioning approach signal output conditions

When the pulse deviation value U0-08 of the servo driver is lower than the P5-06 setting value, the positioning approach signal (/NEAR) is output.

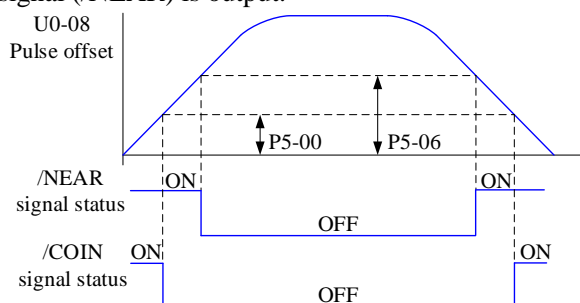

2. Description of approach signal output

(1) The approach signal output width P5-06 changes proportionally due to the change of the electronic gear ratio. The default setting is 11 command units.

The following table is an example:

Number of command pulses required for one revolution of motor	Near signal output width P5-06
10000 (default)	50 (default)
20000	100
5000	25
3000	15
2000	10

The near signal output width P5-06 changes proportionally with the number of command pulses required for one revolution of the motor.

The output of the positioning completion signal depends on the positioning completion width. The smaller the width is, the later the positioning completion signal output is, but the signal output does not affect the actual operation state of the motor.

(2) The approach signal output width can also be set independently, and its change will not affect the number of command pulses required for one revolution of the motor.

(3) Please set this parameter larger than the positioning completion width.

5.3.1.4 Command pulse prohibition (/INHIBIT)

Position command prohibition, including internal and external position commands. Stop the function of command pulse input during position control. When the /INHIBIT signal is on, the pulse command is no longer counted.

■ Related parameters

Parameter	Signal name	Default setting	Suitable mode	Meaning	Modify	Effective
P5-32	/INHIBIT	n.0000	All	Command pulse prohibition	Anytime	At once

Parameter range n.0000-001A, assigned to other input terminals by parameter P5-32.
If it is necessary to input from SI2, P5-32 can be set to n.0002/0012. Refer to section 3.2.2 for hardware wiring details.

1. /INHIBIT terminal effectiveness description

Parameter setting status	Signal/INHIBIT terminal input status	Signal/INHIBIT terminal logic
P5-32=n.0000	No external terminal input	Invalid
P5-32=n.000□	SI□ terminal has no signal input	
P5-32=n.001□	SI□ terminal has signal input	
P5-32=n.0010	No external terminal input	Valid
P5-32=n.000□	SI□ terminal has signal input	
P5-32=n.001□	SI□ terminal has no signal input	

2. The influence of /INHIBIT terminal signal on the running state of motor

Control mode	Motor operation status	
	/INHIBIT terminal logic valid	/INHIBIT terminal logic invalid
5- internal position control	Pause current segment	/INHIBIT signal is from ON→OFF, continue running from pause point.
6- external pulse position control	Pause pulse command reception	/INHIBIT signal is from ON→OFF, continue running from the pulse command received after OFF.

5.3.1.5 Offset clear (/CLR)

Position offset=(position command – position feedback)(encoder unit)

The position deviation clearing function means that the driver can clear the position deviation when the servo is off or the /CLR signal is received.

■ Related parameters

Parameter	Signal name	Default setting	Suitable mode	Meaning	Modify	Effective
P5-34	/CLR	n.0000	All	Pulse deviation clear	Anytime	At once

Parameter range n.0000-001A, assigned to other input terminals by parameter P5-34.
If it is necessary to input signal from SI2, P5-34 can be set to n.0002/0012. Refer to section 3.2.2 for hardware wiring details.

1. /CLR signal effectiveness

parameter setting status	Signal /CLR terminal input status	Signal /CLR terminal logic
P5-34=n.0000	No external terminal input	Invalid
P5-34=n.000□	SI□ terminal has no signal input	
P5-34=n.001□	SI□ terminal has signal input	
P5-34=n.0010	No external terminal input	Valid
P5-34=n.000□	SI□ terminal has signal input	
P5-34=n.001□	SI□ terminal has no signal input	

2. /CLR signal explanation

Send the pulse to the servo, execute the /CLR input signal, the servo will lock the current pulse counts, then update the current position of the encoder to the position feedback in the control, at the

same time, clear the intermediate quantity of the position loop, speed loop and current loop.
/CLR signal is triggered by edge.

3. Other description of pulse position deviation clearing signal

Setting F0-02 to 1 can also clear the pulse position deviation.

5.3.1.6 Position pulse deviation

Pulse deviation value refers to the difference between command pulse of command controller (such as PLC) and feedback pulse of servo unit in position mode. Its unit is 1 command unit, which is related to the command unit determined by electronic gear ratio.

In position control, when the deviation pulse exceeds a certain limit value, an alarm will occur, and this threshold value is the deviation pulse limit value.

■ Related parameters

parameter	Meaning	Default setting	Unit	Range	Change	Effective
P0-23	pulse deviation limit value	2000	0.01 turns	0~65535	Anytime	At once

When the deviation pulse limit is 0, the deviation pulse will not be detected.

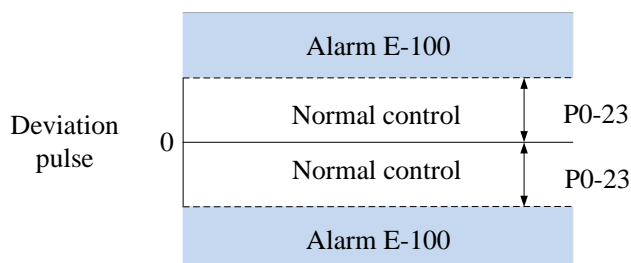

5.3.1.7 Position command filter

■ Related parameters

Parameter	Meaning	Default setting	Unit	Range	Change	Effective
P1-24	Position command acceleration and deceleration filtering time	0	0.1ms	0~65535	Servo OFF	At once
P1-25	Position command smoothing filtering time	0	0.1ms	0~65535	Servo OFF	At once

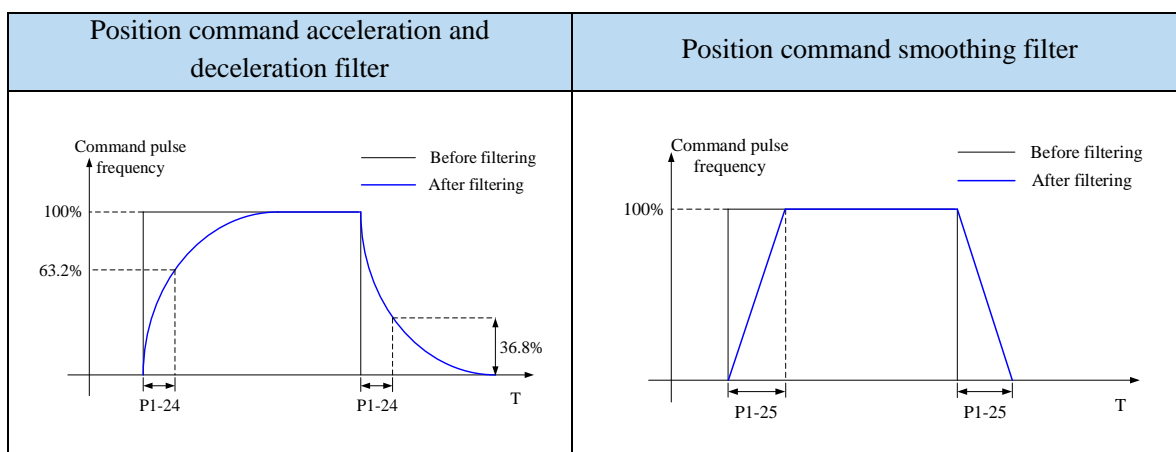

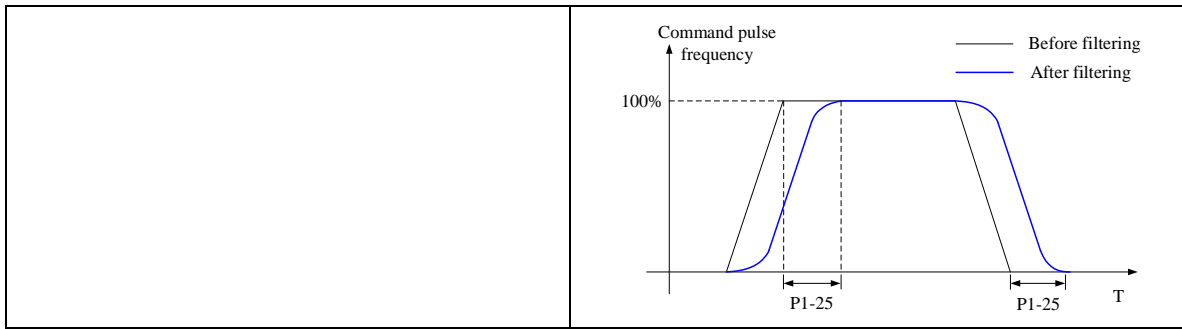

5.3.1.8 Reference origin

1. Find the reference origin

To find out the physical origin of working table and make it as the coordinates origin of point position control. Users can select finding reference origin at forward or reverse side.

Function setting:

Parameter	Meaning	Default setting	Unit	Range	Change	Effective
P4-00 n.XX□X	Origin function	0	-	0~1	Servo OFF	At once

Note: This function is applicable to position mode 5 and 6; when this parameter is set to 0, the function of Origin-finding is invalid; when it is set to n.001x, the function of Origin-finding can be used.

Signal setting

Parameter	Signal	Default	Meaning	Modify
P5-28	/SPD-A	n.0000	Mode 3: internal speed selecting signal	Range: 0000-001A, distributes to input terminal through P5-28. When it set to 0001, it means input signal from SI1.
			Mode 5: find origin point at forward direction	
P5-29	/SPD-B	n.0000	Mode 3: internal speed selecting signal	Range: 0000-001A, distributes to input terminal through P5-29. When it set to 0001, it means input signal from SI1.
			Mode 5: find origin point at reverse direction	

Related parameter setting:

Parameter	Meaning	Default setting	Unit	Range	Change	Effective
P4-00 n.XXX□	Z phase signal numbers	2	-	0~f	Servo OFF	At once
P4-01	The speed hitting the proximity switch	600	rpm	0~65535	Servo OFF	At once
P4-02	The speed leaving the proximity switch	100	rpm	0~65535	Servo OFF	At once

Note: the origin searching function is only for single turn absolute motor (the origin searching function can also be supported for multi turn absolute motor P0-79 =1).

Find reference origin diagram:

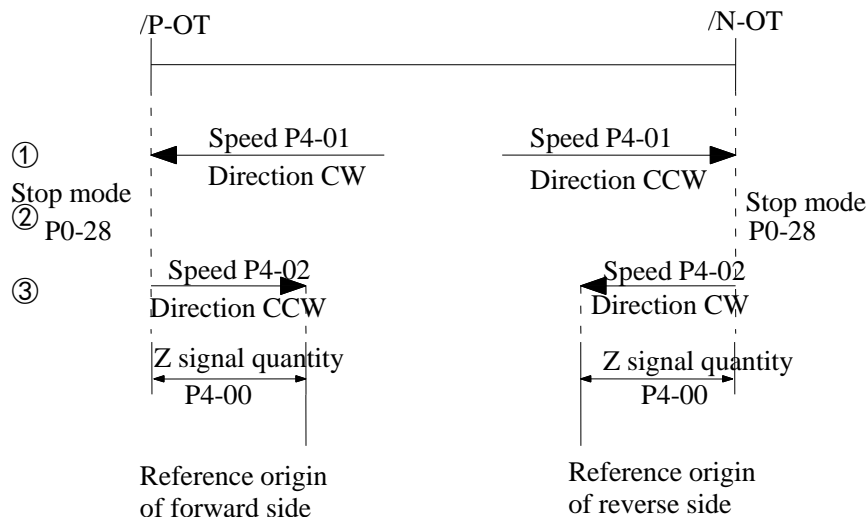

Sequential diagram of finding reference origin on forward side:

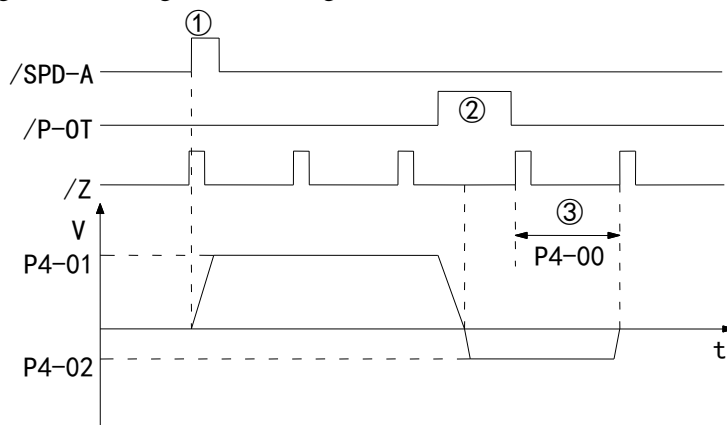

Steps:

- (1) Install limit switch at forward and reverse side. At the rising edge of /SPD-A, motor runs forward at the speed of P4-01 to find the reference origin on forward side.
- (2) After the working table hit the limit switch, the motor stop as the mode set by parameter P0-28
- (3) Motor leaves the limit switch at the speed of P4-02. After the working table left the limit switch, the motor run at the Z phase signal position of No.n optical encoder. This position is considered as the coordinates origin, n is decided by parameter P4-00.

5.3.2 Position control (external pulse command)

Parameter	Overview	Reference chapter
P0-01 control mode selection	Set to 6: external pulse mode	5.3.2.1
P0-10 pulse instruction form	Set the pulse form 0-CW/CCW 1-AB 2-P+D	5.3.2.2
P0-11 Motor pulse numbers per rotation*1 P0-12 Motor pulse numbers per rotation*10000 P0-13 Electronic gear ratio (numerator) P0-14 Electronic gear ratio (denominator) P0-92~P0-93 32-bit electronic gear ratio (numerator) P0-94~P0-95 32-bit electronic gear ratio	Setting of command pulse number required for one revolution of motor P0-11 and P0-12=0, P0-13/P0-14 are effective P0-11~P0-14 are 0, P0-92~P0-95 are valid 32-bit electronic gear ratio (numerator): P0-92*1 + P0-93 *10000	5.3.2.2

(denominator)	32-bit electronic gear ratio denominator: P0-94*1 + P0-95 *10000	
P0-09 Pulse command setting	You can set the command direction and filter time of low-speed pulse respectively	5.3.2.2
P9-00~P9-08	Full closed loop input related configuration	5.3.2.2
P0-88 high speed pulse mode selection	0-general pulse mode 1-high speed pulse mode	5.3.2.2
P0-89 high speed pulse command filter time	Unit: 41.67ns	5.3.2.2

5.3.2.1 External pulse position mode

Parameter	Setting value	Meaning	Modify	Effective
P0-01	6	Control the position by external pulse	Servo OFF	At once

5.3.2.2 Forward direction of pulse instruction and pulse form

1. Pulse input channel switching

parameter	Setting value	Meaning	Modify	Effective
P0-88.0	0	High/low speed pulse command input mode switch: 0: normal pulse command input mode; 1: High speed pulse command input mode.	Servo OFF	Power on again

2. set the forward direction of pulse instruction

Parameter	Meaning	Default setting	Unit	Range	Change	Effective
P0-09.0 n.xxx□	forward direction of pulse instruction	0	-	0/1	Servo OFF	Re-power on
P0-09 will change the counting direction of the internal counter in the servo system. The counting direction determines the rotation direction of the motor. Therefore, this parameter can be adjusted if the actual rotation direction of the motor is different from the expected direction in the position mode.						

Parameter	Meaning	Default setting	Unit	Range	Change	Effective
P0-09.2 n.x□xx	Low speed pulse command filter time	F	4.167ns	0~F	Servo bb	Re-power on
P0-09.2 is pulse filter time. It can enhance the anti-interference ability of low-speed pulses (less than 200K). When the input is less than 700K, the maximum filtering time F is recommended. When the input pulse frequency exceeds 1M, the filtering time should not be more than 7.						

Parameter	Meaning	Default setting	Unit	Range	Change	Effective
P0-09.3 n.□xxx	Predistribution of input pulse command filter	1	-	0~7	Servo bb	Re-power on
P0-09.3 setting value is n (range is 0~7), the received pulse number is 2 ⁿ of normal one. The received frequency is 2 ⁻ⁿ of original one. For example, pulse number per rotation is 10000, sending frequency is 10KHz, pulse number is 10000, when P0-09=1000, then U0-12=5000, U0-00 is 2 ⁻ⁿ of original one.						







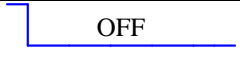
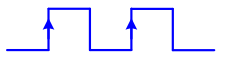
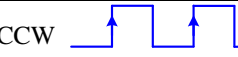
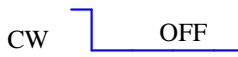
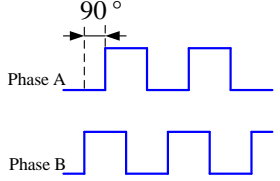
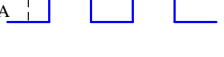

Parameter	Meaning	Default setting	Unit	Range	Change	Effective
P0-89	High speed pulse command filter time	3	41.67ns	0~255	Servo OFF	At once

It is recommended that the filtering time be 1/6 of the input pulse period and not more than 1/2 of the input pulse period.

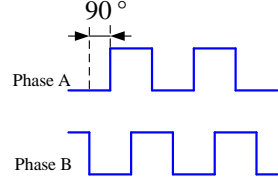
3. set the pulse instruction form

Parameter	Meaning	setting	Meaning	Change	Effective
P0-10 n.XXX□	Pulse command form	0	CW, CCW mode	Servo OFF	At once
		1	AB phase		
		2	Pulse + direction (defaulted)		
P0-10 n.XX□X	Effective edge of pulse signal	0	falling edge is valid		
		1	rising edge is valid		

4. Logical form of instruction pulse

P0-10.0	Forward rotation	Reverse rotation
0: CW/CCW	CCW  CW 	CCW  CW 
1: AB	 Phase A  Phase B 	 Phase A  Phase B 
2: P+D	pulse  direction  ON	pulse  direction  OFF

5. Pulse specification

Pulse specification		Highest input frequency	Voltage	Forward current
High speed pulse	Differential signal	4Mpps	5V	<25mA
Low speed pulse	Differential signal	500Kpps	3.3~5V	<25mA
	Open collector	200Kpps	24V	<25mA

5.3.3 Position control (Internal command)

Parameter	Overview	Reference chapter
P0-01 control mode selection	Set to 5: internal position mode	5.3.3.1
P4-03 internal position mode P4-04 valid segment number P4-10~P4-254 internal position 1 to 35 parameters	Control mode setting of internal position mode; including step change mode, positioning mode and adjustment time Configuration of pulse displacement, speed, acceleration and deceleration time of each segment	5.3.3.3
P5-35 change step signal/GHGSTP P5-32 pause present segment signal /INHIBIT P5-31 jump present segment signal /Z-CLAMP	Common terminal function assignment	5.3.3.4 5.3.1.4 5.3.3.5
P4-00 number of Z-phase signal after leaving limit switch	Internal position back to origin setting parameters	5.3.1.8

P4-01 speed of hitting the proximity switch P4-02 speed of leaving proximity switch P5-28 /SPD-A: find reference origin on forward side in position mode P5-29 /SPD-B: find reference origin on reverse side in position mode		
F2-09 35 segments position setting	Set segment no. by communication	5.3.3.6

5.3.3.1 Internal position mode

Parameter	Setting value	Meaning	Change	Effective
P0-01	5	Position control by preset values of internal registers in servo units	Servo bb	At once

5.3.3.2 Internal position mode setting

Parameter	Function	Unit	Default setting	Suitable mode	modify	Effective
P4-03	Internal position mode setting	—	n.0000	5	Servo bb	At once
	Parameter setting	Meaning	Default setting	Setting range		
	n.□XXX	No meaning				
	n.X□XX	Waiting mode	0	0~1		
	n.XX□X	Change step mode	0	0~6		
n.XXX□	Positioning mode	0	0~1			

1. waiting mode

n.X□XX	Meaning
0	Wait for positioning completion
1	Not wait for positioning completion

Note: Waiting mode refers to whether the driver waits for the motor to be positioned after outputting a position instruction in internal position mode. It takes effect in all Step-Changing modes.

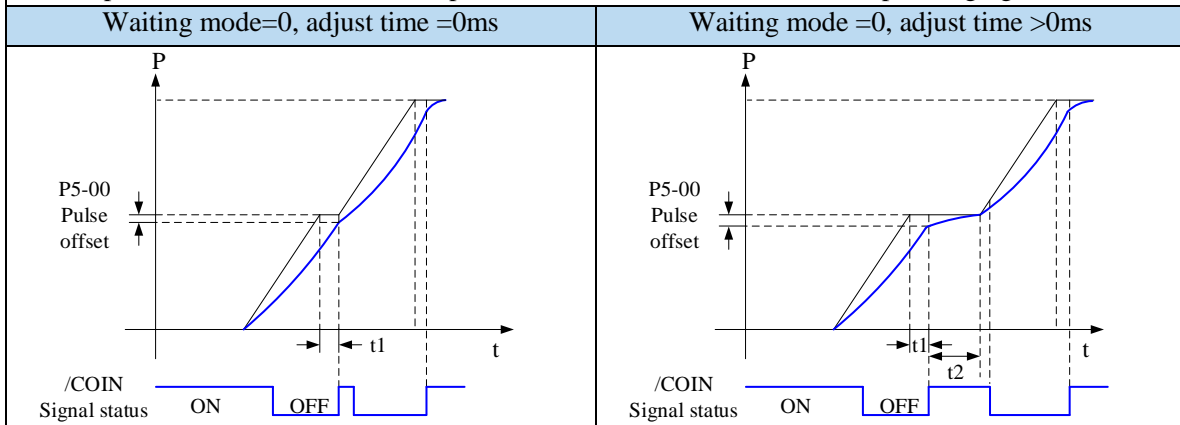

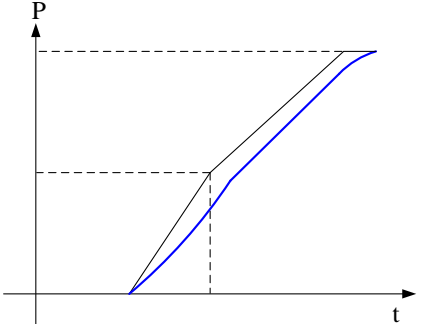
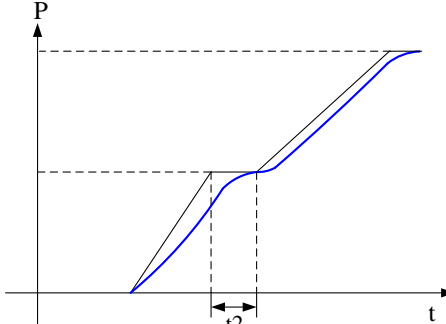
<p>After the drive output 1-segment position command, it will wait for the completion of motor positioning, and then start the next position command at once. T1 is positioning time, which means the time from pulse output complete to the output of positioning completion signal.</p>	<p>After the drive output 1-segment position command, it will wait for the completion of motor positioning, and pass the adjust time, then start the next position command. T1 is positioning time, t2 is adjust time. Refer to parameter P4-11.</p>
<p>Wait mode = 1, adjust time = 0ms</p>	<p>Wait mode = 1, adjust time > 0ms</p>
	
<p>After the drive output 1-segment position command, it will not wait for the completion of motor positioning, and start the next position command at once.</p>	<p>After the drive output 1-segment position command, it will not wait for the completion of motor positioning, but pass the adjust time, and then start the next position command. T2 is adjust time. Refer to parameter P4-11.</p>

2. change step mode

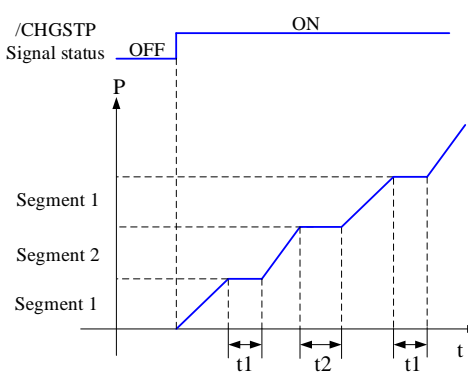
n.XX□X	Description	
<p>0: Change the step when signal is ON, recycling</p>		<p>t1=P4-16, t2=P4-23.</p> <ol style="list-style-type: none"> 1. If the /CHGSTP signal is always on, the servo unit will cycle the set position segment all the time. 2. If the /CHGSTP signal is set to off when executing a certain segment, the servo will continue to complete the execution of that segment without the execution of the next segment. 3. In this mode, the step change signal /CHGSTP is triggered at high level. 4. When the servo enable is off during a certain section of operation, the motor stops according to the servo off shutdown mode. After the shutdown, the positioning is invalid. 5. After each operation completion, positioning completion and positioning approach signal are all effective. 6. In this mode, the adjustment time of each period is valid.

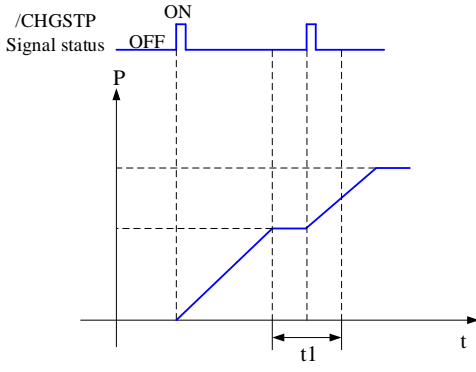
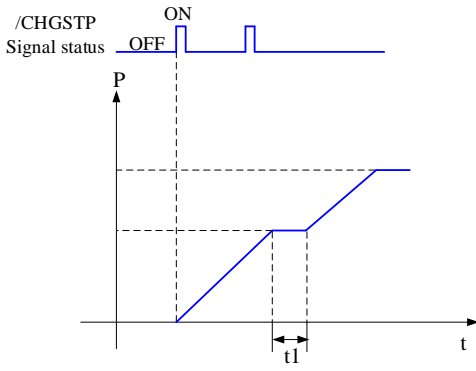
n.XX□X	Description	
<p>1: Change the step at the rising edge of the signal, single-step execution</p>		<p>Take setting two segments as an example, $t1 = p4-16$ in the figure.</p> <ol style="list-style-type: none"> Note that as shown in the figure, in this mode, the set adjustment time actually does not work. As long as the previous position command has been sent out, the next command will be entered immediately when a new step change signal arrives. In this mode, the step change signal /CHGSTP is triggered by rising edge. After each operation completion, positioning completion and positioning approach signal are all effective. When the servo enable is off during a certain section of operation, the motor stops according to the servo off shutdown mode. After the shutdown, the positioning is invalid. The adjustment time is not valid in this mode.
<p>2: Start at the rising edge of the signal, sequential run all, not recycling</p>		<p>Take setting two segments as an example, $t1 = p4-16$ in the figure.</p> <ol style="list-style-type: none"> The /CHGSTP signal before the completion of a cycle will not be counted, as shown in the second /CHGSTP signal in the figure. In this mode, the step change signal /CHGSTP is triggered by rising edge. After each operation completion, positioning completion and positioning approach signal are all effective. When the servo enable is off during a certain section of operation, the motor stops according to the servo off shutdown mode. After the shutdown, the positioning is invalid. The adjustment time is valid in this mode.
<p>3: set segment no. through communication</p>	<p>Servo is ON, set parameter P2-09=0, then set the running segment. The motor will run the setting segment. Refer to chapter 5.4.8.</p>	

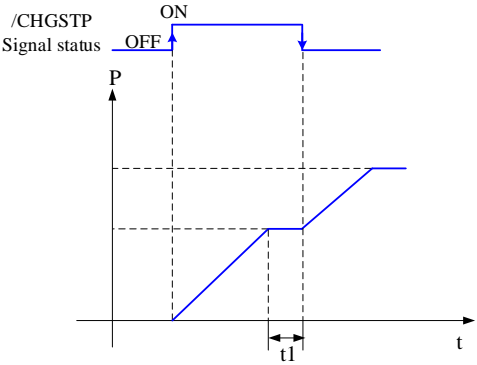
<p>4: /CHGSTP double edge triggering</p>		<p>$t1 = p4-16$ in the figure.</p> <ol style="list-style-type: none"> 1. /CHGSTP rising edge triggers the first segment and falling edge triggers the second segment. Where, if the first segment position is required to operate completely, the /CHGSTP signal remains on until the end of the first segment. 2. Only in this mode, the number of p4-04 valid segments is invalid. 3. After each operation completion, positioning completion and positioning approach signal are all effective. 4. When the servo enable is off during a certain section of operation, the motor stops according to the servo off shutdown mode. After the shutdown, the positioning is invalid. 5. The adjustment time is not valid in this mode. 6. Before using this mode, p5-35 terminals need to be allocated first, but not when using this mode. 																																																											
<p>5: /PREFA(P5-57) /PREFB(P5-58) /PREFC(P5-59) Choose the segment through terminal, the range is segment 1~3</p>	<table border="1" data-bbox="419 1055 1190 1223"> <thead> <tr> <th>/PREFC</th> <th>/PREFB</th> <th>/PREFA</th> <th>Segment no.</th> </tr> </thead> <tbody> <tr> <td>0</td> <td>0</td> <td>0</td> <td>-</td> </tr> <tr> <td>0</td> <td>0</td> <td>1</td> <td>1 (segment 1 position)</td> </tr> <tr> <td>0</td> <td>1</td> <td>0</td> <td>2 (segment 2 position)</td> </tr> <tr> <td>1</td> <td>0</td> <td>0</td> <td>3 (segment 3 position)</td> </tr> </tbody> </table> <ol style="list-style-type: none"> 1. After each operation completion, positioning completion and positioning approach signal are all effective. 2. When the servo enable is off during a certain section of operation, the motor stops according to the servo off shutdown mode. After the shutdown, the positioning is invalid. 3. The adjustment time is valid in this mode. 4. /CHGSTP signal is invalid only in this mode. 5. The segment number selection terminal can not only trigger the step change at the edge, but also keep on state. This mode supports continuous and repeated triggering of a certain segment. If the segment number selection terminal remains on, the motor stops after encountering the overtravel signal, it is necessary to change the segment number selection terminal to off, otherwise, the motor will execute the position segment after the overtravel signal is cancelled. 	/PREFC	/PREFB	/PREFA	Segment no.	0	0	0	-	0	0	1	1 (segment 1 position)	0	1	0	2 (segment 2 position)	1	0	0	3 (segment 3 position)																																								
/PREFC	/PREFB	/PREFA	Segment no.																																																										
0	0	0	-																																																										
0	0	1	1 (segment 1 position)																																																										
0	1	0	2 (segment 2 position)																																																										
1	0	0	3 (segment 3 position)																																																										
<p>6: /PREFA(P5-57) /PREFB(P5-58) /PREFC(P5-59) Choose the segment through terminal, the range is segment</p>	<table border="1" data-bbox="419 1675 1273 2072"> <thead> <tr> <th>/PREFD</th> <th>/PREFC</th> <th>/PREFB</th> <th>/PREFA</th> <th>Segment no.</th> </tr> </thead> <tbody> <tr> <td>0</td> <td>0</td> <td>0</td> <td>0</td> <td>1 (segment 1 position)</td> </tr> <tr> <td>0</td> <td>0</td> <td>0</td> <td>1</td> <td>2 (segment 2 position)</td> </tr> <tr> <td>0</td> <td>0</td> <td>1</td> <td>0</td> <td>3 (segment 3 position)</td> </tr> <tr> <td>0</td> <td>0</td> <td>1</td> <td>1</td> <td>4 (segment 4 position)</td> </tr> <tr> <td>0</td> <td>1</td> <td>0</td> <td>0</td> <td>5 (segment 5 position)</td> </tr> <tr> <td>0</td> <td>1</td> <td>0</td> <td>1</td> <td>6 (segment 6 position)</td> </tr> <tr> <td>0</td> <td>1</td> <td>1</td> <td>0</td> <td>7 (segment 7 position)</td> </tr> <tr> <td>0</td> <td>1</td> <td>1</td> <td>1</td> <td>8 (segment 8 position)</td> </tr> <tr> <td>1</td> <td>0</td> <td>0</td> <td>0</td> <td>9 (segment 1 position)</td> </tr> <tr> <td>1</td> <td>0</td> <td>0</td> <td>1</td> <td>10 (segment 2 position)</td> </tr> <tr> <td>1</td> <td>0</td> <td>1</td> <td>0</td> <td>11 (segment 3 position)</td> </tr> </tbody> </table>	/PREFD	/PREFC	/PREFB	/PREFA	Segment no.	0	0	0	0	1 (segment 1 position)	0	0	0	1	2 (segment 2 position)	0	0	1	0	3 (segment 3 position)	0	0	1	1	4 (segment 4 position)	0	1	0	0	5 (segment 5 position)	0	1	0	1	6 (segment 6 position)	0	1	1	0	7 (segment 7 position)	0	1	1	1	8 (segment 8 position)	1	0	0	0	9 (segment 1 position)	1	0	0	1	10 (segment 2 position)	1	0	1	0	11 (segment 3 position)
/PREFD	/PREFC	/PREFB	/PREFA	Segment no.																																																									
0	0	0	0	1 (segment 1 position)																																																									
0	0	0	1	2 (segment 2 position)																																																									
0	0	1	0	3 (segment 3 position)																																																									
0	0	1	1	4 (segment 4 position)																																																									
0	1	0	0	5 (segment 5 position)																																																									
0	1	0	1	6 (segment 6 position)																																																									
0	1	1	0	7 (segment 7 position)																																																									
0	1	1	1	8 (segment 8 position)																																																									
1	0	0	0	9 (segment 1 position)																																																									
1	0	0	1	10 (segment 2 position)																																																									
1	0	1	0	11 (segment 3 position)																																																									

1~8. Note: ① Firmware version 3730 and later supports 1-8 segments of step change mode 6 ② Firmware version 3740 and later supports 1-16 segments of step change mode 6	1	0	1	1	12 (segment 4 position)
	1	1	0	0	13 (segment 5 position)
	1	1	0	1	14 (segment 6 position)
	1	1	1	0	15 (segment 7 position)
	1	1	1	1	16 (segment 8 position)

Note: the rising edge of P5-35 step change signal triggers each position (the rising edge is invalid during operation).

- When the servo enable is off during a certain section of operation, the motor stops according to the servo off shutdown mode. After the shutdown, the positioning is invalid.
- The adjustment time is not valid in this mode.
- After each operation completion, positioning completion and positioning approach signal are all effective.
- After the segment number is selected, the rising edge of P5-35/CHGSTP step change signal is required to trigger to run the position segment, and the step change triggering during segment operation is invalid.
- Segment number selection terminal logic is voltage level valid. Input high voltage level is valid, input low voltage level is invalid.

The following input signal can switch the segment 1 to 3 or 1 to 16:

Parameter	Signal name	Default setting	Suitable mode	Setting range	Modify	Effective
P5-57	/PREFA internal position segment 1	n.0000	5	Range 0000-001A, distribute to input terminal through P5-57	Anytime	At once
P5-58	/PREFB internal position segment 2	n.0000	5	Range 0000-001A, distribute to input terminal through P5-58		
P5-59	/PREFC internal position segment 3	n.0000	5	Range 0000-001A, distribute to input terminal through P5-59		
P5-60	/PREFD internal position segment 3	n.0000	5	Range 0000-001A, distribute to input terminal through P5-60		

3. Positioning mode

n.XXX□	Meaning
0	Relative positioning
1	Absolute positioning
0: relative positioning	1: absolute positioning (take the reference origin as the absolute positioning origin)

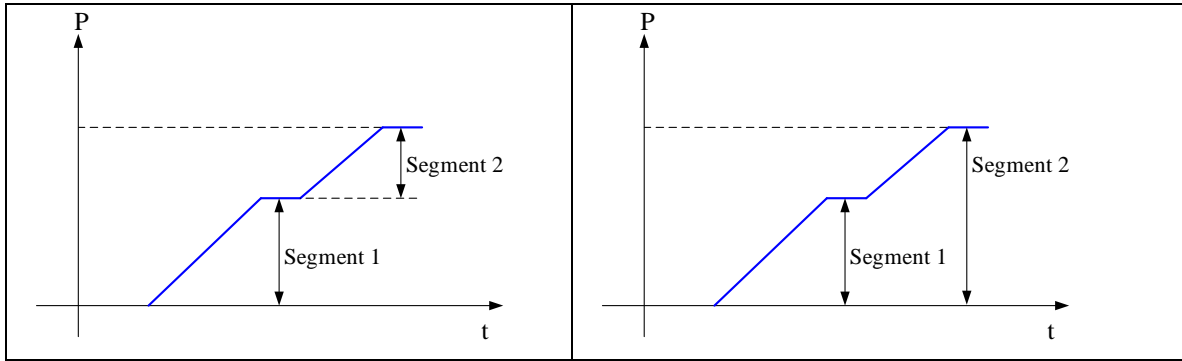

5.3.3.3 Position segment 1 to 35 parameter settings

Parameter	Meaning	Default setting	Unit	Range	Change	Effective
P4-10+ (n-1) *7	Pulse number (low bit)	0	1 pulse	-9999~9999	Servo bb	At once
P4-11+ (n-1) *7	Pulse number (high bit)	0	10000 pulses	-32767~32767	Servo bb	At once
P4-12+ (n-1) *7	Speed	0	0.1rpm	0~65535	Servo bb	At once
P4-13+ (n-1) *7	Trapezoid acceleration time	0	ms	0~65535	Servo bb	At once
P4-14+ (n-1) *7	Trapezoid deceleration time	0	ms	0~65535	Servo bb	At once
P4-15+ (n-1) *7	Reserved	-				
P4-16+ (n-1) *7	Adjust time	0	ms	0~65535	Servo bb	At once

Notes:

1. Set pulse number = pulse number (high bit) ×10000 + pulse number (low bit).
2. In formula P4-10+(n-1)*7, n is the segment no. of internal position; the range is 1~35. Segment 1~12 can be set through the operate panel, segment 13~35 needs to write in parameters through communication (RS232 or RS485).
3. If one of the segment speed is zero, servo will skip this segment and run the next segment.
4. In relative positioning mode, if one segment speed is not zero but the pulse number is zero, the motor will not run, but the wait mode is effective. The servo will run the next segment when the adjust time is out.
5. In absolute positioning mode, if one segment speed is not zero but the pulse number is zero, the motor will return to the reference origin with the speed of this segment.
6. In absolute positioning mode, if two consecutive segments speed are not zero, but the pulse number is the same, the servo motor will not run but the wait mode is effective.

Parameter	Meaning	Default setting	Range	Change	Effective
P4-04	Effective segment	0	0~35	Servo bb	At once

There are 35 sections in total in the internal position. If 10 sections need to be operated and 5 sections need to be operated switched for use due to process requirements, the effective segment can be set. For example, parameters are set for sections 1-10, and P4-04 is set to 5, that is, the position of section 1-5 is valid; if it is set to 10, the position of section 1-10 is valid.

Parameter	Meaning	Default setting	Unit	Range	Modify	Effective
P4-08	Internal position mode start segment number	1	-	0~35	Servo bb	At once

P4-08 sets the starting operation section number after the first round, and it is valid when the change mode P4-03.1 is set to 0 and 1. The settings are explained below, and valid values are set for No.1-No.8 sections.

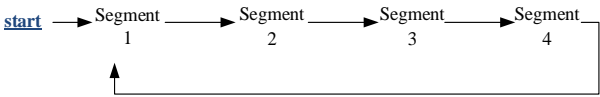
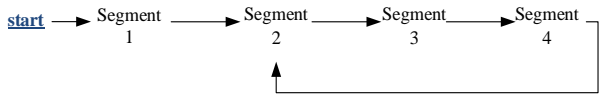
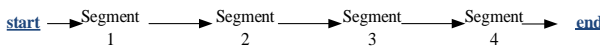
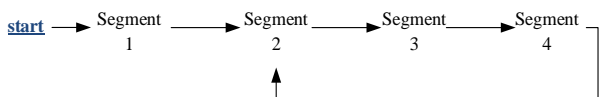
Change step mode	Setting	Parameter	Actions
P4-03.1=0	P4-08=0 or P4-08>P4-04	P4-08=8 P4-04=4	
	1≤P4-08≤P4-04	P4-08=2 P4-04=4	
P4-03.1=1	P4-08=0 or P4-08>P4-04	P4-08=8 P4-04=4	
	1≤P4-08≤P4-04	P4-08=2 P4-04=4	

5.3.3.4 Change step signal (/CHGSTP)

Parameter	Name	Setting	Meaning	Range
P5-35	Change step signal /CHGSTP	n.0000	Defaulted is not distribute to input terminal. Refer to chapter 5.4.2.	Range: 0000-001A. Distribute to input terminal through P5-35. When it set to 0001, it means input from S11.

5.3.3.5 Skip present segment signal (/ZCLAMP)

Parameter	Signal name	Setting	Meaning	Range
P5-31	Skip the present segment /Z-CLAMP	n.0000	Defaulted is not distribute to input terminal.	Range: 0000-001A. Distribute to input terminal through P5-31. When it set to 0001, it means input from S11.

In different Step-Changing modes, the function of skipping the current segment will have different effects, as follows:

Change step mode P4-03 n.xx□x	Skip the present segment	Actions
0	/Z-CLAMP	Cancel current segment, execute the next segment at once
1		Cancel current segment, execute the next segment when the change step signal is ON
2		Cancel current segment, execute the next segment at once
3		Cancel current segment, set the F2-09 again

5.3.3.6 Set segment thorough communication

Parameter	Meaning	Default setting	Unit	Range	Modify	Effective
F2-09	Set the segment number through communication	0	-	0~35	Anytime	At once

If this parameter is set to a certain segment number, this segment position will be executed without step change signal. Communication can be used to modify parameters.

For example: to execute the second segment position, set F2-09 = 0, and then F2-09 = 02.

5.3.3.7 Motion start signal (/MRUN)

Parameter	Signal name	Default setting	Meaning	Modify
P5-50	Motion start /MRUN	n.0000	Terminal output is not assigned by default. It is only valid in the internal position mode, similar to the positioning completion signal in the external pulse mode; there is output when the motor is running, and there is no output when the motor stops.	Parameter range 0000-0018, assigned to the output interface through parameter P5-50. When it is set to 0001, the signal is output from SO1 terminal.

5.4 Speed control

5.4.1 Speed mode general control

5.4.1.1 Soft start

Parameter	Meaning	Defaulted setting	Unit	Range	Modify	Effective
P3-09	Soft Start Acceleration Time	0	ms	0~65535	Servo bb	At once
P3-10	Soft Start deceleration Time	0	ms	0~65535	Servo bb	At once

Soft start acceleration and deceleration time is suitable for mode 3/4/7. Smooth speed control can be carried out when step speed instruction is input or internal setting speed is selected.

P3-09: Time from stop to rated speed

P3-10: Time from rated speed to stop

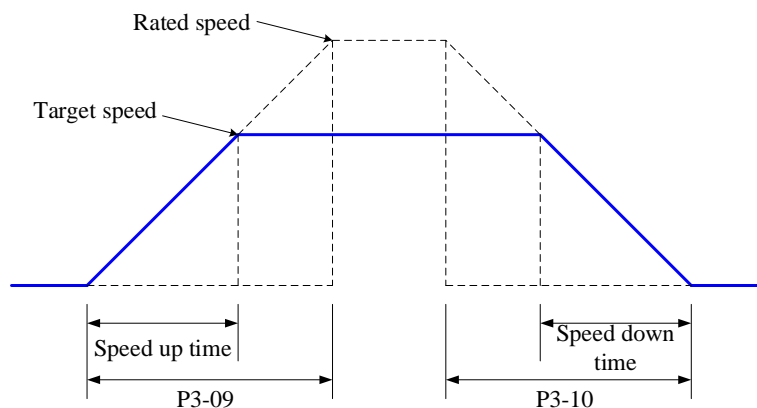

5.4.1.2 Zero clamp (/ZCLAMP)

1. Overview

This function is used when host controller uses speed command input and the servo system isn't configured the position loop. In other words, the function will be used when the motor must stop and enter lock state even the V-REF input voltage is not zero.

When set ON the zero clamp function, it will configure the position loop inside the servo, the motor will do zero clamp within ± 1 pulse at this position. The motor will return to zero clamp position even it is run by external force.

The present speed must be smaller than zero clamp speed when using zero clamp function, it can clamp the motor shaft from moving. The motor will switch from speed mode to position mode when starting the zero clamp function. At this time, rotate the motor shaft, it will return to the original position. It will not return to original position in speed mode, because it has no position feedback.

2. Input signal setting

Parameter	Signal	Setting	Meaning	Range
P5-31	Zero clamp /ZCLAMP	n.0000 (default)	Defaulted is not distribute to input terminal	/Z-CLAMP signal is distributed to input terminal by parameter P5-31, Range: 0000-001A.
		n.0002	Input signal from SI2 terminal	

3. Parameter setting

parameter	Meaning	Default setting	Unit	Range	Change	Effective
P3-13	Zero clamp speed	10	rpm	0~300	Servo bb	At once
P3-12	Zero clamp mode	0	-	0~3	Servo bb	At once

P3-12 setting	Contents
0	ZCLAMP input signal is ON, forced speed command is 0, when the speed below P3-13, switch to position mode and the servo lock in this position.
1	ZCLAMP input signal is ON, forced set the speed command to 0.
2	ZCLAMP input signal is ON, the speed below P3-13, switch to position mode and the servo lock in the position. Note: after entering zero clamp mode, present setting speed is higher than P3-13, motor doesn't run, the ZCLAMP signal must be OFF, then motor will run again.
3	ZCLAMP signal is ON, the setting speed is less than P3-13, switch to position control mode, and servo is locked at this position. At this time, if setting speed is over P3-13, the motor will run again.

5.4.1.3 Speed reach signal (/V-RDY)

■ Related parameter

Parameter	Signal	Default setting	Suitable mode	Meaning	Modify	Effective
P5-51	/V-RDY	n.0000	3, 4, 7	Speed reach signal	Anytime	At once

Parameter	Meaning	Default setting	Unit	Range	Modify	Effective
P5-05	Reach speed	50	rpm	0~10000	Anytime	At once

Speed arrival signal output condition

When the actual motor speed is greater than P5-05, output speed reach signal (/V-RDY).

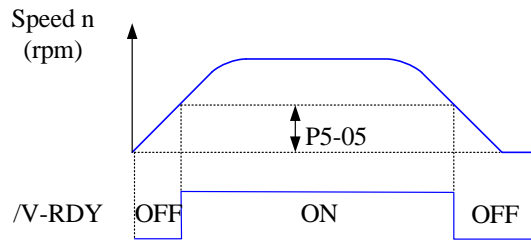

5.4.1.4 Speed command filter

■ Related parameter

Parameter	Meaning	Default setting	Unit	Range	Modify	Effective
P1-22	Speed command filter selection	0	-	0~1	Servo bb	At once
P1-23	Speed command filter time	0	0.1ms	0~65535	Servo bb	At once

P1-22	Contents
0	First-order Inertial Filter
1	Smooth filter

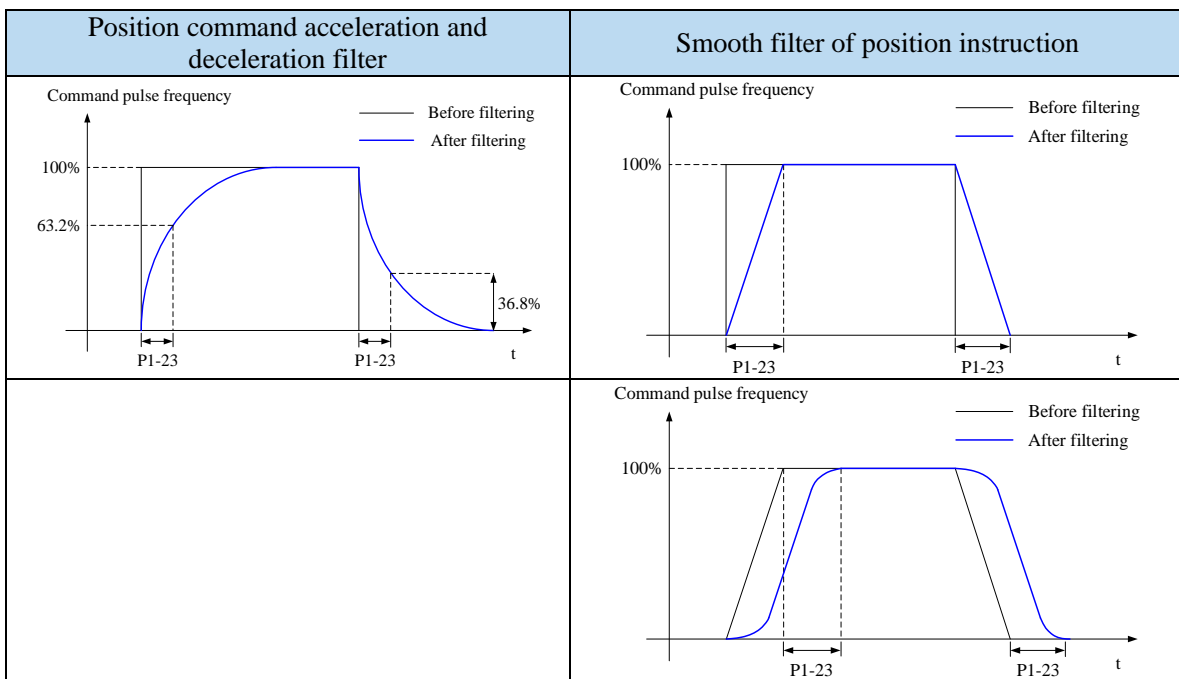

5.4.2 Speed control (internal speed)

Parameter	Overview	Chapter
P0-01 Control mode selection	Set to 3: internal speed control mode	5.4.2.1
P3-05 Internal speed 1 P3-06 Internal speed 2 P3-07 Internal speed 3	Speed value setting of internal 3-segment speed in rpm	5.4.2.1
P5-28 internal speed selection /SPD-A P5-29 internal speed selection /SPD-B	The combination of terminals determines the speed of corresponding section	5.4.2.1
P5-27 internal speed direction selection /SPD-D	Direction changing, default is n.0000 If the direction changing is given through SI2 terminal, P5-27 can be set to n.0002	5.4.2.1
P3-09 soft start acceleration time P3-10 soft start deceleration time	Set acceleration and deceleration time in ms	5.4.1.1

5.4.2.1 Internal speed mode

Parameter	Set value	Meaning	Modify	Effective
P0-01	3	Speed control: internal speed selection	Servo bb	At once
<p>Function: internal speed selection will set 3 motor speeds and select the speed by external signal. It is no need to configure external speed generator or pulse generator.</p>				

■ Related parameter

Parameter	Meaning	Defaulted setting	Unit	Range	Modify	Effective
P3-05	Internal speed 1	0	rpm	-9999~+9999	Anytime	At once
P3-06	Internal speed 2	0	rpm	-9999~+9999	Anytime	At once
P3-07	Internal speed 3	0	rpm	-9999~+9999	Anytime	At once

Parameter	Signal	Default setting	Range	Modify	Effective
P5-27	Internal direction /SPD-D	n.0000	Range: 0000-001A. Distribute to input terminal through P5-27.	Anytime	At once
P5-28	Internal speed /SPD-A	n.0000	Range: 0000-001A. Distribute to input terminal through P5-28.		
P5-29	Internal speed /SPD-B	n.0000	Range: 0000-001A. Distribute to input terminal through P5-29.		

1. Correlation between running speed and terminal signal

Input signal			Running speed
SPD-D (P5-27)	SPD-A (P5-28)	SPD-B (P5-29)	
0: forward run	0	0	Internal speed is zero
	0	1	P3-05: SPEED1
	1	1	P3-06: SPEED2
	1	0	P3-07: SPEED3
1: reverse run	0	0	Internal speed is zero
	0	1	P3-05: SPEED1
	1	1	P3-06: SPEED2

	1	0	P3-07: SPEED3
--	---	---	---------------

Note:

(1) /SPD-D signal is direction control, input SI terminal can be changed according to P5-27. The validity of the terminal signal determines the direction of the motor.

(2) The combination of /SPD-A and /SPD-B input terminal effectiveness determines the multi segment speed

(3) 0/1 of the above table represent the validity of the signal. The 0-bit terminal input is invalid. 1 is the terminal input valid.

2. Terminal effectiveness description

The following table takes /SPD-D as an example, /SPD-A, /SPD-B signals are the same.

Parameter setting	Signal/SPD-D terminal input status	Signal/SPD-D terminal logic
P5-27=n.0000	No need external terminal input	Invalid
P5-27=n.000□	SI□ terminal no signal input	
P5-27=n.001□	SI□ terminal has signal input	
P5-27=n.0010	No need external terminal input	Valid
P5-27=n.000□	SI□ terminal has signal input	
P5-27=n.001□	SI□ terminal no signal input	

3. Running example

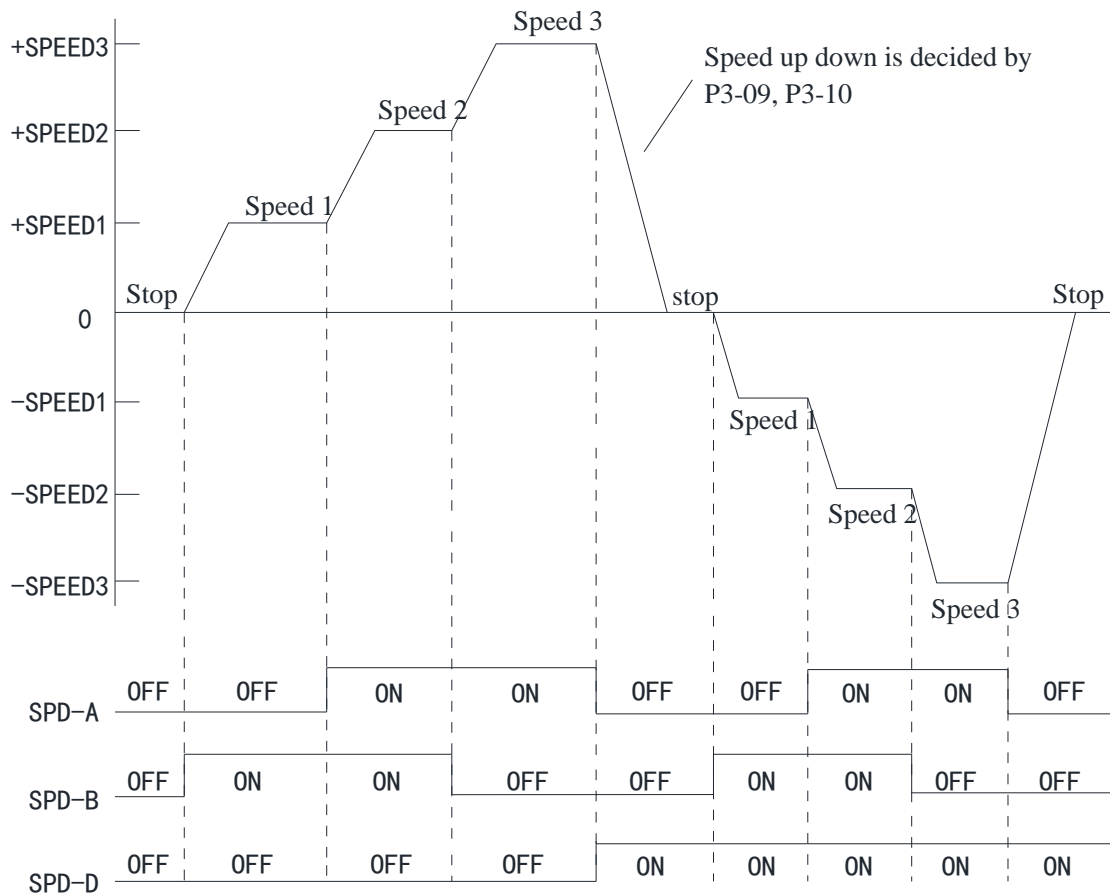

5.4.3 Speed control (pulse frequency command)

Parameter	Overview	Reference chapter
P0-01 Control mode selection	Set to 7: external pulse speed mode	5.4.3.1
P0-10 Pulse command form	Set pulse form 0-CW/CCW 1-AB 2-P+D	5.3.2.2
P0-15 Command pulse frequency at rated speed	Determine the linear relationship between the command pulse frequency and the speed	5.4.3.3
P0-16 Speed command pulse filter time	When the command pulse frequency is relatively low, setting this parameter properly can reduce the speed fluctuation	5.4.3.4
P5-71 Function selection of direction terminal in pulse speed mode	change the pulse direction	5.4.3.5

5.4.3.1 External pulse speed mode

Parameter	Setting value	Meaning	Modify	Effective
P0-01	7	Speed control: pulse frequency speed command	Servo bb	At once
Function: speed command is decided by external pulse frequency, but not related to pulse quantity. The wiring is the same as position command. Select CW, CCW mode or direction + pulse mode, AB phase pulse mode.				

5.4.3.2 Pulse frequency command

Pulse frequency command is the same as external pulse command position control, refer to chapter 5-3-2.

5.4.3.3 Command pulse frequency at rated speed

Parameter	Meaning	Default setting	Unit	Range	Modify	Effective
P0-15	command pulse frequency at rated speed	1000	100Hz	0~10000	Servo bb	At once
Note: the unit is 100Hz. Example: P0-15=300, command pulse frequency at rated speed=30kHz; P0-15=1000, command pulse frequency at rated speed= 100kHz.						

5.4.3.4 Speed command pulse filter time

Parameter	Meaning	Default setting	Unit	Range	Modify	Effective
P0-16	speed command pulse filter time	100	0.01ms	0~10000	Servo bb	At once
When the command pulse frequency is low, setting a suitable value for this parameter can decrease the speed fluctuation.						

5.4.3.5 Speed command pulse direction

Parameter	Meaning	Default setting	Unit	Range	Modify	Effective
P5-71	Function selection of direction terminal in pulse speed mode	0	-	0~1	Servo bb	At once

5.4.4 Speed control (external analog value)

Parameter	Overview	Reference chapter
P0-01 Control mode selection	Set to 4: external analog value	5.4.4.1
P3-00 Analog voltage corresponding to rated speed	Set the speed command voltage required to run the servo motor at rated speed, unit: 0.001V	5.4.4.2
P3-09 Soft start acceleration time	Set the acceleration deceleration time, unit ms	5.4.1.1
P3-10 Soft start deceleration time		
P3-02 analog voltage speed filter	Unit 0.01ms	5.4.4.3
P3-03 speed command input dead time voltage	Unit 0.001V	5.4.4.6
P3-04 analog speed direction switching	Switch the input direction of analog speed command	5.4.4.4

5.4.4.1 External analog speed mode

Parameter	Setting value	Meaning	Modify	Effective
P0-01	4	Speed control: external analog value	Servo bb	At once
Function: speed command is given by external analog quantity. The analog voltage command input from the V-REF terminal is given as the speed control signal to control the speed.				

Note:

- (1) Direction switching: positive and negative voltage or SPD-D (P5-27) can control direction.
- (2) Refer to section 3.2.4 analog input circuit for hardware wiring.

5.4.4.2 Analog value corresponding to rated speed

Parameter	Meaning	Default setting	Unit	Setting range	Modify	Effective
P3-00	V-REF function distribution	0	-	0~2	Servo bb	At once
P3-01	Analog quantity corresponding to rated speed	10000	0.001V	1500~30000	Servo bb	At once

Function description: set the speed command voltage (V-REF) required to run the servo motor at rated speed.

For example, P3-01 = 5000, indicating that when the analog input voltage is 5.00V, the motor operates at the rated speed;

P3-01 = 8000, indicating that when the analog input voltage is 8.00V, the motor operates at the rated speed.

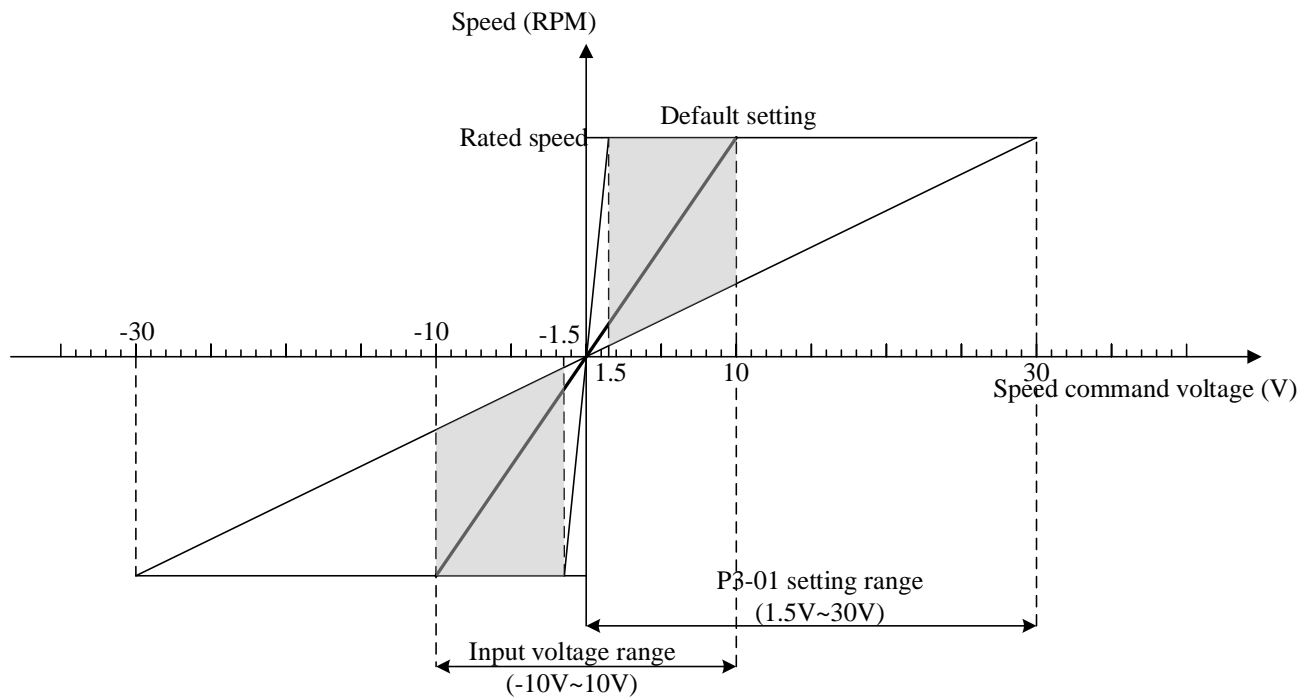

Note:

- (1) The input of the analog voltage command for the speed limit has no polarity. No matter in positive voltage or in negative voltage, the absolute value is adopted. The speed limit value based on the absolute value is applicable to the two directions of forward rotation and reverse rotation.
- (2) The maximum allowable voltage of analog input signal is $\pm 10V$. Do not apply voltage above $\pm 10V$.

5.4.4.3 Analog voltage speed filter

Parameter	Meaning	Default setting	Unit	Setting range	Modify	Effective
P3-02	analog voltage speed filter	0	0.01ms	0~10000	Anytime	At once

5.4.4.4 Analog speed direction switching

There are three ways of analog speed control to achieve direction switching:

- ① Change of control parameters, ② positive and negative voltage, ③ /SPD-D (P5-27) pulse signal

Parameter	Meaning	Default setting	Unit	Setting range	Modify	Effective
P3-04	analog speed direction switching	0	-	0~1	Anytime	At once

5.4.4.5 Speed command offset auto-tune (F1-03)

When using the analog voltage speed mode, even if the command voltage is 0V, the motor will rotate at a small speed. This fretting occurs when the command voltage of the upper control unit or the external circuit deviates by a small amount (mV). In this case, the panel operator can be used to adjust the instruction offset automatically.

When the servo is turned off, i.e. bb state, unplug the analog signal of CN1 port of the driver, and carry out the following operations:



Press STATUS/ESC button to exit.

Note:

- (1) The current voltage of analog quantity is 0V. If it is calibrated according to F1-03 process above,

0V is 0RPM. If it is lower than 0V, the motor reverse runs, and the motor forward runs when it is higher than 0V. If the current voltage of analog quantity is 5V, then 5V is 0RPM. If it is lower than 5V, the motor reverse runs, and the motor forward runs when it is higher than 5V.

(2) If there is still fretting after the offset is adjusted automatically, zero clamping can be used or the parameter P3-03 can be increased appropriately. If it is changed to 5, it means the dead band voltage is 0.005v.

5.4.4.6 Speed command input deadband voltage

Parameter	Meaning	Default setting	Unit	Setting range	Modify	Effective
P3-03	Speed command input deadband voltage	0	0.001V	0~500	Anytime	At once
P3-47	V-REF zero drift correction of analog value	0	-	-1000~1000	Anytime	At once
P3-58	V-REF analog voltage bias	0	mV	-9999~9999	Anytime	At once

Note:

(1) When the input speed command voltage is within the range set by this parameter, the input command is considered as 0.

(2) If there is any fretting after the offset is adjusted automatically, the dead time voltage can be increased properly.

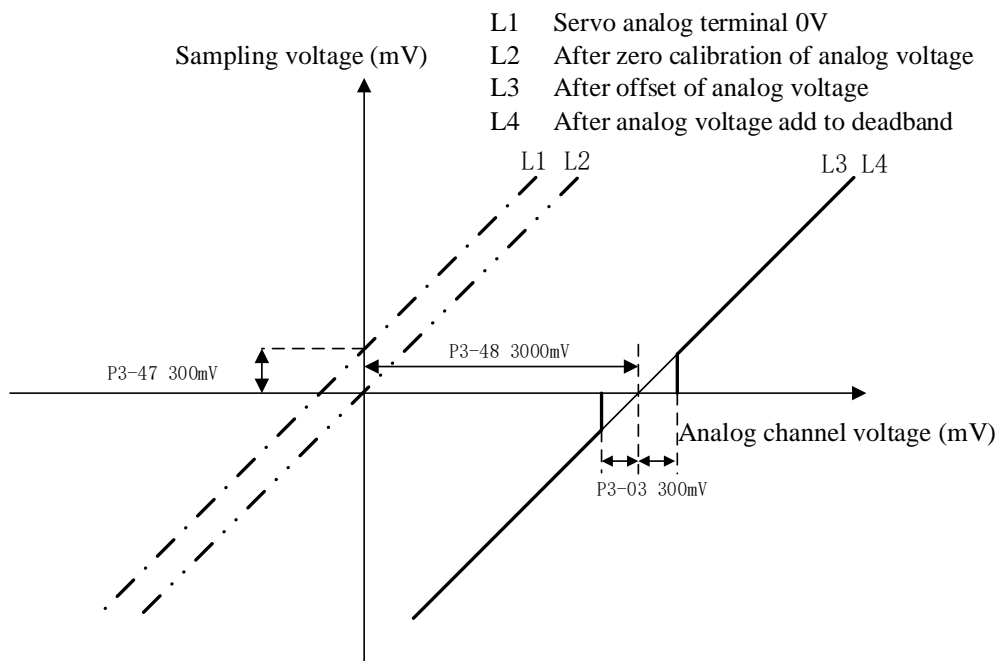

5.5 Torque control

5.5.1 Torque general mode

5.5.1.1 Internal speed limit of torque control

Parameter	Meaning	Default setting	Unit	Range	Modify	Effective
P3-16	internal forward speed limit in torque control mode	Motor rated	rpm	5~65535	Anytime	At once
P3-17	internal reverse speed limit in torque control mode	Motor rated	rpm	5~65535	Anytime	At once

Note: Even if the setting speed of this parameter is greater than the speed limit of P3-14, the actual effective speed limit is the lower speed limit. (The maximum speed is the smaller value in P3-14/P3-15 and P3-16/P3-17)

5.5.1.2 Speed reach signal output (/VLT)

In torque mode, when the absolute value of the actual speed of the servo motor exceeds the speed limit value, it is considered that the actual speed of the servo motor is limited. At this time, the servo driver can output /VLT signal. Otherwise, if any condition is not met, the speed limit signal is invalid.

Parameter	Signal name	Default setting	Suitable mode	Meaning	Modify	Effective
P5-43	/VLT	n.0000	1, 2	Speed limit detection	Anytime	At once

By default, no terminal is allocated, the parameter range is 0000-0014, and is allocated to the output interface through parameter P5-43. When set to 0002, the signal is output from the SO2 terminal. /VLT signal is only valid in torque mode.

5.5.2 Torque control (internal setting)

Parameter	Overview	Reference chapter
P0-01 Control mode selection	Set to 1: internal torque mode	5.5.2.1
P3-33 Internal torque command	The given value is the percentage of rated torque	5.5.2.2
P3-16 Internal forward speed limit of torque control P3-17 Internal reverse speed limit of torque control P3-14 Forward max speed limit (MAX speed) P3-15 Reverse max speed limit (MAX speed)	Speed limit in torque mode	5.5.1.1
P5-27 Speed direction switch /SPD-D	Change the direction, default is n.0000 If it is given through SI2 terminal, P5-27 can be set to n.0002	

5.5.2.1 Internal torque mode

Parameter	Set value	Function	Modify	Effective
P0-01	5	Torque control: internal setting	Servo bb	At once

Function: Control the torque by internal torque command.

5.5.2.2 Internal torque command

Parameter	Meaning	Default setting	Unit	Range	Modify	Effective
P3-33	Internal torque command	0	1% rated torque	-1000~+1000	Anytime	At once

The unit of this parameter is 1% of the rated torque.
 For example: P3-33=50, motor forward run with 50% of the rated torque;
 P3-33= -20, motor reverse run with 20% of the rated torque.
 In addition to using the torque to control the direction of servo operation, it can also use / SPD-D to control the direction.

5.5.3 Torque control (external analog value)

Parameter	Overview	Reference chapter
P0-01 Control mode selection	Set to 2: external analog mode	5.5.3.1
P3-24 analog voltage corresponding to rated torque	Set the speed command voltage required to run the servo motor at rated speed, unit: 0.001V	5.5.3.2
P3-25 analog voltage torque command filter	Unit 0.01ms	5.5.3.3
P3-26 torque command input deadband voltage	Unit 0.001V	5.5.3.5

5.5.3.1 Analog torque mode

Parameter	Setting value	Function	Modify	Effective
P0-01	2	Torque control: analog voltage command	Servo OFF	At once

Function overview: use the analog voltage input from T-REF terminal as the command input to carry out torque control.

Note:

- (1) Direction switching: positive and negative voltage or SPD-D (P5-27) can control direction.
- (2) Refer to section 3.2.4 for hardware wiring.

5.5.3.2 Analog value corresponding to rated torque

Parameter	Meaning	Default setting	Unit	Setting range	Modify	Effective
P3-23	T-REF function distribution	0	-	0~2	Servo bb	At once
P3-24	Analog value corresponding to rated torque	10000	0.001V	1500~30000	Servo bb	At once

Function description: set the torque command voltage (T-REF) required to run the servo motor at rated torque.

For example, P3-24 = 5000, indicating that when the analog input voltage is 5.00V, the motor operates at the rated torque;

P3-24 = 8000, indicating that when the analog input voltage is 8.00V, the motor operates at the rated torque

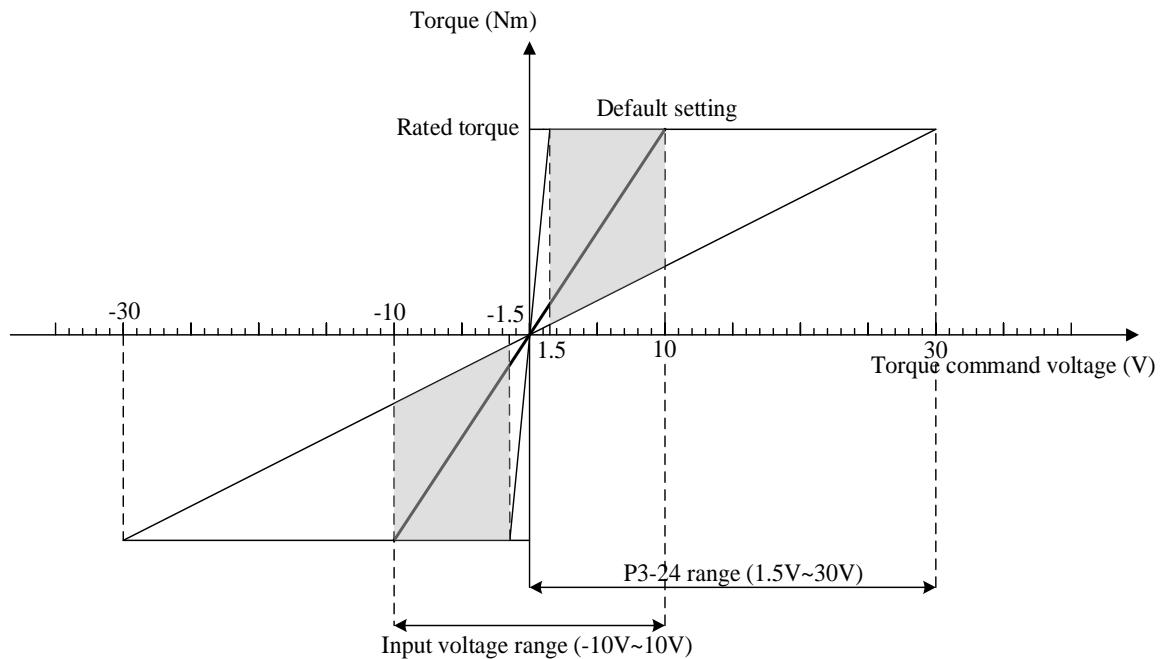

Note:

(1) The input of the analog voltage command for torque limitation has no polarity. The torque limit value based on the absolute value is applicable to the two directions of forward rotation and reverse rotation.

(2) The maximum allowable voltage of the analog input signal is $\pm 10V$. Do not apply more than $\pm 10V$ to the motor.

5.5.3.3 Analog voltage torque filter

Parameter	Meaning	Default setting	Unit	Range	Modify	Effective
P3-25	Analog voltage torque command filter	0	0.01ms	0~10000	Anytime	At once

Make the torque command input pass through the delay filter to smooth the torque command. Setting too large will reduce responsiveness.

5.5.3.4 Torque command offset auto-tune (F1-04)

When analog voltage torque mode is used, the immediate command voltage is 0V, and the motor rotates at a small speed. This fretting occurs when the command voltage of the upper control unit or the external circuit deviates by a small amount (mv). In this case, the panel operator can be used to adjust the instruction offset automatically.

When the servo enable is turned off, i.e. bb state, unplug the analog signal of CN1 port of the driver, and carry out the following operations:



Press STATUS/ESC to exit.

Note:

(1) The current voltage of analog quantity is 0V, calibrated according to F1-04 process above, 0V is 0% output torque, lower than 0V motor reverse output torque, higher than 0V motor forward output torque; similarly, if the current voltage of analog quantity is 5V, calibrated according to F1-04 process above, 5V is 0% output torque, lower than 5V motor reverse output torque, higher than 5V motor forward output torque.

(2) If there is still fretting after the offset is adjusted automatically, increase the parameter P3-26 appropriately. If it is changed to 5, it means the dead band voltage is 0.005v.

5.5.3.5 Torque command input dead band voltage

Parameter	Meaning	Default setting	Unit	Range	Modify	Effective
P3-26	Torque command input deadband voltage	0	0.001V	0~500	Anytime	At once
P3-49	T-REF analog zero offset correction	0	-	-1000~1000	Anytime	At once
P3-50	T-REF analog voltage offset	0	mV	-9999~9999	Anytime	At once

Note:

(1) When the input torque command voltage is less than the set value of this parameter, the input torque command is considered as 0.

(2) If there is any fretting after the offset is adjusted automatically, the dead time voltage can be increased properly.

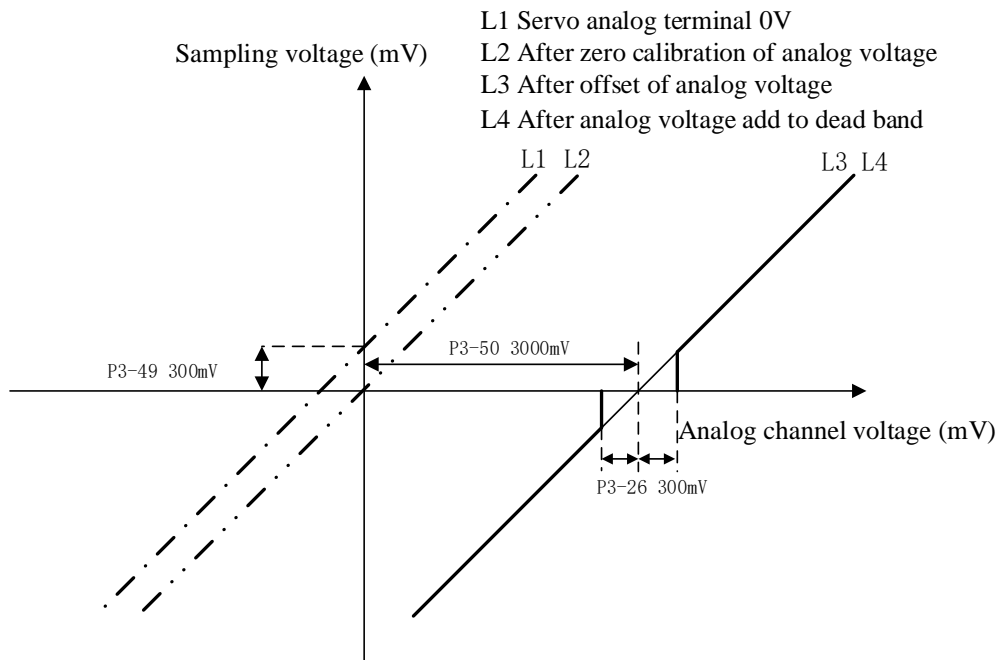

5.6 Absolute value system

5.6.1 Absolute system setting

In order to save the position data of absolute encoder, the battery unit needs to be installed.

Install the battery on the battery unit of the encoder cable with the battery unit.

If you do not use encoder cable with battery unit, please set P-79 to 1, that is, multi-loop absolute value encoder is used as incremental encoder.

Parameter	Name	setting	Meaning	Range
P0-79	Absolute encoder battery undervoltage alarm switch	0	Normally use absolute encoder and use battery to memorize position.	0~2
		1(default)	Use multi-loop absolute encoder as incremental encoder and no longer remember position	
		2	Use as absolute encoder, ignore the multi-loop overflow alarm	

5.6.2 Replace the battery

When replacing the battery, please replace the battery while keeping the driver and motor connected well and the control power is connected. If the battery is replaced when the control power between the driver and the motor is closed, the data stored in the encoder will be lost.

Note: Absolute Encoder Battery Model (This Battery Can't Charge)

Battery unit for normal cable:CP-B-BATT

Battery unit for tank chain cable: CPT-B-BATT

Battery replacement steps

When using encoder cable with battery unit

- (1) Only the control power of the servo unit is connected;
- (2) Open the cover of the battery cell;

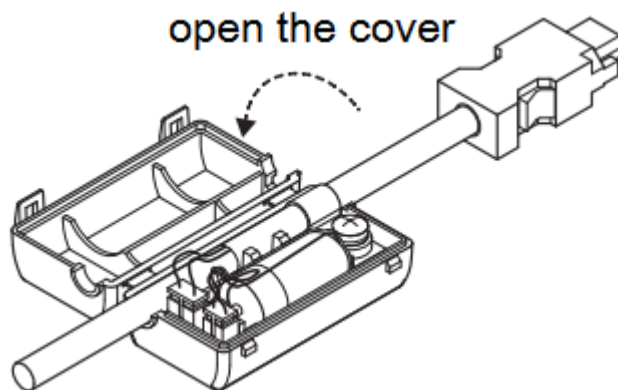

- (3) Take out the old battery, install the new one.

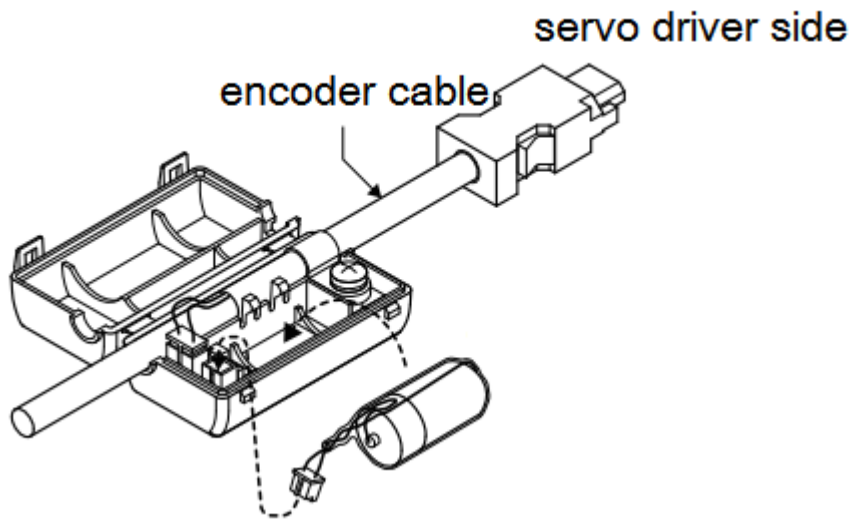

(4) Close the cover of the battery unit

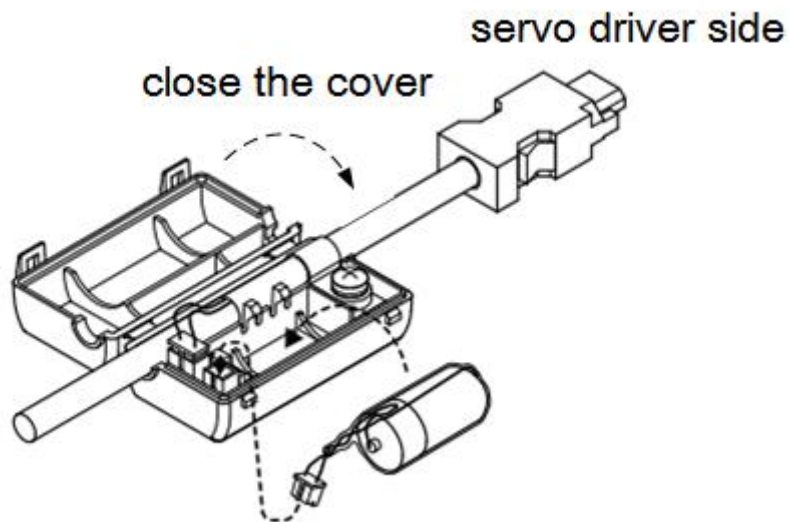

(5) After replacing the battery, in order to remove the "Encoder Battery Alarm (E-222)" display, please do clear alarm twice (F0-00=1).

(6) Connect the power supply of the servo unit again;

(7) Make sure the error display disappears and the servo unit can operate normally.

5.6.3 The upper limit of turns

The upper limit of rotating cycles can be used for position control of gyroscopes such as turntables.

For example, suppose there is a machine whose turntable moves only in one direction, as shown in the figure below.

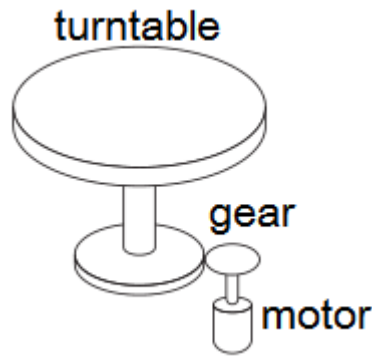

Because it can only rotate in one direction, after a certain period of time, the number of revolving cycles will always exceed the upper limit of absolute value encoder.

Servo motor series	Resolution (single-circle data)	Rotating Circle Serial Data Output range	Operation of overtime
CM/T	17	-32768~32767	When it is higher than the upper limit value in the forward direction ($+32767*2^{17}$): Rotation serial data = $32767*2^{17}$ When it is below the lower limit of reversal direction ($-32768*2^{17}$): Rotation Serial Data= $-32767*2^{17}$
TL	23		When it is higher than the upper limit value in the forward direction ($+32767*2^{23}$): Rotation serial data = $32767*2^{23}$ When it is below the lower limit of reversal direction ($-32768*2^{23}$): Rotation Serial Data= $-32767*2^{23}$

5.6.4 Read absolute position through communication

Basic parameters		
User parameter	Name	Use
U0-10	encoder feedback value	Absolute value single-turn position, read 0x100A and 0x100B hexadecimal address through Modbus RTU, $U0-10+ U0-11*10000$ is present encoder single-turn position
U0-11		
U0-91	present turns of multi-turn absolute	Read 0x105B hex address through ModbusRTU, which is the current number of encoder turns;
U0-57	absolute encoder present position feedback low 32-bit	Read 0x1039 hex address through ModbusRTU doubleword, which is the current encoder position, with positive and negative pulses;
U0-58		
U0-59	absolute encoder present position feedback high 32-bit	Read 0x103B hexadecimal address through ModbusRTU doubleword, which is the high bit of current encoder and needs to add the low bit data;
U0-60		

Servo driver transmits position data information of encoder through RS485 port and Modbus RTU protocol.

- 17-bit absolute value encoder has 131072 pulses per cycle.

First read the U0-60 (0x103C) value

(1) 0 means running in the positive direction. The current position of the encoder is $U0-57*1+U0-58*2^{16}$.

(2) -1 means running in the opposite direction. The current encoder value is:
 $(U0-57-65535)*1+(U0-58-65535)*2^{16}+(U0-59-65535)*2^{32}$.

If the position is read by XINJE HMI and the U0-57 (Modbus address is decimal 4153) double-word is read, the high-low byte exchange should be selected. If communicating with Xinje PLC, direct double-word reading is ok.

- 23-bit absolute value encoder, one-cycle pulse number is 8388608.
 First read the U0-60 (0x103C) value
 (1) 0 means running in the positive direction. The current encoder value is
 $U0-57*1+U0-58*2^{16}+U0-59*2^{32}$.
 (2) -1 means running in the opposite direction. The current encoder value is:
 $[(65536 - U0-57)* 1 + (65535-U0-58)* 2^{16} + (65535 - U0-59)* 2^{32}]*(-1)$.

Communication parameter description
 RS485 default communication parameters: baud rate 19200 bps; data bit 8; stop bit 1; even parity;
 Modbus station number 1.
 Note: Refer to Appendix 1 (P7-XX) for communication parameter description.

5.6.5 Reset absolute position

Parameters	Name
F1-06	Clear the turns of absolute encoder
U0-94	Relative encoder feedback value which can be reset
U0-95	
U0-96	
U0-97	

- F1-06 clear the turns

Encoder turns clearing should be done when servo driver is bb. The clearing methods include servo panel clearing and Modbus-RTU communication clearing. After the operation, U0-91 is 0, U0-57~U0-59 will change.

1. Servo panel clearing

Enter parameter F1-06 when servo is in bb state:



Press **【INC】** to 1, and keep press **【ENT】** to confirm and exit.

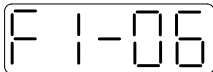

Clear the absolute encoder turns through F1-06 on the servo panel.

2. Modbus-RTU communication clearing

Write 1 to the Modbus address 0x2106 to clear the turns.

It will take effective when servo is in bb state, after clearing, write 0 in 0x2106.

- F1-06 zero position calibration

1. Calibrate through the servo panel

Enter F1-06 when servo is in bb status:



Press **【INC】** to 3 and long press **【ENT】** to confirm and exit.

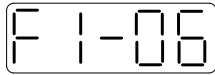

Calibrate the encoder current position as zero position through servo panel F1-06 parameter, U0-94~97 will show the encoder position after calibration.

2. ModbusRTU communication clearing

Write 3 to the modbus address 0x2106 (F1-06 parameter).

U0-94~U0-97 will display the motor absolute position after calibration.

5.7 Auxiliary functions

5.7.1 Anti-blocking protection

Anti-blocking alarm: When the motor speed is lower than P0-75 (unit 1 rpm) and the duration reaches the set value of P0-74 (unit ms), the current output torque U0-02 is greater than the internal positive torque limit of P3-28 and the internal reverse torque limit of P3-29, it will show the alarm E-165 blocking overtime.

■ Related parameters

Parameter	Meaning	Default setting	Unit	Range	Modify	Effective
P0-74	Blocking alarm time	According to models	1ms	0~65535	Anytime	At once
P0-75	Blocking alarm speed	50	rpm	5~9999	Anytime	At once
P3-28	Internal forward torque limit	300	%	0~300	Anytime	At once
P3-29	Internal reverse torque limit	300	%	0~300	Anytime	At once
P3-38	Anti-blocking alarm internal forward torque limit	300	%	0~300	Anytime	At once
P3-39	Anti-blocking alarm internal reverse torque limit	300	%	0~300	Anytime	At once

Note:

- (1) When P0-74 or P0-75 is set to 0, this alarm will not be detected;
- (2) If this alarm occurs during normal operation of servo, please confirm:
 - (a) Monitor U0-02 motor torque and check if P3-28 and P3-29 (P3-38/P3-39) torque limits are set properly;
 - (b) Check the external mechanical structure and installation;
- (3) P0-74 the default value of locked rotor alarm time is as follows:

Driver model	P0-74 (/ms) default parameter
DS5□-20P1-PTA	2000
DS5□-20P2-PTA	3000
DS5□-20P4-PTA	3000
DS5□-20P7-PTA	5000
DS5□-415P0-PTA	20000
Other models	0

P0-74 is 0, the anti-stall alarm is not opened by default, and users can configure it according to their own needs.

(4) Before firmware version U2-07 3760, the torque comparison value of anti-blocking alarm is P3-28/P3-29; after firmware version U2-07 3760, the torque comparison value of anti-blocking alarm is P3-38/P3-39.

(5) P3-38/P3-39 is only used as the comparison value of anti-blocking alarm (added after version 3760). P3-28/ P3-29 is the internal torque limit of the actual operation of the motor.

5.7.2 Torque limit

1. Internal torque limit

Parameter	Meaning	Default setting	Unit	Range	Modify	Effective
P3-28	Internal Forward torque limit	300	%	0~300	Anytime	At once
P3-29	Internal reverse torque limit	300	%	0~300	Anytime	At once

1. if this parameter value is less than external torque limit value, the final limit value is this parameter.
 2. The unit is percent of the motor rated torque; the default value is 300%. The real max output torque is limited by motor overload times.

2. External torque limit (via input signal)

Parameter	Meaning	Default setting	Unit	Range	Modify	Effective
P3-30	Forward external torque limit	300	%	0~300	Anytime	At once
P3-31	Reverse external torque limit	300	%	0~300	Anytime	At once

The unit is the percent of motor rated torque; the default value is 300%.

Parameter	Signal name	Default setting	Meaning	Range	Modify	Effective
P5-25	/P-CL	n.0000	The necessary condition to use forward external torque limit	Range 0000-001A, can be distributed to other input terminals through P5-25.	Anytime	At once
P5-26	/N-CL	n.0000	The necessary condition to use reverse external torque limit	Range 0000-001A, can be distributed to other input terminals through P5-26.	Anytime	At once

3. Relationship

The following are the relationship of internal torque limit, external torque limit, P-CL, /N-CL, T-REF.

T-REF distribution	P-CL/N-CL status	Final forward torque	Final reverse torque
0	0	Decided by P3-28	Decided by P3-29
	1	The smaller one of internal forward torque limit and external forward torque limit	The smaller one of internal reverse torque limit and external reverse torque limit
1	It doesn't work	Smaller value of internal forward torque limit and external analog torque	Smaller value of internal reverse torque limit and external analog torque
3	0	Decided by P3-28	Decided by P3-29
	1	Smaller value of internal forward torque limit and external analog torque	Smaller value of internal reverse torque limit and external analog torque

4. Output torque up to limit value signal

Parameter	Signal name	Default setting	Suitable mode	Meaning	Modify	Effective
P5-42	Torque limit /CLT	n.0000	All	Output signal when motor output torque up to P3-28, P3-29.	Anytime	At once

No terminals are assigned by default. The parameter range is 0000-0014, which is assigned to the output interface through parameter P5-42. When set to 0002, the signal is output from the SO2 terminal.

5.7.3 Speed limit

Parameter	Meaning	Default setting	Unit	Range	Modify	Effective
P3-14	Forward max speed command limit	4000	rpm	0~65535	Servo bb	At once
P3-15	Reverse max speed command limit	4000	rpm	0~65535	Servo bb	At once

Note: P3-14 and P3-15 are effective in all the modes.

5.7.4 I/O signal distribution

5.7.4.1 Input terminal distribution

1. Input signal distribution

Parameter	Parameter Meaning	Set value	Meaning
P5-20~P5-36	<p>Distribute input terminal no. 0: NO signal 1: NC signal Basic filter time No meaning</p>	n.0000	Not distribute to terminal input
		n.000x	Input always open signal from SIx
		n.0010	Set the signal to be always valid
		n.001x	Input always close signal from SIx

Note: The basic filtering time refers to input terminal filtering time.

2. default setting of input terminal

Input terminal	SI1	SI2	SI3	SI4
signal	/S-ON	/ALM-RST	/P-OT	/N-OT

3. Filtering time of input terminal

■ Related parameter

Parameter	Meaning	Default setting	Unit	Range	Modify	Effective
P5-18	SI filtering time multiple	1	-	0~10000	Anytime	At once

SI input filtering time is determined by IO parameter value and P5-18. Examples are as follows:

Pulse deviation clear set to SI1 terminal, and 30ms Filtering Time

The parameters are set as follows:

P5-34=n. 0 3 0 1

P5-34.0
P5-34.2

P5-34.0=1 input terminal is SII
 P5-34.2=3 basic filtering time is 3ms
 P5-18=10 filtering time multiple is 10
 So the total filtering time is P5-34.2 * P5-18=3ms*10=30ms

5.7.4.2 Output terminal distribution

1. Output signal distribution

Parameter	Parameter Meaning	Set value	Meaning
P5-37~P5-53		n.0000	Not distribute to terminal input
		n.000x	Output always open signal from SO _x
		n.0010	Set the signal to be always valid
		n.001x	output always close signal from SO _x

2. Default setting of output terminal

Output terminal	SO1	SO2	SO3
Signal	/COIN	/ALM	/S-RDY

5.7.5 Output terminal function

5.7.5.1 Servo ready output (/S-RDY)

■ Related parameter

Parameter	Meaning	Default setting	Unit	Range	Modify	Effective
P5-70	/S-RDY: output condition selection	1	-	0~1	Anytime	At once

Parameter	Signal name	Default setting	Suitable mode	Meaning	Modify	Effective
P5-41	/S-RDY	n.0003	All	servo ready output	Anytime	At once

Refer to section 3.2.2 for hardware wiring details.

P5-41 parameter setting range is n.0000-0014, which is assigned to other output terminals through parameters.

If it is necessary to output signal from SO2, P5-41 can be set to n.0002/0012.

Servo ready signal output conditions

When P5-70 is set to 0: after the driver initialization is completed and the servo has no alarm status /S-RDY is valid;

When P5-70 is set to 1: after enabling, the servo has no alarm status /S-RDY is valid.

5.7.5.2 Rotating detection output (/TGON)

1. Signal setting

Parameter	Signal	Default setting	Suitable mode	Meaning	Modify	effective
P5-40	/TGON	n.0000	All	Rotating detection output	Anytime	At once

It is the output signal indicating that the servo motor is rotating at a speed higher than the set value.

1. No terminal output signal is assigned by default. The parameter range is 0000-0018, which is

allocated to other output terminals through parameter P5-40.

2. When the speed of the servo motor is higher than the set value of P5-03, the signal that the servo is rotating is considered.

2. Related parameters

Parameter	Meaning	Default value	Unit	Range	Modify	Effective
P5-03	Rotating detection speed /TGON	50	rpm	0~10000	Anytime	At once

If the speed of the servo motor exceeds the set value of P5-03, it is judged that the servo motor is rotating and the output of the rotation detection (/TGON) signal.

Note: Rotation detection has a hysteresis of 10 rpm.

3. Hysteresis

Hysteresis is set up to prevent the system from repeatedly acting and oscillating when the parameters fluctuate up and down in a certain value. Once the hysteresis value is set, there will be a fixed ring width. Then only when the parameter must be greater than a certain value can the action be taken. When the parameter is smaller than another value, the action will be released. The ring width determines the interval time of the action. The action of small ring width is sensitive and frequent, and the action of large ring width is slow.

It should be noted that the rotation detection speed (P5-03), the same speed detection speed (P5-04), the arrival detection speed (P5-05), all contain 10 rpm hysteresis. For example, the rotation detection speed P5-03 is set to 50, and the rotation detection/TGON output port is SO3.

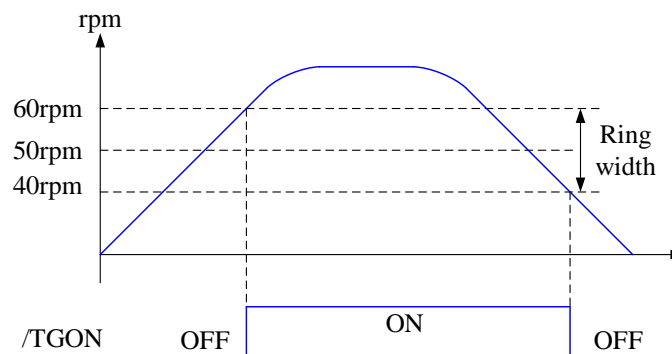

5.7.5.3 Same speed detection (/V-CMP)

Parameter	Signal	Default setting	Suitable mode	Meaning	Modify	Effective
P5-39	/V-CMP	n.0000	3, 4, 7	Same speed detection	Anytime	At once

Defaulted is not distribute to the terminals. Range: 0000-0018. Distribute to output terminal through P5-39. When it set to 0002, it means output from SO2.

Parameter	Meaning	Default setting	Unit	Range	Modify	Effective
P5-04	Same speed detection signal width	50	rpm	0~10000	Anytime	At once

There is default 10rpm hysteresis loop, please refer to chapter 5-12-3 for hysteresis loop.

5.7.5.4 Warn output (/WARN)

Set the alarm output threshold, when the current speed is higher than the warning speed, output /WARN.

Parameter	Meaning	Default value	Unit	Range	Modify	Effective
P3-19	Forward warning speed	Motor related	rpm	0~65535	Servo bb	At once
P3-20	Reverse warning speed	Motor related	rpm	0~65535	Servo bb	At once

Parameter	Signal	Default setting	Suitable mode	Meaning	Modify	effective
P5-45	/WARN	n.0000	All	Warning output	Anytime	At once

1. No terminal output signal is assigned by default. The parameter range is 0000-0018, which is allocated to other output terminals through parameter P5-45.

2. When a warning occurs, the servo unit only outputs the warning and will not be forced to set OFF.

5.7.5.5 Alarm output (/ALM)

1. Servo alarm output /ALM

Parameter	Signal name	Setting	Meaning	Range
P5-47	Alarm output /ALM	n.0002 (default)	When the servo alarm, SO2 and COM are connected, and the alarm signal is output.	The parameter range is 0000-0018, which is assigned to the output interface by parameter P5-47. When set to 0001, the signal is output from the SO1 terminal.
		n.0012	When the servo alarm, the SO2 and COM are switched off.	

Note:

(1) When an alarm occurs, the servo unit is forced to set OFF, and the motor will move with external forces (including gravity). If you need to keep the motor in position, please select the motor with power loss brake (also known as brake) and use /BK signal. Refer to Section 5.2.5.

(2) The output of the functional parameters can not be repeated.

5.7.5.6 Encoder Z phase output (/Z)

parameter	Meaning	Default setting	Unit	Range	Modify	Effective
P5-48	Z phase output /Z	n.0000	-	0000~0018	Anytime	At once
P5-19	Z phase pulse width	2	ms	2~20	Anytime	At once

1. /Z signal can be distributed to the output terminal through P5-48.

2. Z phase signal is single pulse output mode, the default pulse width is 2ms, it can set through P5-19, it is not related to the motor speed.

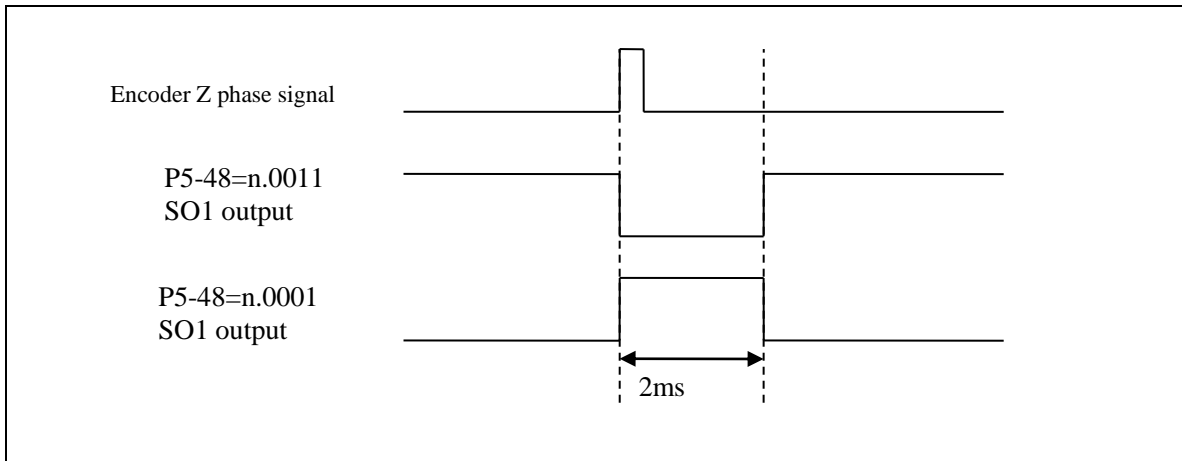

5.7.5.7 User-defined output signal

User can define 2 outputs. The defined method is SOx output when $A > B$ or $A < B$. A is 9 activating conditions; B is user-defined comparison value.

User-defined output 1:

P5-10	The trigger condition of user-defined output 1						
	Default trigger condition	Trigger condition setting	Unit	Suitable mode	Change	effective	
	0	See below table: optional trigger condition	Related to trigger condition	All the modes	Anytime	At once	
P5-11	The comparison value for the trigger condition of user-defined output 1						
	Unit	Default setting	Range	Suitable mode	Change	Effective	
	Related to trigger condition	0	-32768~32767	All the modes	Anytime	At once	
P5-12	When $P5-10 \geq P5-11$ or $P5-10 < P5-11$, SOx output						
	Setting value	Function		Default value	Suitable mode	Change	Effective
	0	$P5-10 \geq P5-11$, SOx output		0	All the modes	Anytime	At once
	1	$P5-10 < P5-11$, SOx output					
2	P5-10 absolute value $\geq P5-11$, SOx output						
3	P5-10 absolute value $\leq P5-11$, SOx output						
P5-13	User-defined output 1 hysteresis loop						
	Unit	Default setting	Range	Suitable mode	Change	Effective	
	Related to trigger condition	0	0~65535	All the modes	Anytime	At once	
P5-52	Output terminal setting of user-defined output 1						
	Signal name	Default setting	Meaning	Change			
	User-defined output 1	n.0000	Default setting is not distribute to the output terminal	Range 0000-0018, distribute to the output terminal through P5-52.			

User-defined output 2:

P5-14	The trigger condition of user-defined output 2					
	Default trigger condition	Trigger condition setting	Unit	Suitable mode	Change	Effective
	0	See below table: optional trigger condition	Related to trigger condition	All the modes	Anytime	At once
P5-15	The comparison value for the trigger condition of user-defined output 2					
	Unit	Default setting	Range	Suitable mode	Change	Effective
	Related to trigger condition	0	-9999~9999	All the modes	Anytime	At once
P5-16	When P5-14 \geq P5-15 or P5-14<P5-15, SOx output					
	Setting value	Function	Default setting	Suitable mode	Change	Effective
	0	P5-14 \geq P5-15, SOx output	0	All the modes	Anytime	At once
	1	P5-14<P5-15, SOx output				
2	P5-14 absolute value \geq P5-15, SOx output					
3	P5-14 absolute value < P5-15, SOx output					
P5-17	User-defined output 2 hysteresis loop					
	Unit	Default setting	Range	Suitable mode	Change	Effective
	Related to trigger condition	0	-32768~32767	All the modes	Anytime	At once
P5-53	Output terminal setting of user-defined output 2					
	Signal name	Default setting	Meaning	Change		
	User-defined output 2	n.0000	Default setting is not distribute to the output terminal	Range 0000-001A, distribute to the output terminal through P5-53		

Note: please refer to chapter 5-12-3 for hysteresis loop.

Optional trigger conditions:

Condition no.	Meaning	Unit
0	-	-
203	Current command	Rated current %
205	Current feedback	Rated current %
301	Speed command	rpm
302	Speed feedback	rpm
308	Speed deviation	rpm
4402	Position command	1 command
4404	Position feedback	1 command
1406	Position deviation	1 command
502	Bus voltage	V
503	Drive internal temperature	°C
506	Average output power	W
508	Average thermal power	W

5.7.5.8 Other SO terminal function

Terminal name	Description	Chapter
/COIN-HD	Positioning completion hold	5.3.1.2
/COIN	Positioning end	5.3.1.2
/CLT	Torque limit detection	5.8.2
/VLT	Speed limit detection	5.5.1.3
/MRUN	Internal position mode motion start	5.3.2.7
/V-RDY	Speed arriving signal	5.4.1.3
/PREFA	Internal position selection signal	5.3.2.1
/PREFB	Internal position selection signal	5.3.2.1
/PREFC	Internal position selection signal	5.3.2.1
/PREFD	Internal position selection signal	5.3.2.1

5.7.6 Input terminal function

5.7.6.1 Proportion action command (/P-CON)

Parameter	Signal	Type	Default	State	Meaning	Modify	Effective
P5-21	/P-CON	Input	n.0000	Valid	Run in P control mode	Anytime	At once
				Invalid	Run in PI control mode		
<ol style="list-style-type: none"> 1. /P-CON is the speed control mode signal selected from PI (proportion integral) and P (proportion). 2. If set to P control mode, the motor rotate and micro-vibration caused by speed command input drift can be decreased. But the servo stiffness will decrease. 3. /P-CON signal can be distributed to input terminal via parameter P5-21. 							

5.7.6.2 Alarm reset (/ALM-RST)

■ Alarm reset /ALM-RST

Parameter	Signal	Default setting	Suitable mode	Meaning	Modify	effective
P5-24	/ALM-RST	n.0002	All	Input normally open signal from SI2 terminal	Anytime	At once
<ol style="list-style-type: none"> 1. The parameter range is 0000-001A, which is allocated to other input terminals through parameter P5-24. 2. When an alarm occurs, find out the cause of the alarm and remove it, then clear the alarm by setting the signal to be effective. 3. /ALM-RST signal can be assigned to other terminals through this parameter, because the alarm signal is related to the safe operation of the servo, so the /ALM-RST signal can not be set to be always valid (n.0010). 						

5.7.6.3 Other SI terminal function

Terminal name	Description	Chapter
/S-ON	Servo enable	5.2.2
/P-OT	No forward driving	5.2.4
/N-OT	No reverse driving	5.2.4
/P-CL	Forward side external torque limit	5.8.2
/N-CL	Reverse side external torque limit	5.8.2
/SPD-D	Internal speed direction	5.4.2
/SPD-A	Internal setting speed	5.4.2
	Position mode reference origin triggering	5.3.1.8
/SPD-B	Internal setting speed	5.4.2
	Position mode reference origin triggering	5.3.1.8
/C-SEL	Control mode selection	5.1.2
/ZCLAMP	Zero clamp	5.4.1.2
/INHIBIT	Command pulse inhibit	5.3.3.4

5.7.7 Time limit curve of overload protection

The time limit curve of overload protection is only used for the judgment of alarm output and the protection of overload operation. It is recommended to use it within the continuous operation stage of torque speed curve. For the torque speed curve, please refer to appendix 9.

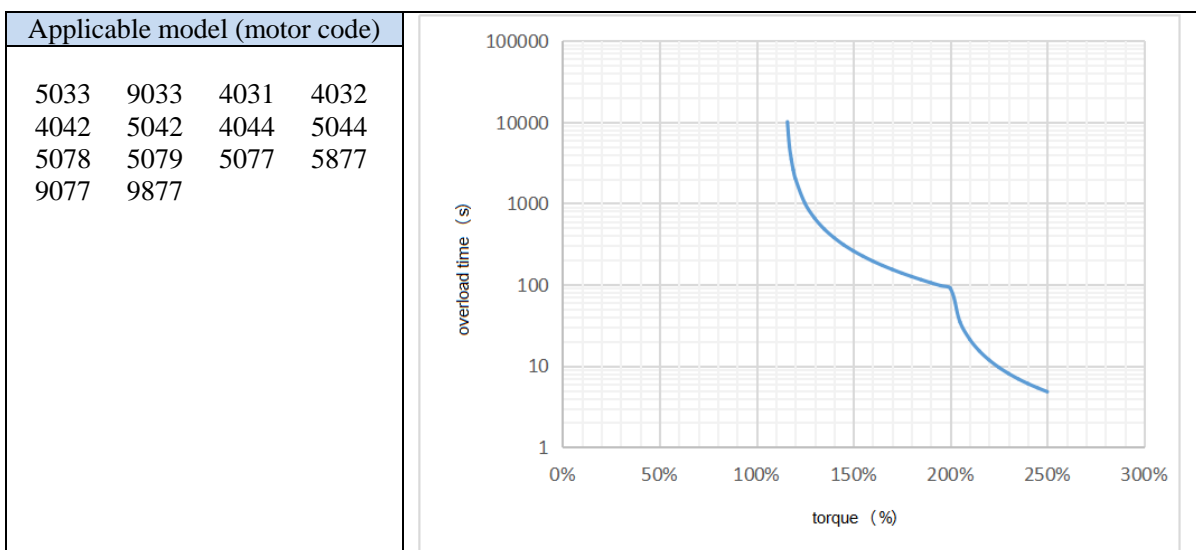
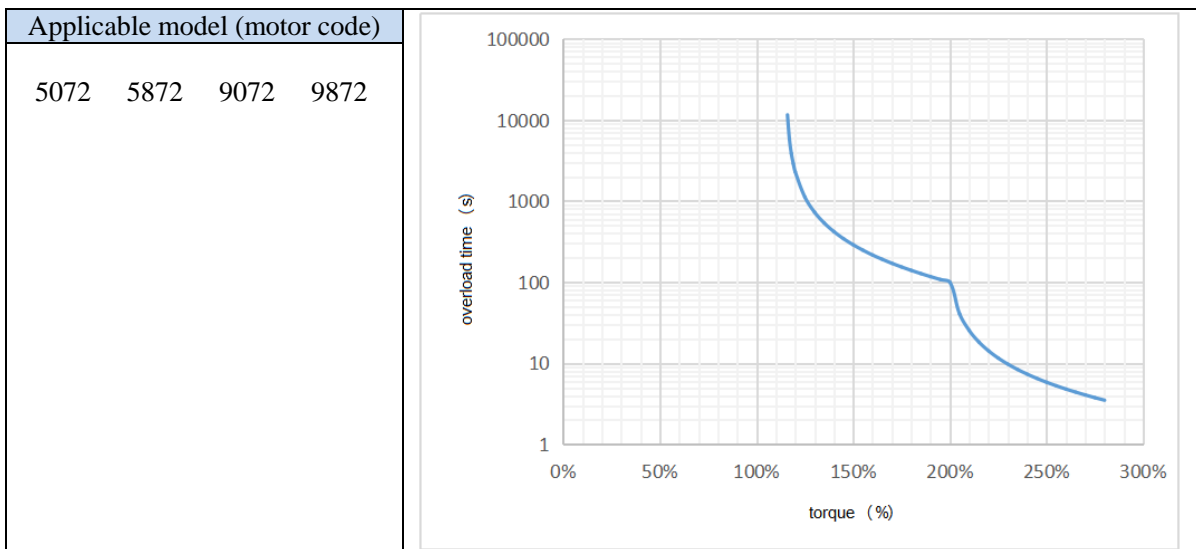
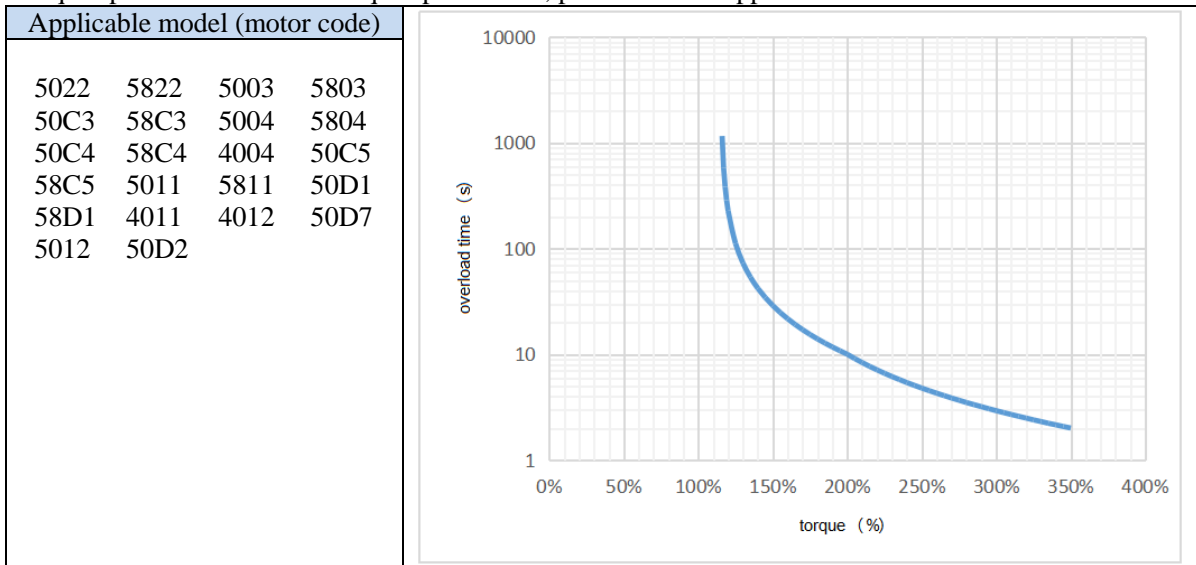

Applicable model (motor code)			
5174	9174	5974	9974
9148	9045		

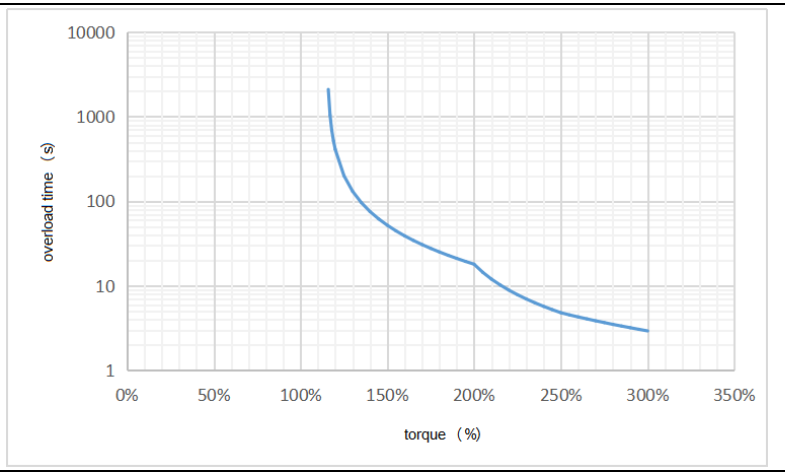

Applicable model (motor code)			
5175	9175	5975	9975
9166	916A	916B	

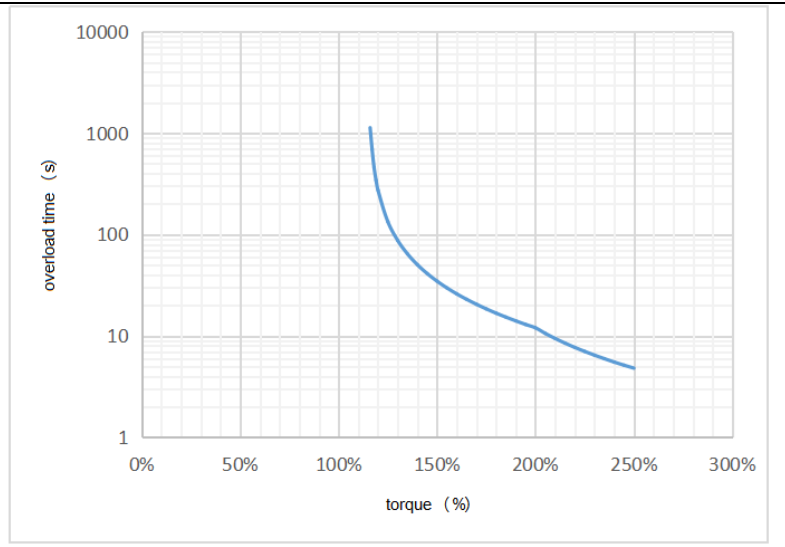

Applicable model (motor code)			
5034	9034	5074	5874
9074	9874	9037	5037
5046	4046	9046	5075
5875	9075	9875	404B
9161	9162	9163	

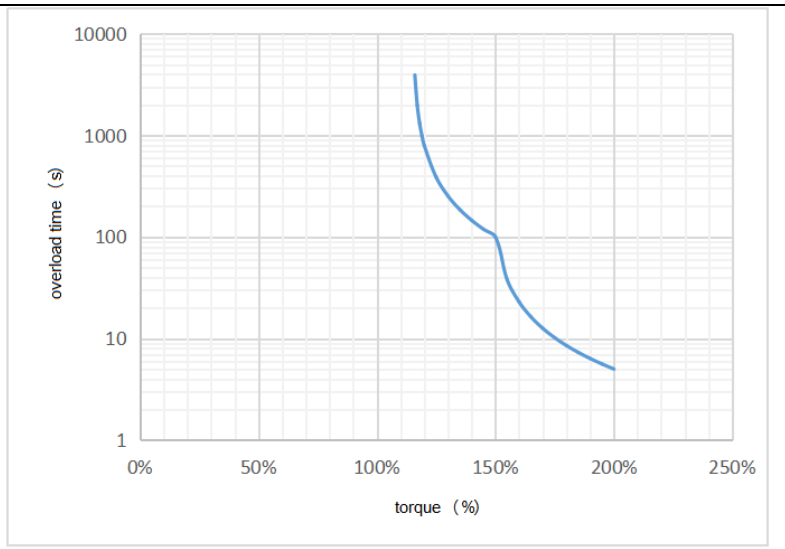

5.8 Encoder ABZ phase frequency division output

The servo driver outputs the differential signal through the frequency division output circuit. It can provide position signal for the control of the upper computer or pulse signal for the driven servo, so as to realize the follow-up control of the master-slave shaft.

1. Encoder frequency division output specification

Terminal name	Terminal pin no.		Terminal function
	Hardware version 3131 and earlier [CN1]	Hardware version 3131 and later [CN0]	
OA+	1	35	A phase frequency division output
OA-	2	36	
OB+	3	37	B phase frequency division output
OB-	4	38	
OZ+	5	39	Z phase frequency division output
OZ-	9	40	

2. Wiring diagram

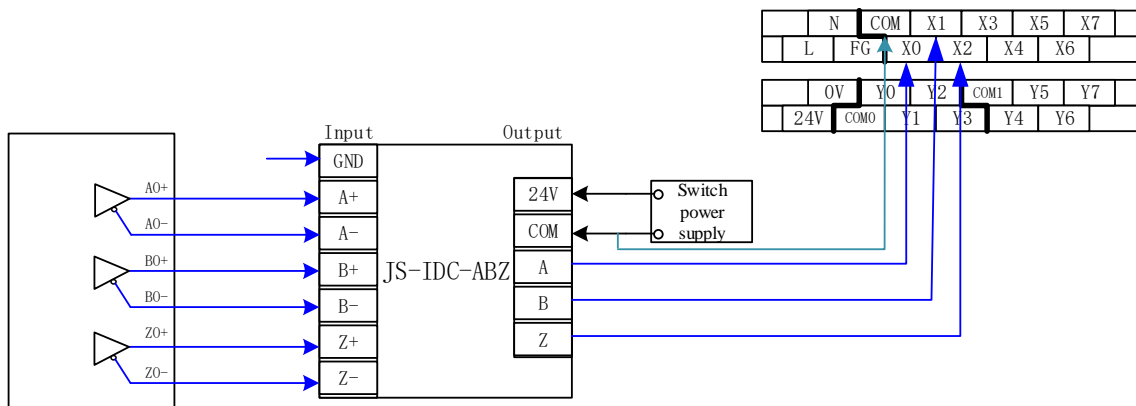

3. Encoder feedback pulse number per turn

P0-18	Set the number of feedback pulses per turn of encoder (low-order position)					
	Unit	Default setting	Range	Suitable mode	Modify	Effective
	1	0	0~9999	All	Servo OFF	At once
P0-19	Set the number of feedback pulses per turn of encoder (high-order position)					
	Unit	Default setting	Range	Suitable mode	Modify	Effective
	10000	1	0~9999	All	Servo OFF	At once

Note:

(1) Output pulses per turn: P0-19 * 10000 + P0-18. It can be any positive integer.

(2) Encoder feedback will be output from CN0 port (hardware version 3131 and earlier encoder feedback output at CN1 port). It is recommended that the lower computer accept pulse with AB phase counter.

If AB phase counting is adopted, the counting value of motor rotation for one turn is 4 times of the set pulse number per turn of encoder (P0-18 + P0-19 * 10000).

(3) The pulse output frequency of each phase shall not exceed 1MHz, and the number of pulses per cycle can be set in cooperation with the z-phase pulse estimation formula.

Example: Assume the actual speed of motor is 3000rpm,

$$\frac{28.8}{3000 \times \text{ppr}} \times 2 \geq \frac{1}{10^6} \Rightarrow \text{ppr} \leq 18720$$

, then

the setting of pulse number feedback per turn shall not exceed 18720.

$$\frac{1}{\frac{n}{60} \times \text{ppr}} \geq \frac{1}{10^6} \Rightarrow \text{ppr} \leq 20000$$

, then

the setting of pulse number feedback per turn shall not exceed 20000.

(4) Assuming that the number of feedback pulses per turn is 10, the output signals of phase A (PAO)

and phase B (PBO) are as follows:

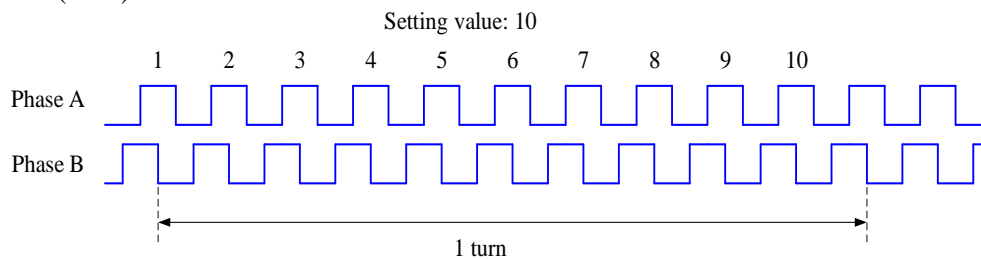

P0-87.1	Encoder feedback output direction selection					
	Setting value	Function	Default value	Suitable mode	Modify	Effective
	0	forward operation when phase A ahead phase B	0	All	Servo OFF	At once
1	Reverse operation when phase B ahead phase A					
forward operation when phase A ahead phase B			forward operation when phase A behind phase B			
P0-87.0	Differential feedback output phase Z mode					
	Setting value	Function	Default value	Suitable mode	Modify	Effective
	0	Only forward output encoder frequency division z-phase pulse	1	All	Servo OFF	At once
1	Both forward and reverse directions output encoder frequency division z-phase pulse					
Phase Z pulse width	Pulse output frequency below 50kHz (unit: s)			Pulse output frequency above 50kHz (unit: s)		
	$\frac{1}{\frac{n}{60} \times ppr} \div 2$			$\frac{28.08}{n \times ppr}$		

N: speed, unit: rpm;

Ppr: P0-19*10000 + P0-18, unit: pulse

The above formula is only for estimation.

5.9 Full closed-loop input

The full closed-loop system is a system which is installed on the moving machine by the external position detection device (such as encoder, grating ruler, etc.) to detect the position of the control object and feedback the machine position information to the servo unit in real time. The full closed-loop control mode can ensure that the external machinery has no deviation and improve the control accuracy. At present, the full closed-loop function supports all control modes.

Speed command

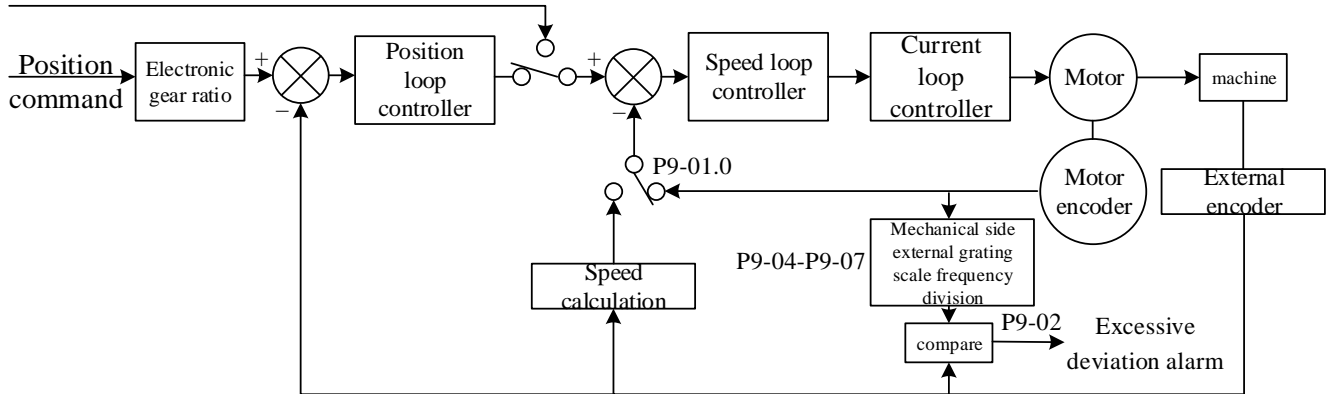

When the full closed-loop is opened, the external grating ruler position feedback is used; when the full closed-loop speed feedback is opened, the external grating ruler speed feedback is used. When the full closed-loop mode is on, the control mode can be switched (P0-01 and P0-02).

5.9.1 Full closed-loop input specification

DS5F series servo hardware version 3131 (not included) and later supports the function of full closed-loop input.

Terminal name	Terminal number	Terminal function
A+	4	Full closed loop input phase A
A-	5	
B+	3	Full closed loop input phase B
B-	2	
Z+	9	Full closed loop input phase Z
Z-	1	
GND	6/7	Grating scale signal ground
5V	8	Grating ruler power supply 5V

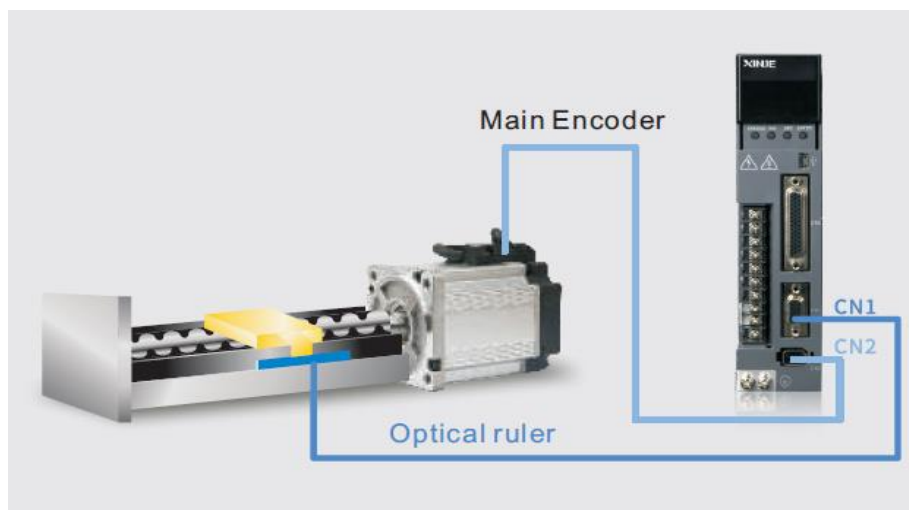

5.9.2 Full closed-loop mode operation steps

(1) Confirm the action under the half closed-loop system when operating without load.

Under no-load state of servo motor, trial operation and inching operation are performed, refer to group F1 operation in chapter 4.4.2, set initial control parameters after confirming that there is no error, and then send instructions through upper device to ensure normal operation in semi closed loop control mode (P9-00.0 = 0).

■ Related parameters

Parameter	Meaning	Default setting	Unit	Range	Modify	Effective
P0-01	Control mode selection	0	-	0~1	Anytime	At once
P0-09.0 n.xxx□	Pulse command forward direction	0	-	0/1	Servo bb	Re-power on
P0-11	Pulse number per turn *1	0	pul	0~9999	Servo bb	At once
P0-12	Pulse number per turn*10000	1	pul	0~9999	Servo bb	At once
P0-13	Electronic gear ratio (numerator)	1	-	0~65535	Servo bb	At once
P0-14	Electronic gear ratio (denominator)	1	-	0~65535	Servo bb	At once
P0-92	Second group of electronic gear ratio low bit (numerator) *1	1	-	1~9999	Servo bb	At once
P0-93	Second group of electronic gear ratio high bit (numerator) *10000	0	-	1~65535	Servo bb	At once
P0-94	Second group of electronic gear ratio low bit (denominator) *1	1	-	1~9999	Servo bb	At once
P0-95	Second group of electronic gear ratio high bit (denominator) *10000	0	-	1~65535	Servo bb	At once

(2) In the state of servo motor and mechanical connection, confirm the action of half closed-loop control.

After connecting with the relevant mechanical structure, the load inertia ratio shall be estimated first (refer to 6.3.4 operation steps). Then use the upper device to send the command to the servo, and confirm that the connection of the mechanism is correct and the operation is normal.

■ Related parameters

Parameter	Meaning	Default setting	Unit	Range	Modify	Effective
P0-07	first inertia ratio	200	%	0~50000	Anytime	At once

(3) Correctly import the external encoder (grating ruler) signal.

Open the full closed-loop function (P9-00.0=1), and set the relevant parameters of the full closed-loop function. When the motor is not enabled, manually operate the machine, compare the original data of grating ruler (U4-11/12) in the full closed-loop mode with the original data of motor encoder (U0-11/10), install the grating ruler correctly or adjust the counting direction of grating ruler through P9-00.1.

■ Related parameter

Refer to chapter 5.9.3.

(4) Under the full closed-loop control mode (P9-00.0=1), do F1-00 inching operation to confirm the normal operation of the system.

Jog the servo motor (panel F1-00 or upper computer, the speed changes from slow to fast, observe whether there is any abnormality in operation)

■ Related parameter

Parameter	Meaning	Default setting	Unit	Range	Modify	Effective
P3-18	JOG speed	100	1rpm	0~1000	Servo bb	At once

P3-18 is the speed configured for closed-loop inching operation, which only takes effect in two inching modes, and the rest normal control modes are invalid.

(5) Run the servo system and confirm whether the full closed-loop system operates normally.

Send instructions through PLC and other upper devices to observe the operation of the servo unit. Slowly increase from low speed to target speed and gradually confirm.

5.9.3 Full closed-loop control parameter

5.9.3.1 Full closed-loop function switch

Parameter	Setting	Function	Default setting	Range	Modify	Effective
P9-00	n.xxx□	Full closed loop control mode switch	0	0~1	Servo bb	Re-power on

When the parameter is set to 0, the full closed-loop function is closed; when the parameter is set to 1, the full closed-loop function is opened, and the external encoder position signal is used for control.

Only when P9-00.0 full closed-loop function is opened, other related functions of P9-00 and P9-01 can work, otherwise, even the setting will be invalid. The opening of the full closed-loop function requires the servo to be powered on again.

5.9.3.2 Counting direction and type selection of grating ruler

Parameter	Setting	Function	Default setting	Range	Modify	Effective
P9-00	n.xx□x	Counting direction of grating ruler	0	use the grating ruler counting value directly	Servo bb	Re-power on
			1	Grating ruler counting value reversed		

P9-00 shall cooperate with motor rotation direction parameter setting (P0-05) to decide whether to change.

When the direction setting is wrong, when P9-02 is not set to 0, the alarm E-236 (alarm of excessive deviation between motor and load position) will be output during operation, at this time, shutting down the enable needs to be powered on again; if P9-02 is 0, the alarm E-237 (counter direction reversed) will be output, and the value will be adjusted by power on again.

Parameter	Setting	Function	Default setting	Range	Modify	Effective
P9-00	n.x□xx	Grating ruler type	0	Phase AB counting	Servo bb	Re-power on
			1	Incremental serial communication		
			2	Absolute serial communication		

5.9.3.3 Speed feedback selection and servo pulse output mode in full closed loop control

Parameter	Function	Unit	Default setting	Suitable mode	Modify	Effective
P9-01		—	n.0000	All	Servo bb	Re-power on
	Setting	Function	Default setting	Range		
	n.□xxx	No meaning				
	n.x□xx	Servo pulse output	0	0~1		
	n.xx□x	Z-phase signal source	0	0~1		
n.xxx□	Speed feedback selection in full closed loop control		0	0~1		

1. Speed feedback selection in full closed loop control

n.xxx□	Meaning
0	use motor encoder speed
1	use grating ruler speed

Full closed loop control is usually set to "use motor encoder speed (P9-01.0 = 0)". When connecting only the direct driving servo motor and the high-resolution grating ruler, please set it to "use grating ruler speed (P9-01.0 = 1)".

2. Z-phase signal source

n.xx□x	Meaning
0	motor encoder phase Z
1	grating ruler phase Z

P9-01.1 determines the z-phase source of the return to zero process.

3. Servo pulse output

n.x□xx	Meaning
0	Motor encoder phase ABZ output
1	Grating ruler ABZ output waiting for positioning completion

P9-01.2 determines the signal source of servo pulse output.

5.9.3.4 Frequency division setting of mechanical side grating ruler

parameter	Meaning	Default setting	Unit	Range	Modify	Effective
P9-05	Motor encoder feedback pulses per turn /Low	0	PULSE	0~9999	Servo bb	Re-power on
P9-06	Motor encoder feedback pulses per turn /High	0	PULSE	0~9999	Servo bb	Re-power on
P9-07	Grating ruler feedback pulses per turn /Low	0	PULSE	0~9999	Servo bb	Re-power on
P9-08	Grating ruler feedback pulses per turn /High	1	PULSE	0~9999	Servo bb	Re-power on

1. Mechanical side grating scale frequency division

$$= \frac{\text{Motor encoder feedback pulse per turn}}{\text{External quadrature encoder pulse per turn}}$$

$$= \frac{P9-06*10000+P9-05}{P9-08*10000+P9-07}$$

Motor encoder feedback pulse per turn = P9-06*10000+ P9-05. When the set value = 0, the resolution of the encoder is set to the frequency division numerator.

Grating ruler feedback pulse per turn = P9-08*10000+ P9-07, P9-08*10000+ P9-07. When the setting value = 0, set 10000 as the frequency division denominator.

Input the frequency division ratio of external grating ruler completely, cannot input it after reducible division.

2. In the full closed-loop mode, it is recommended that P0-11 and P0-12 be set to 0, and the electronic gear ratio of P0-13 and P0-14 is adopted. P0-11 and P0-12 can also be used on the premise that the frequency division of external grating ruler is correct, otherwise, E-236 will be alarmed.

5.9.3.5 Alarm detection and clearing

parameter	Meaning	Default setting	Unit	Range	Modify	Effective
P9-02	Alarm value of excessive deviation between motor and load position	100	PULSE	0~65535	Servo bb	At once

① P9-02 deviation setting of encoder feedback (position) and full closed-loop grating scale feedback (load position).

If the set value is exceeded, reset is required by turning off enable when it output E-236.

When P9-02 is set to 0, it will not alarm, but when the motor encoder signal and grating scale signal count in the opposite direction, it will alarm E-237, and restore by reset and adjusting P9-00.1.

② In order to prevent the motor from running away and damaging due to the damage of external grating ruler or loose wiring, please set P9-02 to the appropriate value.

③ P9-02 is set according to the resolution of grating ruler.

Parameter	Meaning	Default setting	Unit	Range	Modify	Effective
P9-03	Motor load position deviation clearing setting	0	turn	0~65535	Servo bb	At once

① When P9-03 motor rotates N cycles in one direction, the recorded value of the difference between the motor encoder feedback (position) and the full closed-loop grating scale feedback (load position) will be cleared and counted again from zero.

② If it is set to 0, the motor load position deviation will not be cleared. If it is set to a non-zero value, the motor load position deviation will be cleared after the motor has accumulated N revolutions.

Parameter	Meaning	Default setting	Unit	Range	Modify	Effective
P9-04	Motor load speed deviation too large alarm value	100	RPM	0~65535	Servo OFF	At once

No alarm when this parameter is set to 0.

P9-04 is the deviation between motor encoder speed feedback and full closed-loop grating scale speed feedback. If the actual deviation exceeds the set value, the alarm E-238 will happen, only valid when the full closed-loop speed feedback P9-01.0 is open.

5.9.3.6 Monitoring parameters in full closed loop mode

In the full closed-loop mode, the motor encoder data in the original control loop is replaced by the grating scale feedback position data (except for the mechanical angle feedback in the current loop).

Parameter	Meaning	Data
U4-11	Grating ruler raw data	U4-12*10000+ U4-11
U4-12		
U4-13	Original z-phase number of grating ruler	-
U4-14	Grating ruler motion feedback data	U4-15*10000+ U4-14
U4-15		

5.9.3.7 Sampling channel of full closed loop control

When the grating speed feedback is enabled, the feedback speed information of the motor encoder will also be replaced by the grating speed data. That is to say, the same channel sampling results in grating scale feedback information.

Sampling channel	Sampling function
1950	Original position information of grating ruler
1951	The difference position feedback of grating scale calculated by twice data
1952	The difference position data of grating ruler feedback by ENC module
0953	Differential position feedback of grating scale obtained from data calculation under the resolution of motor encoder
0954	When the full closed-loop speed feedback is on, the grating scale speed feedback [Norm]
0955	The error between the position feedback of the motor encoder and the difference value of the position feedback of the grating ruler under the resolution of the grating ruler
0956	Error accumulation value between position feedback of motor encoder and difference value of position feedback of grating ruler under the resolution of grating ruler
1957	Error accumulation value between motor encoder feedback and grating ruler position feedback difference value under user command resolution
4958	Motor encoder feedback for clearing error per n turns
4959	The original feedback of motor encoder in grating resolution
0960	Speed feedback of motor encoder under full closed loop [Norm] (corresponding to 0954)

6 Servo gain adjustment

6.1 Overview of servo gain adjustment

6.1.1 Overview and process

The servo driver needs to drive the motor as fast and accurately as possible to track the instructions from the upper computer or internal settings. In order to meet this requirement, the servo gain must be adjusted reasonably.

Servo gain factory value is adaptive mode, but different machines have different requirements for servo responsiveness; the following figure is the basic process of gain adjustment, please adjust according to the current machine status and operation conditions.

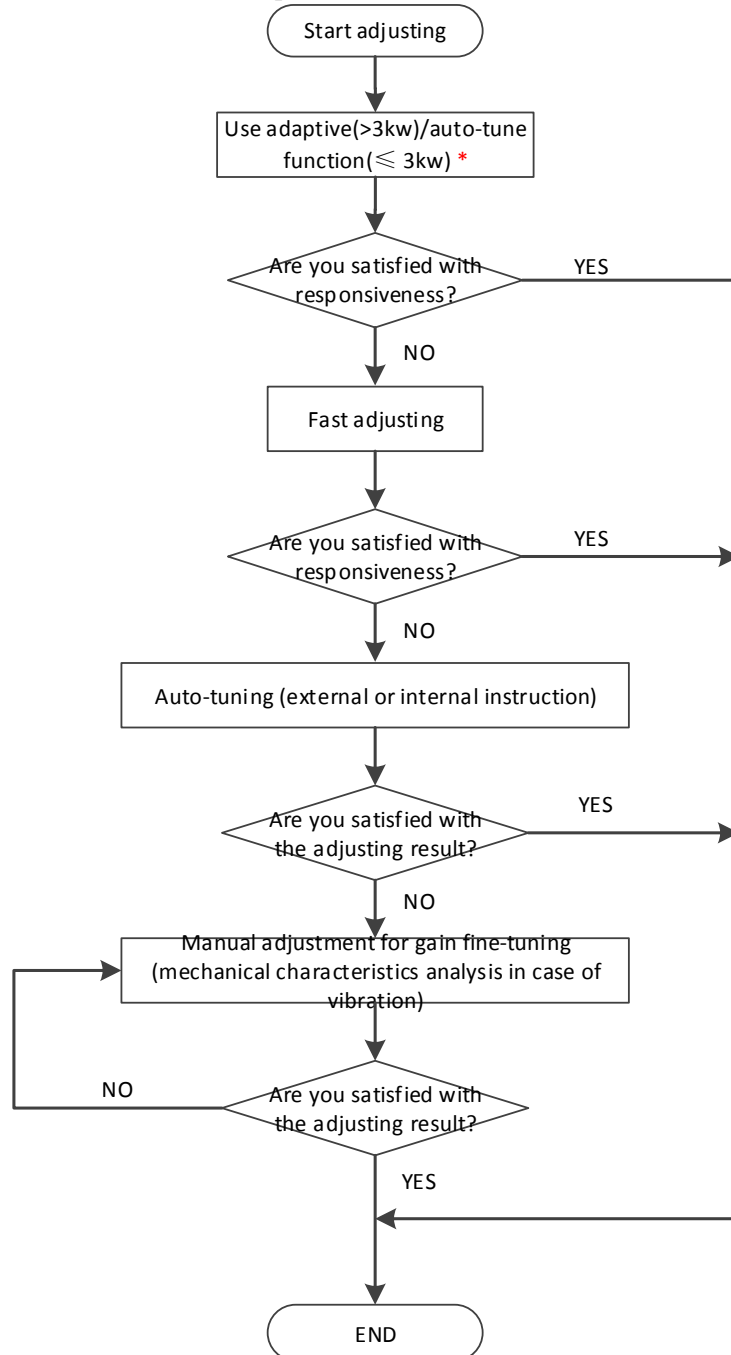

Note: * marked as version 3730, the version before 3730 is in adaptive mode when out of factory.

6.1.2 The difference of these adjustment modes

Adjustment modes are divided into adaptive and auto-tuning, and their control algorithms and parameters are independent. Among them, the auto-tuning mode is divided into three functions: fast adjustment, automatic adjustment and manual adjustment. The three functions are the same in essence but different in implementation. Refer to the corresponding chapters of each function.

Mode	Type	Parameters	Rigidity	Responsiveness	Related parameters
Adaptive	Automatic adaptation	P2-01.0=1	middle	150ms	P2-05 adaptive speed loop gain P2-10 adaptive speed loop integral P2-11 adaptive position loop gain P2-07 adaptive inertia ratio P2-08 adaptive speed observer gain P2-12 adaptive stable max inertia ratio
Auto-tuning	Fast adjusting	P2-01.0=0	high	10~50ms	P0-07 first inertia ratio P1-00 speed loop gain P1-01 speed loop integral P1-02 position loop gain P2-35 Torque instruction filtering time constant 1 P2-49 Model loop gain
	Automatic adjustment		high	10ms	
	Manual adjusting		high	Determined by parameters	

6.1.3 Model loop control

In the auto-tuning mode, besides the gain of speed loop and position loop, there is also the gain of model loop, which has a great influence on the servo responsiveness. When the model loop is not open, the servo responsiveness is determined by the gain of the position loop, and when the model loop is open, the servo responsiveness is determined by the gain of the model loop. The model loop is equivalent to feed-forward function in the driver control loop, and its specific function refers to chapter 6.5 manual adjustment.

When the auto-tuning mode is soft, the function of the model loop will automatically turn off; when the auto-tuning mode is fast positioning or fast positioning (control overshoot), the function of the model loop will automatically turn on.

Auto-tuning mode

Parameter	Meaning	Default setting	Modification	Effective	
P2-02	n.□□□1	Soft	n.□□□3	At anytime	at once
	n.□□□2	Fast positioning			
	n.□□□3	fast positioning (control overshoot)			

Selection of auto-tuning mode:

① Soft (P2-02.0 = 1):

This method does not turn on the gain of the model ring, and is suitable for the occasion of insufficient mechanical rigidity and low response requirements.

② Fast positioning (P2-02.0 = 2):

In this way, the response of setting parameters is the fastest, but there is no special suppression to overshoot.

③ Fast positioning (control overshoot) (P2-02.0 = 3):

In this way, the response of setting parameters is fast, and the overshoot is restrained.

Load type	Explanation
Synchronous belt	The adjustment is suitable for the mechanism with lower rigidity such as synchronous belt mechanism.
Lead screw	It is suitable for the adjustment of high rigidity mechanism such as ball screw mechanism. Please select this type when there is no corresponding structure.
Rigid connection	The adjustment is suitable for rigid body system and other mechanisms with high rigidity.

Auto-tune mode	Explanation
Soft	Soft gain adjustment. In addition to gain adjustment, the notch filter is also adjusted automatically
Fast positioning	Make special adjustment for positioning purpose. In addition to gain adjustment, the model loop gain and notch filter are also adjusted automatically
fast positioning (control overshoot)	Pay attention to the adjustment of no overshoot in the positioning purpose. In addition to gain adjustment, the model loop gain and notch filter are also adjusted automatically

Model loop function

Parameter	Meaning	Default setting	Modification	Effective	
P2-47	n.□□□0	Model loop turn off	n.□□□0	At anytime	At once
	n.□□□1	Model loop turn on			

Taking DS5 series servo auto-tuning mode and using 750W servo 5 times load inertia as an example:

■ Model loop function turns off (soft mode)

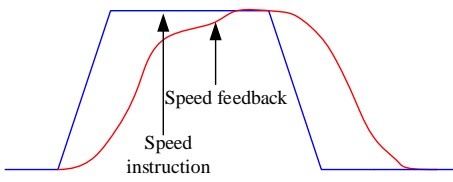
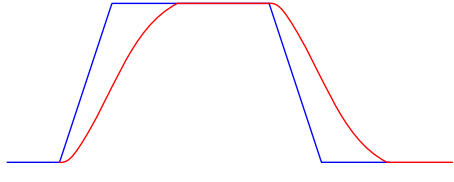
Low Rigidity and Low Response	High Rigidity and Medium Response
	
Load inertia ratio P0-07: 500%	
speed loop gain P1-00: 200	speed loop gain P1-00: 800
speed loop integral P1-01: 3300	speed loop integral P1-01: 825
position loop gain P1-02: 200	position loop gain P1-02: 700
Phenomenon: Running jitter, slow response	Phenomenon: smooth operation and fast response

■ Model loop function turns on (fast positioning or fast position(control overshoot))

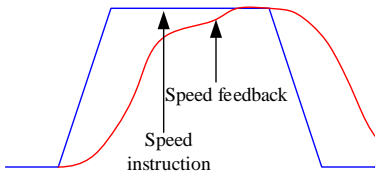
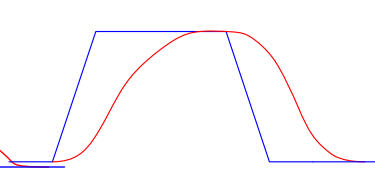
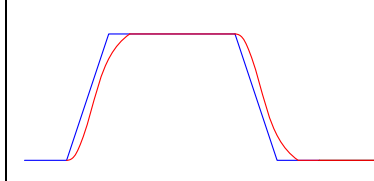
Low Rigidity and Low Response	High Rigidity and Low Response	High Rigidity and High Response
		
Load inertia ratio P0-07: 500%		
speed loop gain P1-00: 200	speed loop gain P1-00: 800	speed loop gain P1-00: 800

speed loop integral P1-01: 3300	speed loop integral P1-01: 825	speed loop integral P1-01: 825
position loop gain P1-02: 200	position loop gain P1-02: 700	position loop gain P1-02: 700
Model loop gain P2-49: 300	Model loop gain P2-49: 300	Model loop gain P2-49: 4000
Phenomenon: Running jitter, slow response	Phenomenon: smooth operation and slow response	Phenomenon: smooth operation and fast response

Note: The above curves only show the effect of the parameters, not the real running curves.

6.1.4 Torque disturbance observation

Disturbance observer can reduce the influence of external disturbance on servo system and improve the anti-disturbance ability by detecting and estimating the external disturbance torque of the system and compensating the torque command.

If the soft mode is selected in the auto-tuning mode, the disturbance observer will be closed automatically, and the gain of the disturbance observer will not change. If the fast positioning or fast positioning (control overshoot) is selected, the disturbance observer will be opened automatically, and the gain of the disturbance observer will be modified to 85. The relevant parameters of this function no need to be set manually by users.

Parameter		Meaning	Default setting	Modification	Effective
P2-00	n.□□□0	Turn-off of disturbance observer	n.□□□0	Servo bb	At once
	n.□□□1	Turn-on of disturbance observer			

Parameter	Meaning	Default setting	Unit	Setting range	Modify	Effective
P2-41	Disturbance observer gain	85	%	0~100	Anytime	At once

6.2 Rotary inertia presumption

6.2.1 Overview

Rotational inertia estimation is the function of automatic operation (forward and reverse) in the driver and estimate the load inertia in operation.

Rotational inertia ratio (the ratio of load inertia to motor rotor inertia) is a benchmark parameter for gain adjustment, and it must be set to the correct value as far as possible.

Parameter	Meaning	Default setting	Unit	Setting range	Modification	Effective
P0-07	First inertia ratio	200	%	0~50000	Anytime	At once

6.2.2 Notes

Occasions where inertia cannot be presumed

- Mechanical systems can only operate in one direction

The occasion where inertia presumption is easy to fail

- Excessive load moment of inertia
- The running range is narrow and the travel is less than 0.5 circles.
- The moment of inertia varies greatly during operation.
- Mechanical rigidity is low and vibration occurs when inertia is presumed.

Notes of Inertia Presumption

- Since both directions are rotatable within the set range of movement, please confirm the range or direction of movement; and ensure that the load runs in a safe journey.
- If the presumed inertia under default parameters runs jitter, indicating that the present load inertia is too large, please switch to large inertia mode (P2-03.3=1) and operate again. It is also possible to set the initial inertia to about twice the current one and execute again under larger loads.
- Driver inertia ratio recognition upper limit is 200 times (parameter upper limit is 20000). If the estimated inertia ratio is exactly 20000, it means that the inertia ratio has reached the upper limit and can not be used, please replace the motor with larger rotor inertia.

Other notes

- At present, the inertia switching function is not supported, and the second inertia ratio is invalid.
- The inertia ratio upper limit changes to 500 times for the driver firmware 3700 and higher version (parameter upper limit value is 50000).

6.2.3 Operation tool

The presumptive tools of load moment of inertia are driver panel and XinjeServo software.

Operation tool	Description
Driver panel	Driver firmware needs 3700 and higher version
XinjeServo software	All versions of software supported

Note: driver firmware version can be checked through U2-07.

6.2.4 Operation steps

Estimate the inertia through the driver panel

1. Parameter setting

Parameter	Meaning	Default setting	Unit	Range	Modification	Effective
P2-15	Inertia configured trip	100	0.01 circle	1~3000	Anytime	At once
P2-17	Inertia identification and internal instruction auto-tuning max speed	-	rpm	0~65535	Anytime	At once
P2-18	Inertia identification initial inertia ratio	500	%	1~20000	Anytime	At once

The recommended parameters of P2-17 are 500 rpm or more. Low instruction speed will lead to inaccurate identification of inertia ratio.

2. Execute the inertia identification

Before inertia identification, please confirm the direction of servo rotation by using F1-00 jog motion function. Initial direction of servo operation is determined by INC or DEC at the beginning of inertia identification.

If the servo jitter is under the adaptive default parameters, please switch to the adaptive large inertia mode (P2-03.3=1) to ensure the basic smooth operation of the servo and then identify the inertia!

Servo entering parameter F0-07 in BB state:

JA E -

Press ENTER, servo is enabled:

JA E - -

Press INC or DEC to run forward or reverse (select one of them):

JA E - P or JA E - n

At this point, start action, under the condition of P-05 = 0 (initial positive direction), if press INC, then turn forward and then reverse; if press DEC, turn reverse and then forward. If the inertia identification is successful, the load inertia ratio is prompted and written to P0-07 automatically after several forward and reverse operations. If the inertia identification error occurs, the error code will be displayed. Press STA/ESC key to exit the panel inertia identification operation.

■ Alarm for inertia identification of panel

Error code	Meaning	Reasons and solutions	Reasons
Err-1	Motor Torque Saturation	<p>① Initial inertia is too small; in adaptive mode, switch to large inertia mode P2-03.3=1 or the initial inertia of inertia identification P2-18 set to 2 times of the present value.</p> <p>② The maximum speed is too high (P2-17), but it is recommended not to be less than 500 rpm. Low</p>	Initial inertia too small; Maximum speed too large; Torque limit too small

		instruction speed will lead to inaccurate identification of inertia ratio. ③ torque limit too small (P3-28/29)	
Err-2	value error is too large when calculating the inertia	① The maximum speed limit is too small (P2-17), but it is recommended not to be less than 500 rpm. Low instruction speed will lead to inaccurate identification of inertia ratio. ② The presumed inertia trip is too small. It is suggested that the minimum for P2-15 should no be less than 50 (0.5 cycles). If the trip is too small, the identification of inertia ratio will be inaccurate. ③ mechanism friction too large ④ overshoot	The maximum speed limit is too small; the travel is too small; the friction of the mechanism is too large; the overrun occurs
Err-3	Driver internal trip calculation error	① The presumed inertia trip is too small. It is suggested that the minimum for P2-15 should no be less than 50 (0.5 cycles). If the trip is too small, the identification of inertia ratio will be inaccurate.	Contact us
Err-5	Unrestrained Vibration in the Process of Inertia Identification	Unhandled vibration occurs	Unhandled vibration occurs
Err-6	Driver is not currently in BB state	① Enable have been opened. P5-20 can be set to 0 first ② When the driver alarms, it will appear. Press ESC key to exit the auto-tuning interface to see if there is an alarm.	Will occur when enable is turned on or driver has alarm
Err-7	The driver alarms in the process of inertia identification	Driver has alarm, press ESC key to exit the auto-tuning interface, check the alarm code, first solve the alarm and then make inertia estimation.	Driver has alarm

Estimate the inertia through XinJeServo software

1. Click auto-tuning on the main interface of XinJeServo

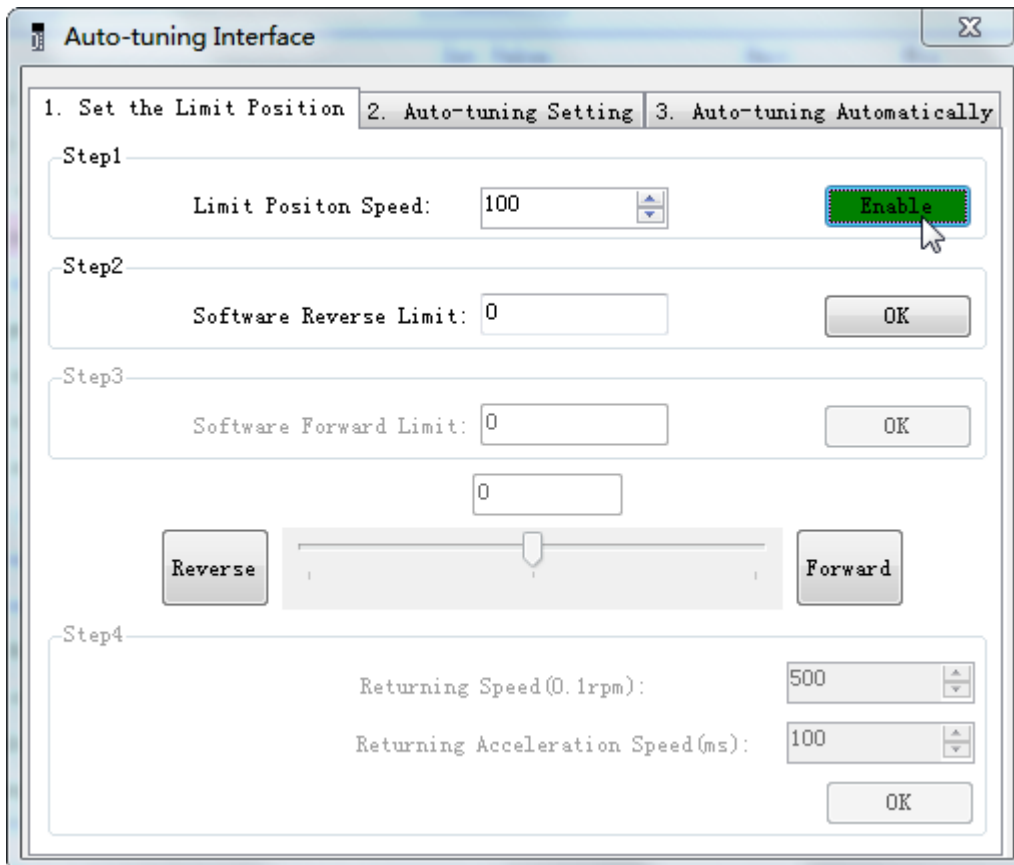

2. select jog setting or manual setting to configure the inertia estimation trip

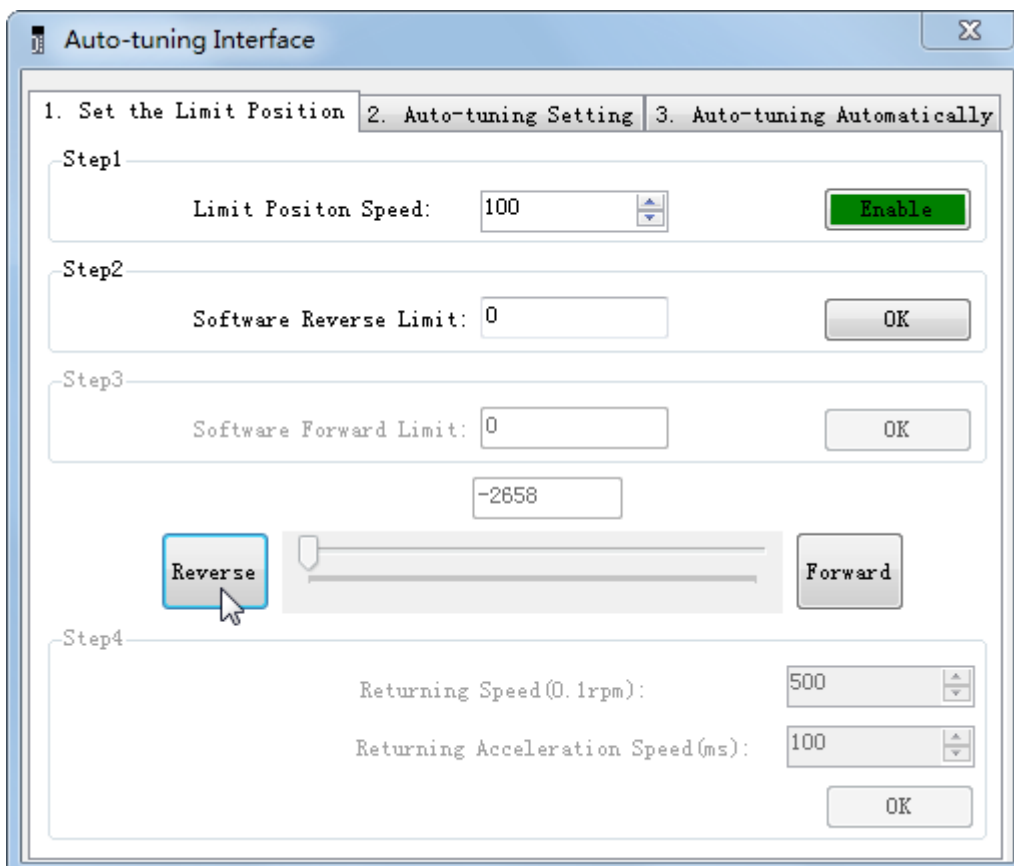

3. Set the auto-tuning interface

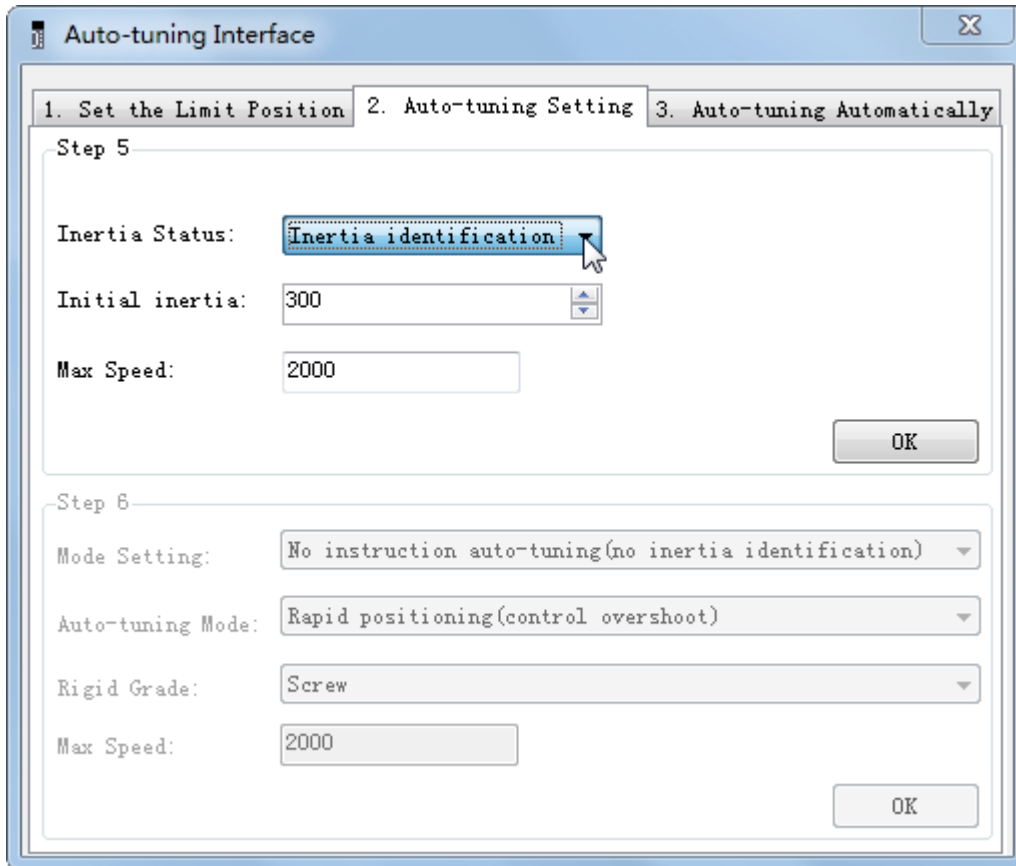

4. Click ok to start inertia identification.

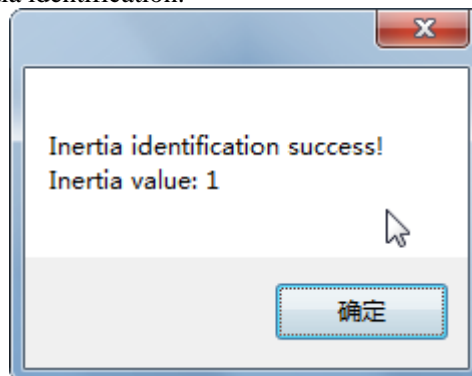

Note:

- (1) If the auto-tuning interface is closed directly, the driver only configures inertia ratio parameters.
- (2) The detailed steps of XinJeServo's presumptive inertia refer to XinJeServo's help document.

6.3 Fast adjustment

6.3.1 Overview

Fast adjustment needs to set the moment of inertia of load first, then turn off the adaptive function. If the inertia does not match, it will cause oscillation alarm. Servo firmware version 3640 and later versions support this function, and the version is viewed through U2-07. Fast adjustment of gain parameters belongs to auto-tuning mode.

6.3.2 Fast adjustment steps

1. estimate the load inertia through servo driver panel or XinJeServo software, refer to chapter 6.2
2. shut down adaptive mode, set P2-01.0 to 0
3. set the rigidity level P0-04

Note: P2-01.0 is the first bit of P2-01

P2-01=n. 0 0 1 0

6.3.3 Rigidity level corresponding gain parameters

■ 3640 firmware rigidity level

P0-04 Rigidity level	P1-00 Speed loop gain	P1-01 speed loop integral	P1-02 Position loop gain	P2-35 Torque instruction filter	P2-49 Model loop gain
1	100	6600	100	100	100
2	200	3300	200	100	300
3	300	2200	300	100	400
4	400	1650	400	100	500
5	450	1467	400	90	600
6	500	1320	450	80	700
7	550	1200	450	70	800
8	600	1100	500	60	900
9	650	1015	550	50	1000
10	700	943	600	40	1100
11	750	880	650	30	1200
12	800	825	700	20	1300
13	850	776	750	10	1400
14	900	733	800	10	1500
15	1000	660	900	10	1600
16	1050	629	950	10	1800
17	1100	600	1000	10	2000
18	1150	574	1050	10	2200
19	1200	550	1100	10	2400
20	1300	508	1100	10	2600
21	1400	471	1200	10	2800
22	1500	440	1300	10	3000
23	1600	413	1400	10	3500
24	1700	388	1500	10	4000
25	1800	367	1600	10	4500
26	1900	347	1700	10	5000
27	2000	330	1800	10	5500
28	2100	314	1900	10	6000
29	2200	300	2000	10	6500
30	2300	287	2100	10	7000
31	2400	275	2200	10	7500

■ 3700 and later firmware rigidity level

P0-04 Rigidity level	P1-00 Speed loop gain	P1-01 speed loop integral	P1-02 Position loop gain	P2-35 Torque instruction filter	P2-49 Model loop gain(version 3700~3720)	P2-49 Model loop gain(version after 3730)
----------------------------	-----------------------------	---------------------------------	--------------------------------	--	---	--

1	20	31831	20	100	50	50
2	50	12732	50	100	80	80
3	70	9094	70	100	90	90
4	80	7957	80	100	100	100
5	100	6366	100	100	100	120
6	120	5305	120	100	150	150
7	140	4547	140	100	150	200
8	160	3978	160	100	200	250
9	180	3536	180	100	250	310
10	200	3183	200	100	300	350
11	220	2893	220	100	300	380
12	240	2652	240	100	350	410
13	260	2448	260	100	350	440
14	280	2273	280	100	350	470
15	300	2122	300	100	400	500
16	320	1989	320	100	400	540
17	340	1872	340	100	400	580
18	360	1768	360	100	450	620
19	380	1675	380	100	450	660
20	400	1591	400	100	500	700
21	450	1414	400	90	600	800
22	500	1273	450	80	700	950
23	550	1157	450	70	800	1100
24	600	1061	500	60	900	1300
25	650	979	550	50	1000	1500
26	700	909	600	40	1100	1800
27	750	848	650	30	1200	2100
28	800	795	700	20	1300	2400
29	850	748	750	10	1400	2700
30	900	707	800	10	1500	3000
31	950	670	900	10	1500	3100
32	1000	636	900	10	1600	3200
33	1050	606	950	10	1800	3300
34	1100	578	1000	10	2000	3400
35	1150	553	1050	10	2200	3500
36	1200	530	1100	10	2400	3600
37	1250	509	1100	10	2500	3700
38	1300	489	1100	10	2600	3800
39	1350	471	1200	10	2700	3900
40	1400	454	1200	10	2800	4000
41	1450	439	1250	10	2900	4100
42	1500	424	1300	10	3000	4200
43	1550	410	1350	10	3200	4300
44	1600	397	1400	10	3500	4400
45	1650	385	1450	10	3800	4500
46	1700	374	1500	10	4000	4600
47	1750	363	1750	10	4500	4800
48	1800	353	1800	10	5000	5000
49	1850	344	1850	10	5000	5000
50	1900	335	1900	10	5000	5000
51	1950	326	1950	10	5000	5000
52	2000	318	2000	10	5000	5000
53	2050	310	2050	10	6000	6000
P0-04 Rigidity level	P1-00 Speed loop gain	P1-01 speed loop integral	P1-02 Position loop gain	P2-35 Torque instruction filter	P2-49 Model loop gain(version 3700~3720)	P2-49 Model loop gain(version after 3730)

54	2100	303	2100	10	6000	6000
55	2150	296	2150	10	6000	6000
56	2200	289	2200	10	6000	6000
57	2250	282	2250	10	6000	6000
58	2300	276	2300	10	6000	6000
59	2350	270	2350	10	6000	6000
60	2400	265	2400	10	6000	6000
61	2450	259	2450	10	6000	6000
62	2500	254	2500	10	6000	6000
63	2600	244	2600	10	6000	6000

The rigidity level should be set according to the actual load. The larger the P-04 value, the greater the servo gain. If there is vibration in the process of increasing the rigidity level, it is not suitable to continue to increase. If vibration suppression is used to eliminate vibration, it can try to continue to increase. The following is the recommended rigidity level of the load, for reference only.

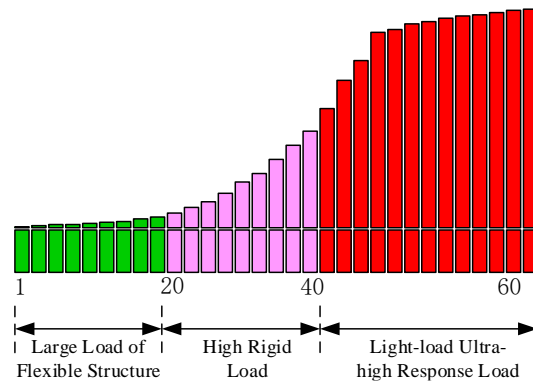

Flexible structure large load: refers to the type of synchronous belt structure, large load inertia equipment.

High rigid load: refers to the mechanism of screw rod or direct connection, and equipment with strong mechanical rigidity.

Ultra-high response load under light load: refers to equipment with very small inertia, strong mechanical stiffness and high response.

Driver power	Default parameters	Rigidity level for firmware 3640	Rigidity level for firmware 3700 and higher versions
1.5kw and above	P1-00=200 P1-01=3300 P1-02=200 P2-35=100 P2-49=300	2	10
200w~750w	P1-00=300 P1-01=2200 P1-02=300 P2-35=100 P2-49=400	3	15
100w	P1-00=400 P1-01=1650 P1-02=400 P2-35=100 P2-49=500	4	20

6.3.4 Notes

- The gain parameters corresponding to the rigidity level can be independently fine-tuned in the fast adjustment mode.
- In order to ensure stability, the gain of model loops is small at low rigidity level, which can be added separately when there is high response requirement.
- When vibration occurs in fast adjustment, the torque instruction filter P2-35 can be modified. If it is ineffective, the mechanical characteristic analysis can be used and the relevant notch parameters can be set (refer to chapter 6.7 vibration suppression).
- Fast adjustment mode defaults to set a rigidity level. If the gain does not meet the mechanical requirements, please gradually increase or decrease the settings.
- At present, gain switching function is not supported, that is, the second gain parameters such as P1-05, P1-06, P1-07 are invalid.

6.4 Auto-tuning

6.4.1 Overview

Auto-tuning is divided into internal instruction auto-tuning and external instruction auto-tuning.

Auto-tuning (internal instruction) refers to the function of automatic operation (forward and reverse reciprocating motion) of servo unit without instructions from the upper device and adjusting according to the mechanical characteristics in operation.

Auto-tuning (external instruction) is the function of automatically optimizing the operation according to the instructions from the upper device.

The automatic adjustments are as follows:

- Load moment of inertia
- Gain parameters (speed loop, position loop, model loop gain)
- Filter (notch filter, torque instruction filter)

6.4.2 Notes

Untunable occasions

- Mechanical systems can only operate in one direction.

Setting occasions that are prone to failure

- Excessive load moment of inertia;
- The moment of inertia varies greatly during operation.
- Low mechanical rigidity, vibration during operation and failure of detection positioning;
- The running distance is less than 0.5 circles.

Preparations before auto-tuning

- Use position mode;
- Driver in BB state;
- Driver without alarm;
- The matching of the number of pulses per rotation and the width of positioning completion should be reasonable.

6.4.3 Operation tools

Internal instruction auto-tuning and external instruction auto-tuning can be executed by driver panel and XinJeServo software.

Auto-tuning mode	Operation tools	Limit item
Internal instruction auto-tuning	XinJeServo software	All the versions support
external instruction auto-tuning	Driver panel	Driver firmware needs 3700 and higher versions

Note: please check the driver firmware version through U2-07.

6.4.4 Internal instruction auto-tuning steps

Driver panel auto-tuning steps

1. The inertia identification is carried out, and the inertia estimation steps please refer to chapter 6.2.4 operation steps.
2. Enter F0-09, panel display is iat-;

iat -

3. Press ENTER, panel display is iat--, servo is in enabled status right now;

iat --

4. Press INC or DEC, panel display is tune and flashing, enter auto-tuning status;

tune

5. Driver will automatically send pulse instructions, if the auto-tuning is successful, the panel shows done and flashing.

done

6. Press STA/ESC to exit internal instruction auto-tuning.

Note: In the process of auto-tuning, press STA/ESC will exit the auto-tuning operation and use the gain parameters at the exit time. If auto-tuning fails, it is necessary to initialize the driver before auto-tuning again.

■ Panel alarm in auto-tuning process

Error code	Meaning	Reasons
Err-1	Failure to search for optimal gain	Too large inertia ratio; too weak rigidity of mechanism
Err-2	Overtrip alarm in auto-tuning process	Please make sure that there is no overrun and alarm before auto-tuning.
Err-6	Driver is not in "bb" state at the time of operation	Please make sure the present status of driver
Err-7	Driver alarmed in auto-tuning process	The driver alarm occurs

XinJeServo software auto-tuning steps

1. click auto-tuning on the XinJeServo software main interface
2. set the auto-tuning trip in jog mode or manually

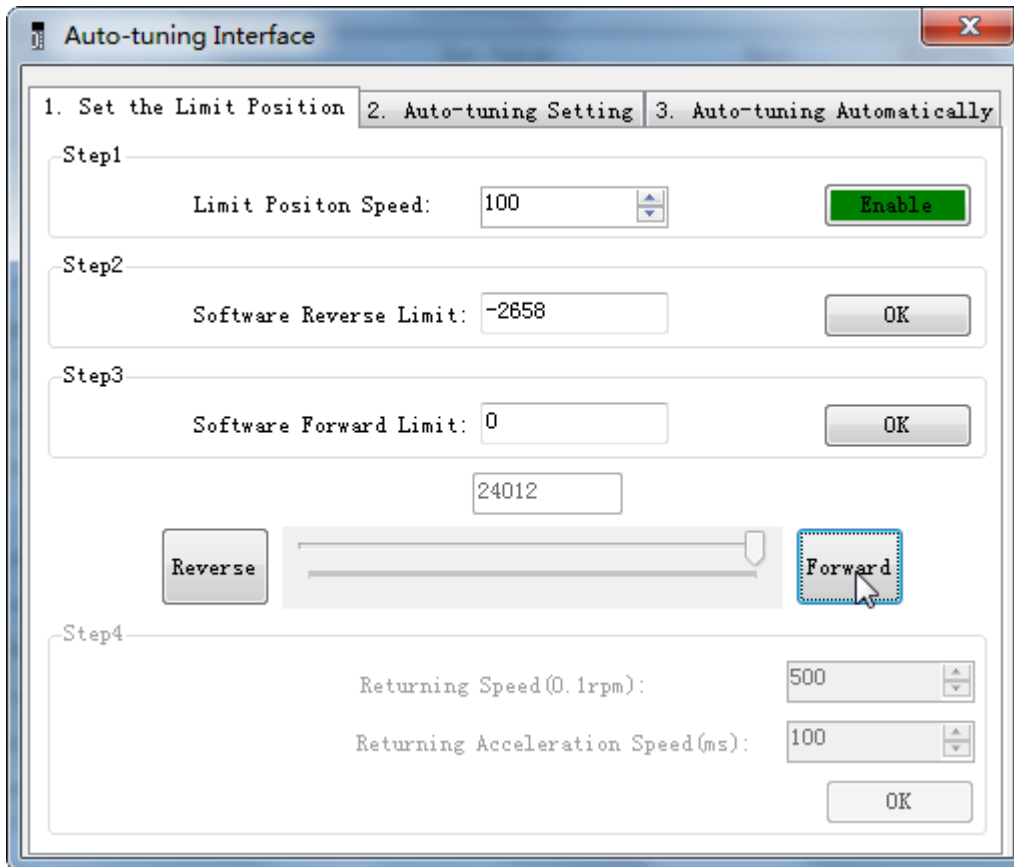

3. set the auto-tuning interface

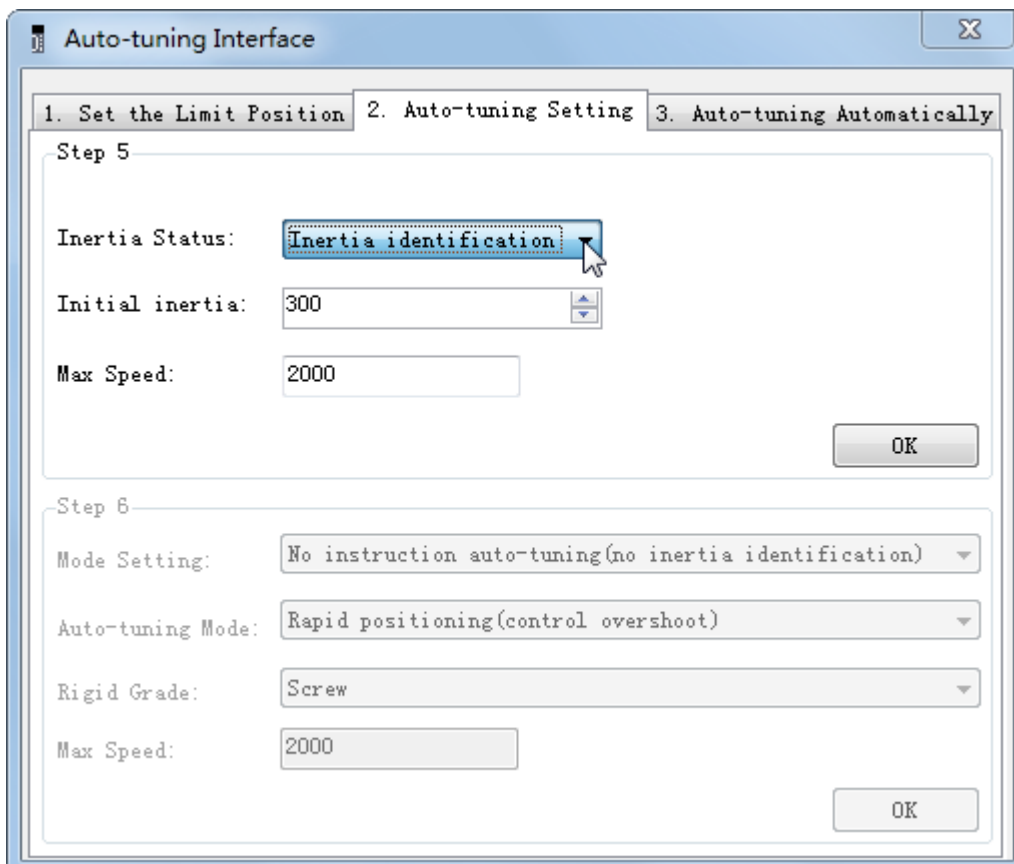

- click ok to estimate the inertia.

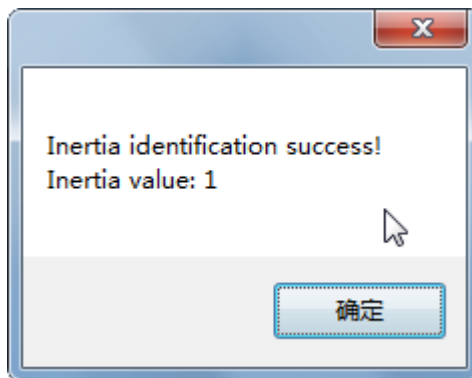

- set the auto-tuning parameters

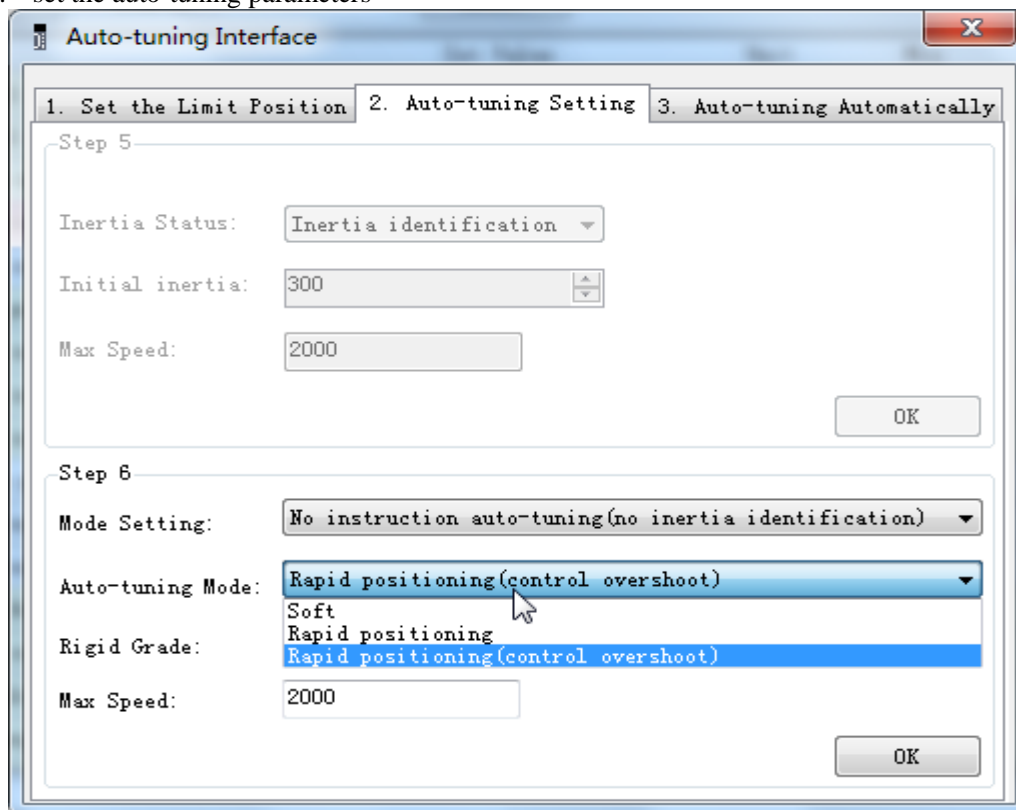

Load type	Description
Synchronous belt	Fit for the adjustment of lower rigidity mechanism such as synchronous belt mechanism.
Screw rod	It is suitable for adjustment of higher rigidity mechanism such as ball screw mechanism. If there is no corresponding mechanism, please choose this type.
Rigid connection	It is suitable for the adjustment of rigid body system and other mechanisms with higher rigidity.

Auto-tuning mode	Description
Soft	Make a soft gain adjustment. Besides gain adjustment, notch filter is automatically adjusted.
Fast positioning	Make special adjustment for positioning purpose. Besides gain adjustment, the model loop gain and notch filter are automatically adjusted.

Fast positioning (control overshoot)	In the use of positioning, we should pay attention to adjusting without overshoot. Besides gain adjustment, the model loop gain and notch filter are automatically adjusted.
---	--

6. Start auto-tuning

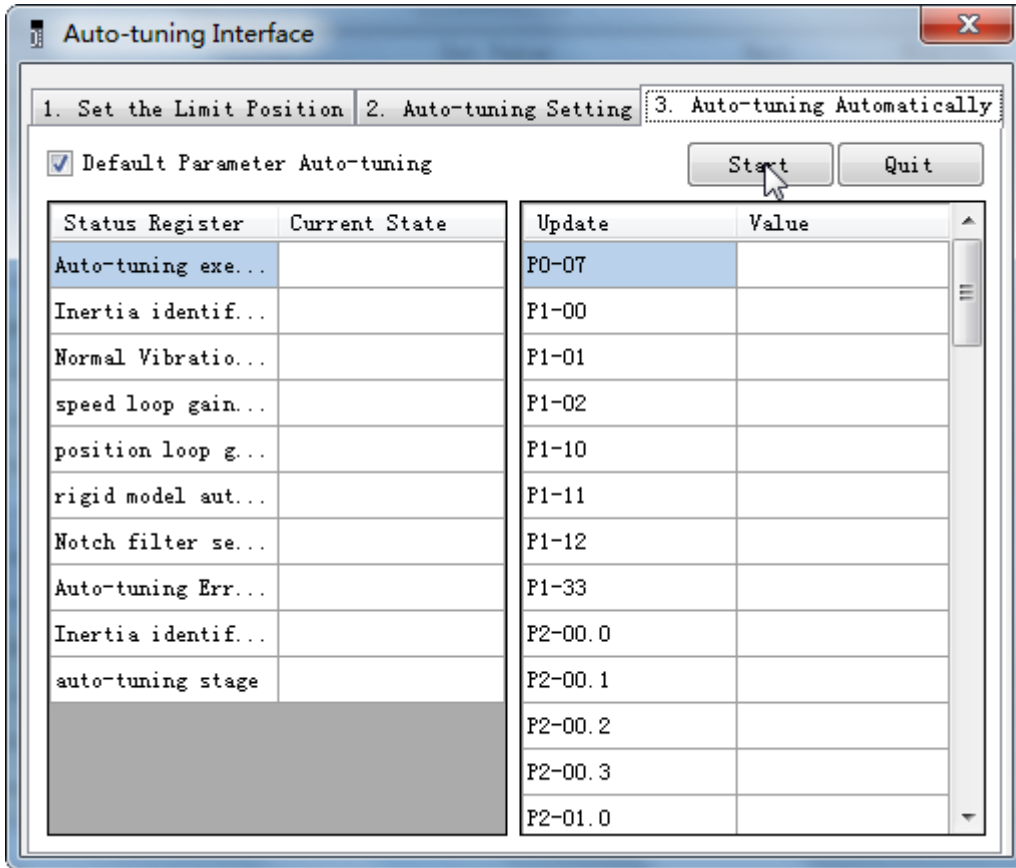

7. Wait for the end of the auto-tuning

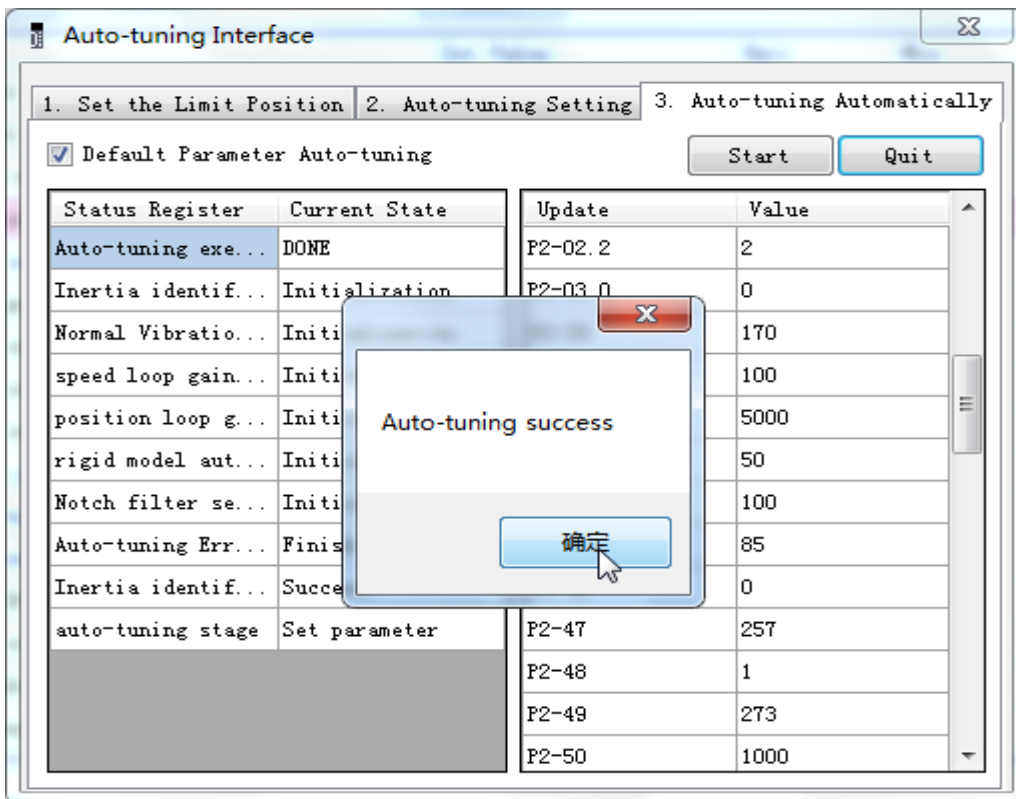

6.4.5 External instruction auto-tuning steps

Driver panel auto-tuning steps

1. The inertia identification is carried out and the step of inertia estimation please refers to the driver panel inertia estimation (6.2.4 operation step)
2. Shut down adaptive function (P2-01.0 sets to 0), power on again
3. Enter parameter F0-08, it will show Eat- (External Reference Auto-tuning)

EAT-

4. Press ENTER, if the enabler is not open, the panel displays Son and flickers, waiting for the enabler to open, if the enabler has been opened, skip this step;

Son

5. Turn on the servo enabler, the panel displays tune and flickers, enter auto-tuning status.

TUNE

6. The upper device starts to send pulse, if the auto-tuning is successful, it displays done and flickers.

done

7. Press STA/ESC to exit the external instruction auto-tuning.

Note: in the auto-tuning process, press STA/ESC will exit the auto-tuning, and use the gain parameters at the exit moment.

■ Panel error alarm in auto-tuning process

Error code	Meaning	Reasons
Err-1	Failure to search for optimal gain	Too large inertia ratio; too weak rigidity of mechanism
Err-2	①Overrun/alarm occurs during auto-tuning ②External instruction auto-tuning/Vibration suppression mode: servo shut down the enabler during auto-tuning	Please make sure that there is no overrun and alarm before auto-tuning. Make sure that the enable is not closed during auto-tuning
Err-3	Current non-position control mode	Please auto-tune in position mode
Err-4	Unclosed adaptive function	Set P2-01.0 to 0 before auto-tuning
Err-7	Driver alarm during auto-tuning	Driver alarmed
Err-8	Positioning completion signal instability	Short instruction interval

XinJeServo software auto-tuning steps

1. Click auto-tuning on the main interface of XinJeServo software

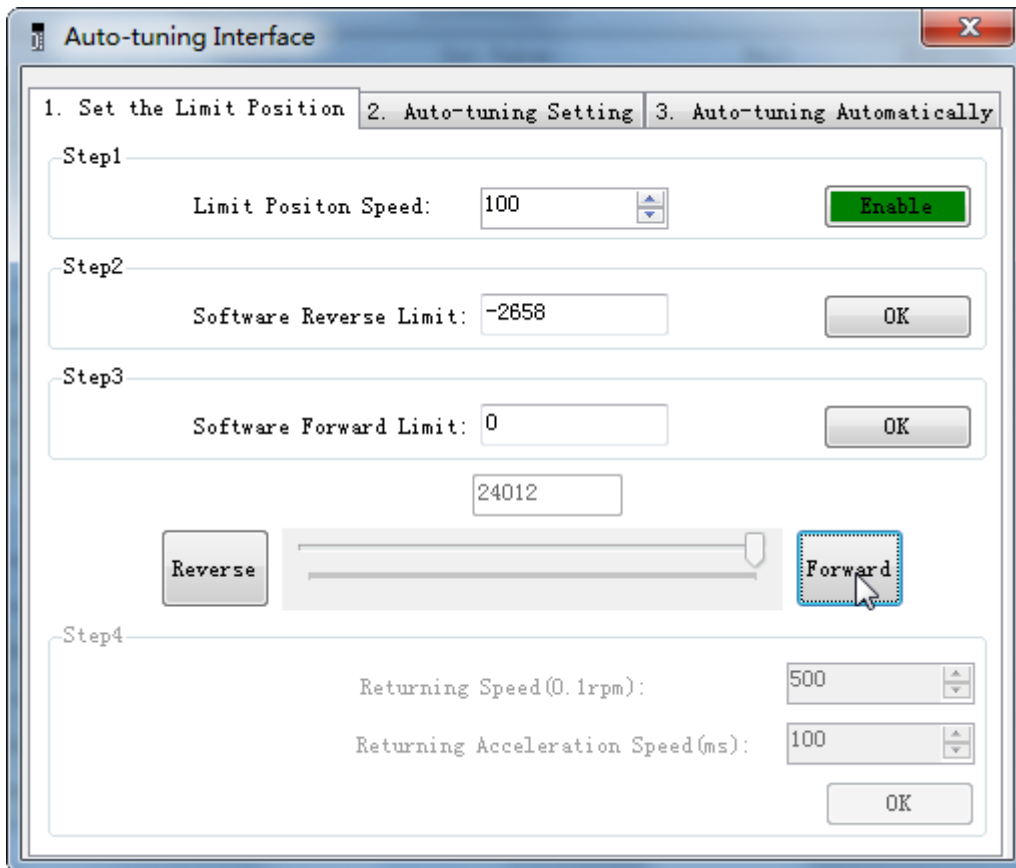

2. Select jog or manual setting to configure the trip of inertia identification.
3. Set the auto-tuning interface

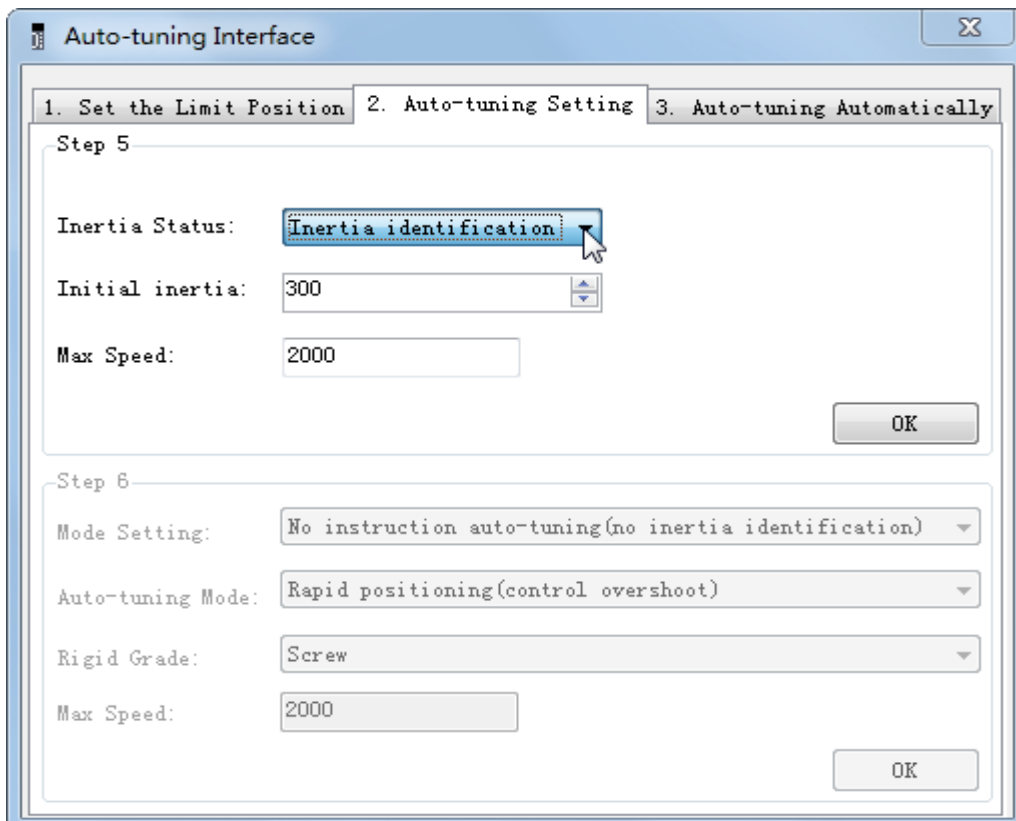

4. Click ok to start the inertia identification.

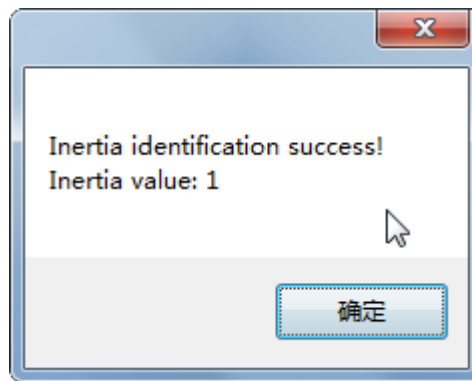

5. Configure the auto-tuning parameters

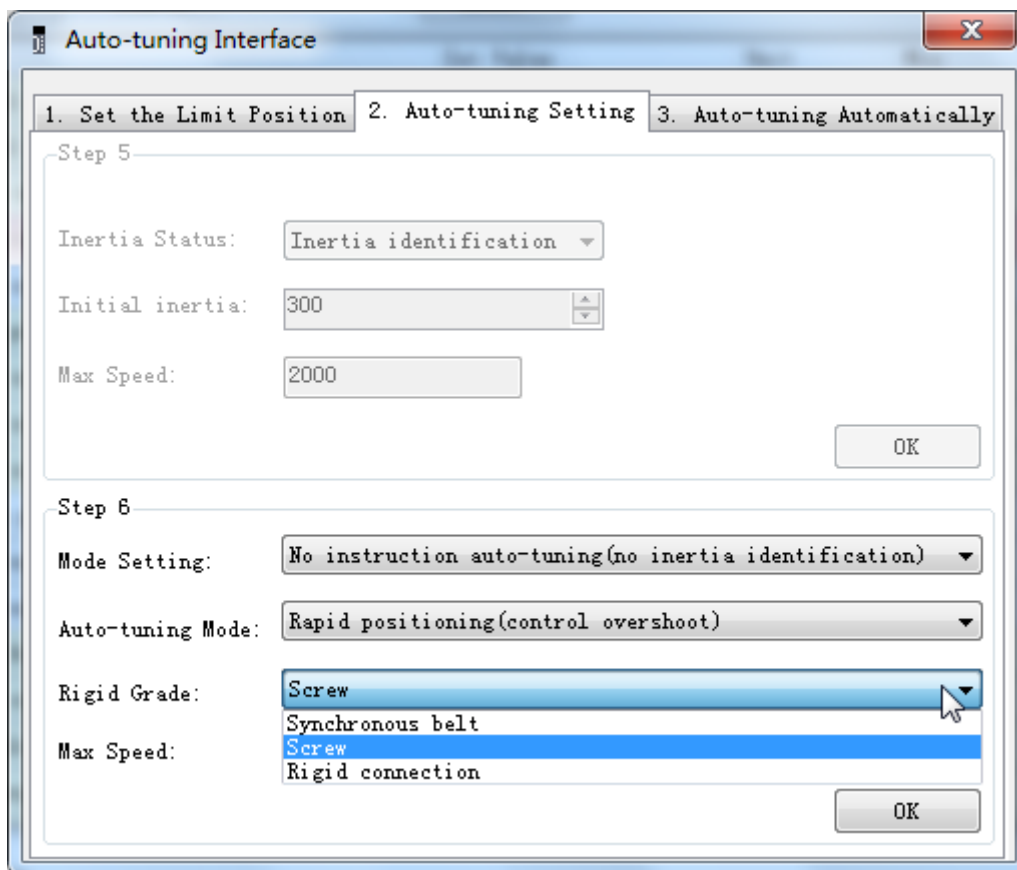

Auto-tuning mode	Description
Soft	Make a soft gain adjustment. Besides gain adjustment, notch filter is automatically adjusted.
Rapid positioning	Make special adjustment for positioning purpose. Besides gain adjustment, the model loop gain and notch filter are automatically adjusted.
Rapid positioning (control overshoot)	In the use of positioning, we should pay attention to adjusting without overshoot. Besides gain adjustment, the model loop gain and notch filter are automatically adjusted.

Load type	Description
Synchronous belt	Adjustment of lower rigidity mechanism such as synchronous belt
Screw	It is suitable for adjusting higher rigidity mechanism such as ball screw mechanism. If there is no corresponding mechanism, please choose this type.

Rigid connection	It is suitable for the adjustment of rigid body system and other mechanisms with higher rigidity.
------------------	---

6. Start auto-tune

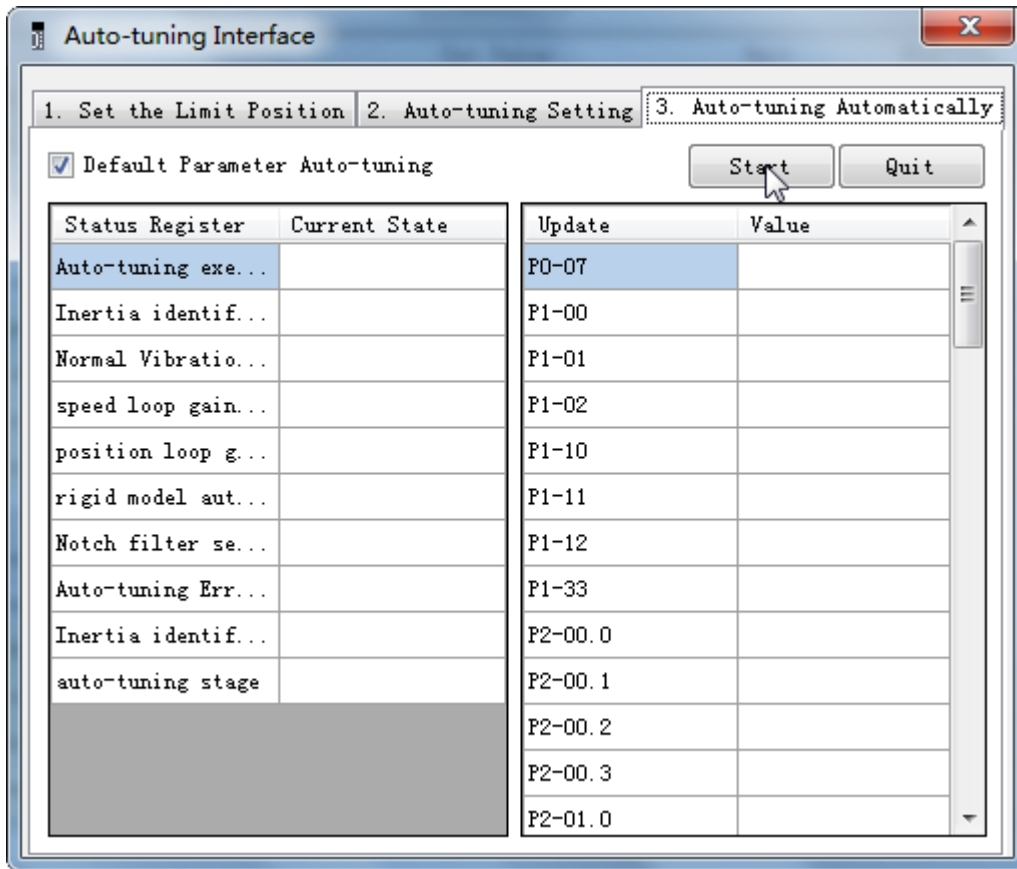

7. Open the servo enable, then click ok.

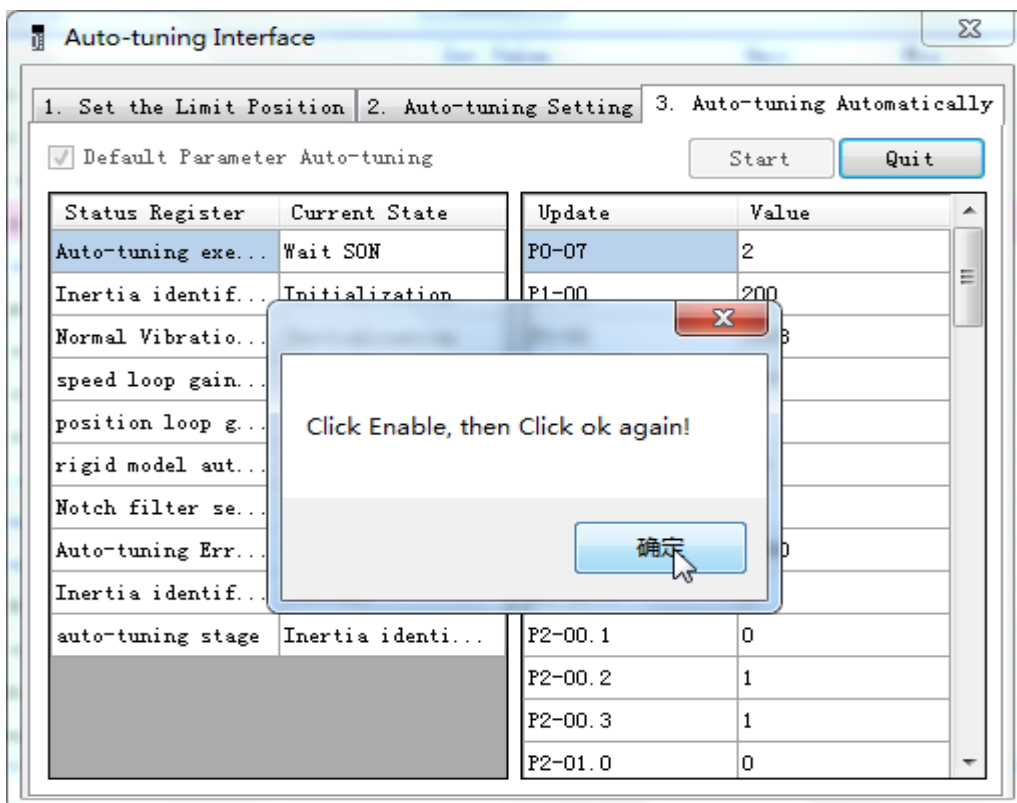

8. The upper device starts to send pulses, wait the completion of auto-tuning.
9. Auto-tuning is finished, click ok.

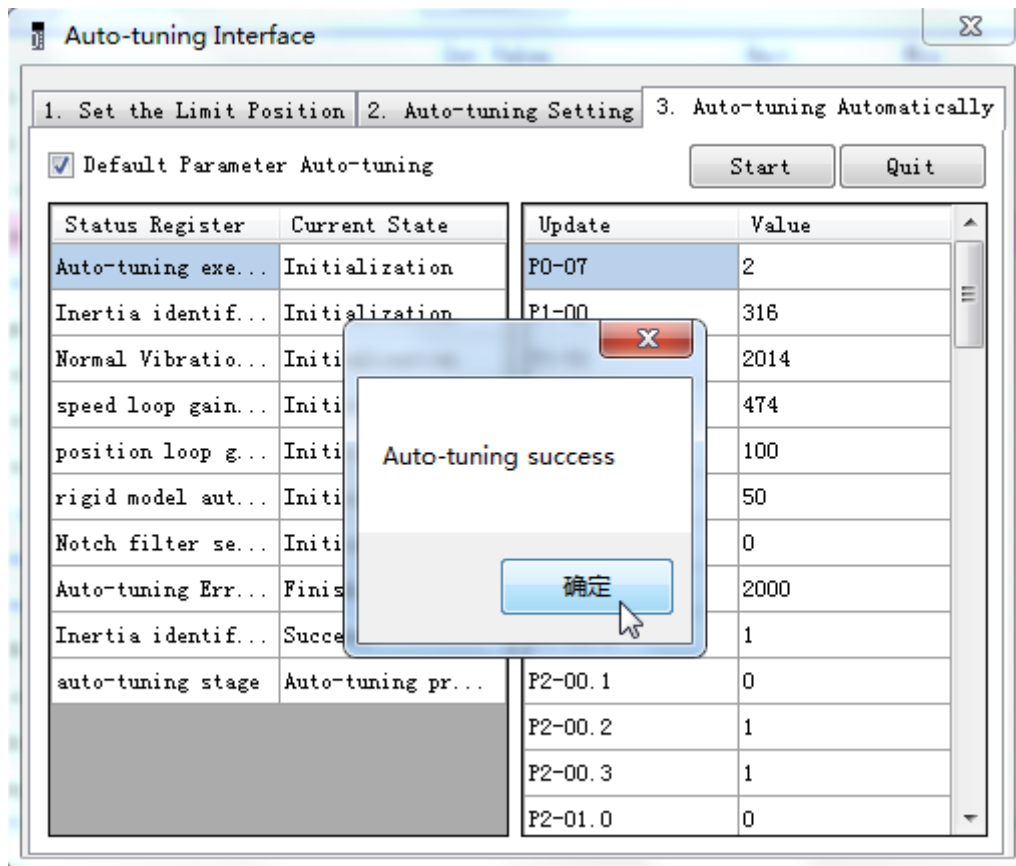

6.4.6 Related parameters

The following parameters may be modified during auto-tuning. Do not change them manually during auto-tuning.

Parameter	Name	Property	The influence of numerical value on gain after auto-tuning
P0-07	First inertia ratio	Gain performance parameters	Yes
P1-00	First speed loop gain		
P1-01	Integral time constant of the first speed loop		
P1-02	First position loop gain		
P2-00.0	Disturbance observer switch		
P2-01.0	Adaptive mode switch		
P2-35	Torque command filter time constant 1		
P2-41	Disturbance observer gain		
P2-47.0	model loop switch		
P2-49	model loop gain		
P2-55	model speed feedforward gain		
P2-60.0	Active vibration suppression switch		
P2-61	Active vibration suppression frequency		
P2-62	Active vibration suppression gain		
P2-63	Active vibration suppression damping		

P2-69.0	First notch switch		
P2-69.1	Second notch switch		
P2-71	First notch frequency		
P2-72	First notch attenuation		
P2-73	First notch band width		
P2-74	Second notch frequency		
P2-75	Second notch attenuation		
P2-76	Second notch band width		
P2-17	Inertia identification and internal instruction auto-tuning max speed	Auto-tuning setting parameters	No
P2-86	auto-tuning jog mode		
P2-87	auto-tuning min limit position		
P2-88	auto-tuning max limit position		
P2-89	auto-tuning max speed		
P2-90	auto-tuning acceleration/deceleration time		

Note: P2-60~P2-63 are automatically modified in auto-tuning process. Users are not allowed to modify them manually. Manual modification may lead to the risk of system runaway.

6.5 Manual adjustment

6.5.1 Overview

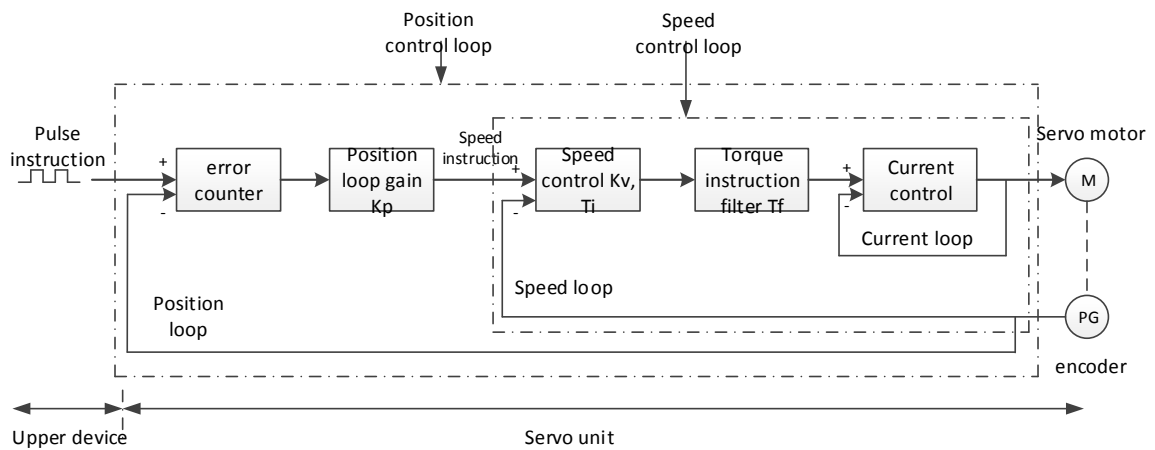

Position control loop diagram (shut down the model loop)

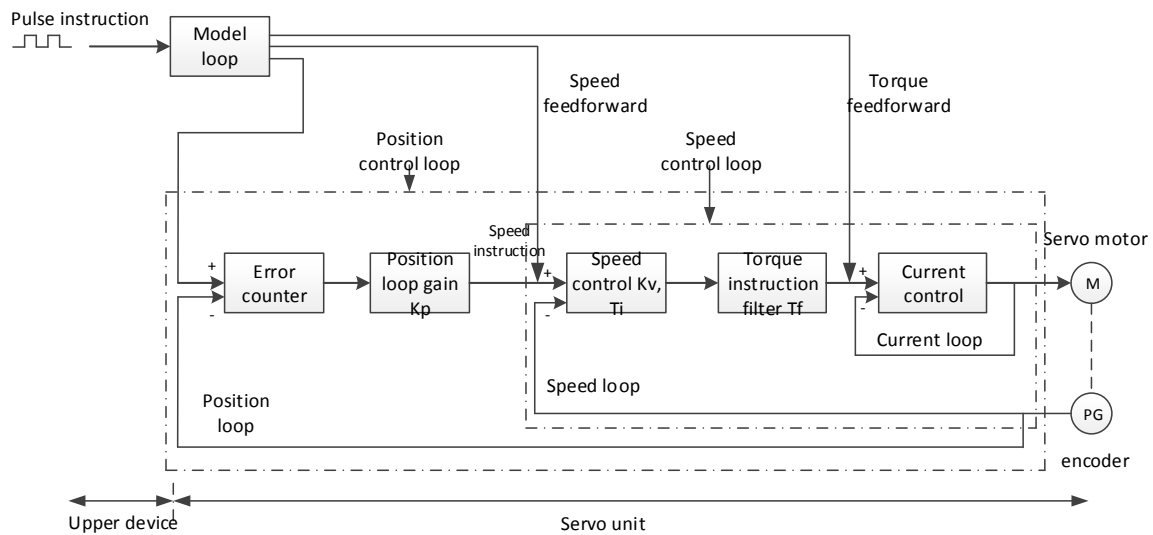

Position control loop diagram (turn on the model loop)

Servo unit consists of three feedback loops (current loop, speed loop and position loop) from inside to outside. The more inner loop, the more responsive it is. Failure to comply with this principle will result in poor response or vibration. Among them, the current loop parameters are fixed values to ensure adequate responsiveness, and users do not need to adjust.

Please use manual adjustment in the following occasions:

- When the expected effect can not be achieved by fast adjusting the gain
- When the expected effect is not achieved by automatically adjusting the gain

6.5.2 Adjustment steps

In position mode, if the soft mode (P2-02.0=1) is selected by auto-tuning, the function of model loop will be turned off; in speed mode, the gain of position loop will be invalid.

Increasing response time

1. Reducing the filter time constant of torque instruction (P2-35)
2. Increasing Speed Loop Gain (P1-00)
3. Reducing Integral Time Parameter of Speed Loop (P1-01)
4. Increasing the gain of position loop (P1-02)
5. Improving Model Loop Gain (P2-49)

Reduce response, prevent vibration and overshoot

1. Reducing the Speed Loop Gain (P1-00)
2. Increasing Integral Time Constant of Speed Loop (P1-01)
3. Reducing the gain of position loop (P1-02)
4. Increase the filter time constant of the torque instruction (P2-35)
5. Reducing Model Loop Gain (P2-49)

6.5.3 Gain parameters for adjustment

The gain parameters that need to be adjusted:

- P1-00 Speed Loop Gain
- P1-01 Integral Time Constant of Speed Loop
- P1-02 position loop gain
- P2-35 Torque Instruction Filtering Time Constant
- P2-49 Model Loop Gain

■ Speed loop gain

Because the response of the speed loop is low, it will become the delay factor of the outer position loop, so overshoot or vibration of the speed command will occur. Therefore, in the range of no vibration of mechanical system, the larger the setting value, the more stable the servo system and the better the responsiveness.

Parameter	Name	Default setting	Unit	Range	Modification	Effective
P1-00	Speed loop gain	200	0.1Hz	10~20000	Anytime	At once

■ Integral time constant of speed loop

In order to respond to small inputs, the speed loop contains integral elements. Because this integral factor is a delay factor for servo system, when the time constant is too large, it will overshoot or prolong the positioning time, which will make the response worse.

The relationship between the gain of the speed loop and the integral time constant of the speed loop is approximately as follows:

$$P1-00 \times P1-01 = 636620$$

Parameter	Name	Default setting	Unit	Range	Modification	Effective
P1-01	integral time constant of speed loop	3300	0.01ms	15~51200	Anytime	At once

■ Position loop gain

When the model loop is invalid (P2-47.0=0), the responsiveness of the position loop of the servo unit is determined by the gain of the position loop. The higher the position loop gain is, the higher the responsiveness is and the shorter the positioning time is. Generally speaking, the gain of position loop cannot be increased beyond the natural vibration number of mechanical system. Therefore, in order to set the position loop gain to a larger value, it is necessary to improve the rigidity of the machine and increase the number of inherent vibration of the machine.

Parameter	Name	Default setting	Unit	Range	Modify	Effective
P1-02	Position loop gain	200	0.1/s	10~20000	Anytime	At once

■ Filter time constant of torque instruction

When machine vibration may be caused by servo drive, it is possible to eliminate vibration by adjusting the filtering time parameters of the following torque instructions. The smaller the numerical value, the better the response control can be, but it is restricted by the machine conditions. When vibration occurs, the parameter is generally reduced, and the adjustment range is suggested to be 10-150.

Parameter	Name	Default setting	Unit	Range	Modify	Effective
P2-35	Filter time constant of torque instruction 1	100	0.01ms	0~65535	Anytime	At once

■ Model loop gain

When the model loop is valid (P2-47.0=1), the response of the servo system is determined by the gain of the model loop. If the gain of the model loop is increased, the responsiveness is increased and the positioning time is shortened. At this time, the response of the servo system depends on this parameter, not P1-02 (position loop gain). The gain of the model loop is only valid in position mode.

Parameter	Name	Default setting	Unit	Range	Modify	Effective
P2-49	Model loop gain	500	0.1Hz	10~20000	Anytime	At once

6.6 Adaptive

6.6.1 Overview

Adaptive function means that no matter what kind of machine and load fluctuation, it can obtain stable response through automatic adjustment. It starts to automatically adjust when servo is ON.

6.6.2 Notes

- When the servo unit is installed on the machine, it may produce instantaneous sound when the servo is ON. This is the sound when the automatic notch filter is set, not the fault. For the next time the servo is ON, no sound will be emitted.
- When the inertia of the motor exceeds the allowable load, the motor may produce vibration. At this time, please modify the adaptive parameters to match the present load inertia.
- In adaptive operation, in order to ensure safety, the adaptive function should be executed at any time when the servo enablement can be stopped or turned off urgently.

6.6.3 Operation steps

The factory settings are self-adaptive effective without modifying other parameters. The effectiveness of self-adaptation is controlled by the following parameters.

Parameter	Meaning	Default setting	Modification	Effective	
P2-01	n.□□□0	Adaptive shutdown	n.□□□1	Servo bb	Re-power on
	n.□□□1	Adaptive Opening			

6.6.4 Inertia mode and related parameters

The adaptive default parameter is defined as small inertia mode. If the load inertia far exceeds the allowable load inertia of the motor (such as 60 times inertia of the 60 motor), the adaptive large inertia mode can be turned on.

Parameter	Meaning	Default setting	Modification	Effective	
P2-03	n.0□□□	Adaptive small inertia mode	n.0□□□	Servo bb	Re-power on
	n.1□□□	Adaptive large inertia mode			

Parameter	Meaning	Default setting	Modification	Effective
P2-05	Adaptive speed loop gain	400 ^{Note1}	Servo bb	At once
P2-10	Adaptive speed loop integral	500	Servo bb	At once
P2-11	Adaptive position loop gain	100	Servo bb	At once
P2-07	Adaptive inertia ratio	0	Servo bb	At once
P2-08	Adaptive speed observer gain	60	Servo bb	At once
P2-12	Adaptive stable max inertia ratio	30	Servo bb	At once
P2-16	Adaptive motor rotor inertia coefficient	100	Servo bb	At once
P2-19	Adaptive bandwidth	50 ^{Note2}	Servo bb	At once

P6-05	Adaptive large inertia mode speed loop gain	200	Servo bb	At once
P6-07	Adaptive large inertia mode inertia ratio	50	Servo bb	At once
P6-08	Adaptive large inertia mode speed observer gain	40	Servo bb	At once
P6-12	Adaptive large inertia mode max inertia ratio	50	Servo bb	At once

Note 1: DS5 series servo 750W and below driver default value is 400; other power section default value is 200.

Note 2: DS5 series servo 400W and below driver default value is 70; other power section default value is 50.

6.6.5 Recommended inertia ratio parameters

Under the adaptive default parameters, the load can only run steadily under a certain moment of inertia. If the load inertia is large, some parameters need to be adjusted. The recommended parameters are as follows (the parameters are modified under the default parameters).

Motor flange	Inertia	Parameters
40~90	Within 20 times inertia	Adaptive small inertia mode (default parameters)
	20-30 times inertia	Set P2-08=50, P2-12=40
	30-40 times inertia	Set P2-08=50, P2-12=40, P2-07=10
	40-50 times inertia	Set P2-08=50, P2-12=40, P2-07=30
	50-80 times inertia	Switch to adaptive large inertia mode or set P2-08=40, P2-12=50, P2-07=50
110/130	Within 10 times inertia	Adaptive small inertia mode (default parameters)
	10-15 times inertia	Set P2-08=50, P2-12=40
	15-20 times inertia	Switch to adaptive large inertia mode or set P2-08=40, P2-12=50, P2-07=50
180 and above	Within 5 times inertia	Adaptive small inertia mode (default parameters)
	5-10 times inertia	Set P2-08=50, P2-12=40
	10-20 times inertia	Switch to adaptive large inertia mode or set P2-08=40, P2-12=50, P2-07=50

Note: The large inertia parameters can still drive a smaller inertia load. For example, when the parameters of 50 times inertia are used in the mechanism of 20 times inertia, only the response will become worse.

6.6.6 Adaptive parameters effect

Parameter Small inertia/large inertia	Name	Default value	Range	Effect
P2-05/P6-05	Adaptive speed loop gain	400/200	200-400	Reduction can improve the inertia capability, but it will reduce the responsiveness, which has a greater impact on the responsiveness.
P2-07/P6-07	Adaptive load inertia ratio	0/50	0-200	Increase can greatly improve the inertia capacity without affecting the responsiveness. Too large will produce vibration.

P2-08/P6-08	Speed observer gain	60/40	30-60	Reducing P2-08 and increasing P2-12 can greatly improve the inertia capability, but it will reduce the responsiveness, which has a great impact on responsiveness.
P2-12/P6-12	Adaptive stable max inertia ratio	30/50	30-60	
P2-10	Adaptive speed loop integral time coefficient	500	200-larger	Adjust according to need, generally increase
P2-11	Adaptive position loop gain coefficient	100	50-200	Adjust according to the need, increasing will make the response fast, reducing will make the response slow
P2-16	Adaptive motor rotor inertia coefficient	100	100-200	Increasing will improve the servo rigidity and enhance anti-disturbance ability, can solve operation jitter.
P2-19	Adaptive bandwidth	50~70	40-80	Increasing will improve the inertia capacity slightly, and has little effect on the responsiveness, to be an auxiliary parameter.

6.6.7 Invalid parameters when adaptive effective

When the adaptive function is effective (P2-01.0=1), the invalid parameters are shown as below:

Item	Parameters	Descriptions
Gain	P1-00	First speed loop gain
	P1-05	Second speed loop gain
	P1-01	First speed loop integral time constant
	P1-06	Second speed loop integral time constant
	P1-02	First position loop gain
	P1-07	Second position loop gain
	P2-49	Model loop gain
Switch	P0-07	First inertia ratio
	P0-08	Second inertia ratio
Switch	P5-33	/G-SEL gain switch
	P5-36	/I-SEL inertia ratio switch

6.7 Vibration suppression

6.7.1 Overview

The mechanical system has a certain resonance frequency. When the servo gain is increased, the continuous vibration may occur near the resonance frequency of the mechanical system. Generally in the range of 400Hz to 1000Hz, it caused the gain can not continue to increase. Vibration can be eliminated by automatically detecting or manually setting the vibration frequency. After the vibration is eliminated, if the responsiveness needs to be improved, the gain can be further improved.

Note:

- (1) Servo responsiveness will change after vibration suppression operation.
- (2) Before performing the vibration suppression operation, please set the inertia ratio and gain parameters correctly, otherwise it can not be controlled properly.

6.7.2 Operation tools

Adjustment mode	Operation tools	Control mode	Operation steps	Limitation
Adaptive mode	XinJeServo Mechanical Characteristic Analysis	Position mode	6.7.4 Vibration Suppression (PC Software)	All versions of PC software support
Auto-tuning mode	Panel vibration suppression		6.7.3 Vibration Suppression (Panel)	Driver firmware requires version 3700 or higher
	XinJeServo Mechanical Characteristic Analysis		6.7.4 Vibration Suppression (PC Software)	All versions of PC software support
Auto-tuning /adaptive mode	Panel vibration suppression		6.7.7 vibration suppression (easyFFT)	Driver firmware requires version 3730 or higher

Note: The firmware version of the drive is viewed through U2-07.

6.7.3 Vibration suppression (panel)



There are two modes of panel vibration suppression, mode 1(vib-1) and mode 2(vib-2).

■ Difference between Two Kinds of Vibration Suppression

Mode	Display	Changed parameters
Mode 1	vib-1	Only the parameters related to vibration suppression will be changed.
Mode 2	Vib-2	It will change the parameters of vibration suppression and the gain of speed loop.

The operation steps:

1. Enter F0-10 in auto-tuning mode, the panel shows vib-1 or enter F0-11, the panel shows vib-2;

 or
 

2. Press ENTER, panel shows Son and flashes, turn on the enabler by manual;

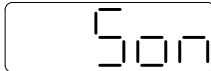

3. After turn on the enabler, panel shows tune and flickers, enter auto-tuning process;



4. The upper device starts to send pulses, then it will show done and flicker



5. Press STA/ESC to exit
6. Vibration suppression parameters are automatically written into the second and first notches (the second notches are preferred when there is only one vibration point). The related parameters are detailed in 6.7.7 notch filter.

■ Fault alarm of panel in vibration suppression process

Error code	Meaning	Reasons
Err-1	Failure to search for optimal gain	Too large inertia ratio; too weak rigidity of mechanism
Err-2	(1) Overrun/alarm occurs during auto-tuning (2) External instruction auto-tuning/Vibration Suppression Mode: Servo turns off the Enabler in auto-tuning process	Please make sure that there is no overrun and alarm before auto-tuning. Make sure that the enabler is not turned off when auto-tuning
Err-3	Non-position control mode	please auto-tune in position mode
Err-4	Not turn off the adaptive function	please set P2-01.0 to 0, then auto-tune
Err-7	Driver alarm in auto-tuning process	driver alarmed
Err-8	Positioning Completion Signal Instability	Short instruction interval

6.7.4 Vibration suppression (PC software)

1. open XinJeServo software, click mechanical properties;
2. click measure;

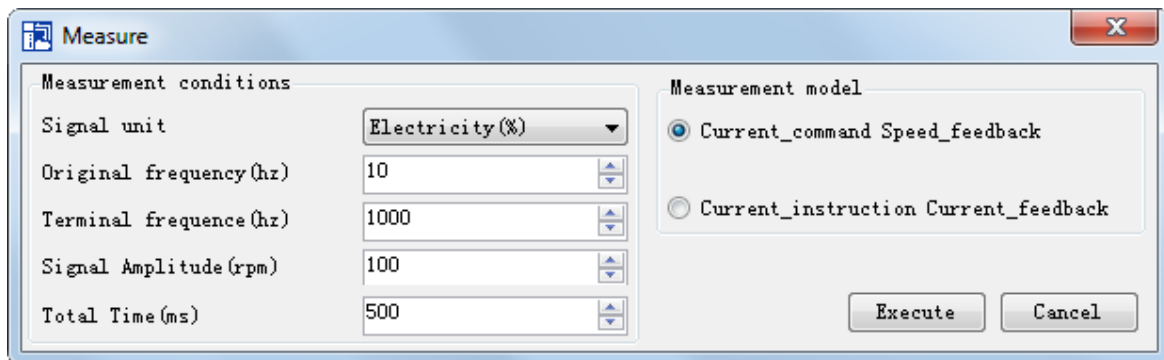

3. set the measure conditions, then click execute;
4. select amplitude and phase;

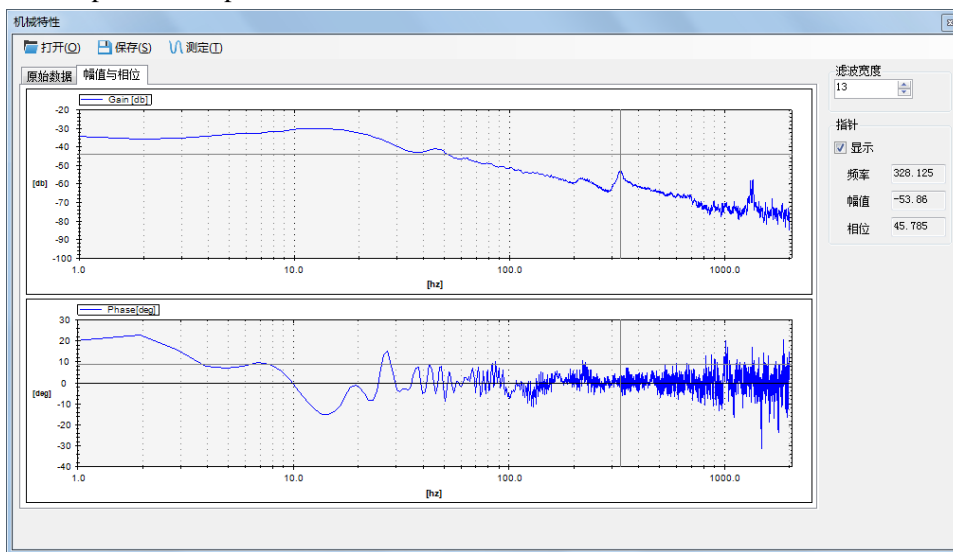

5. set the filter width (to see resonance frequencies clearly), find the resonance frequency;
6. Notch parameters need to be set manually. Refer to 6.7.7 notch filter for details.

As an example, through the analysis of mechanical characteristics, the resonance frequency is 328 Hz, and the third notch filter can be used. The parameters are as follows:

Note: In both adaptive and auto-tuning modes, if mechanical characteristic analysis is used, the notch can be set manually. If there are multiple resonance points, the third to fifth notch can be configured in turn.

6.7.5 Vibration suppression (manual setting)

If the resonance frequency of the mechanical system is known, the vibration can be eliminated by setting the vibration frequency manually. Please configure the third to fifth notches. The related parameters are detailed in 6.7.7 notch filter.

6.7.6 Vibration suppression (quick FFT)

This function can analyze the mechanical characteristics through the parameter F0-12 on the servo operate panel, find out the mechanical resonance frequency and realize the vibration suppression. The complete operation process is shown in the figure below:

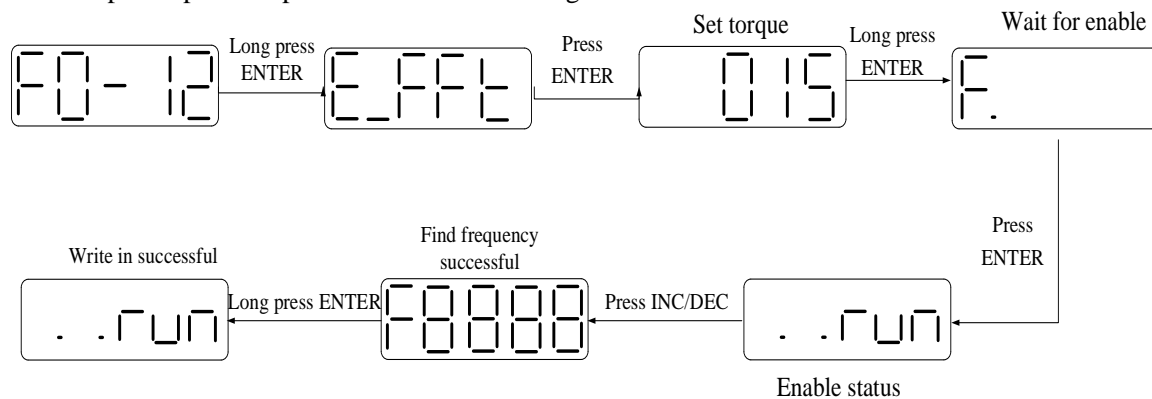

The operation steps are described as follows:

1. F0-12, long press **【ENTER】** to enter quick FFT function, it will show “E_FFt”.

E_FFt

2. Press **【ENTER】** to enter torque setting interface, it will show the current setting torque, which is the value of P6-89. Press **【INC】**, **【DEC】** to increase or decrease torque command. When increasing the torque command, it is recommended to increase it a little bit to avoid severe vibration of the equipment.

015

3. After setting the torque command, long press **【ENTER】**, enter “read to enable” status, it will show ‘F’.

F.

4. Press **【ENTER】**, enable, it will show “..run”.

..run

5. Press **【INC】**, **【DEC】** to run forward or reverse and find the resonance frequency. “E_FFt” will shine on the panel when operation. If the resonance frequency is found, it will show “Fxxxx”, “xxxx” is the resonance frequency. If failed, it will show “F----”.

F0000

6. Whatever it shown “Fxxxx” or “F----”, press **【INC】**, **【DEC】** can find the resonance frequency again. If the resonance frequency is found, long press **【ENTER】** to set the resonance frequency in the notch filter of servo driver.

Note: for above each step, press STA/ESC can return to the last step or exit.

6.7.7 Notch filter

Notch filter can suppress mechanical resonance by reducing the gain at a specific frequency. After the notch filter is set correctly, the vibration can be effectively suppressed and the servo gain can be continuously increased.

The principle diagram of notch filter is as follows:

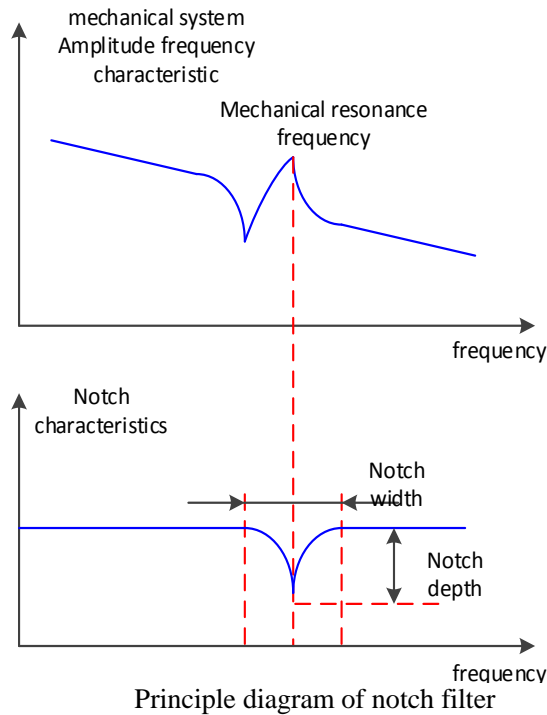

The servo driver has five sets of notch filters, each with three parameters, notch frequency, notch attenuation and notch bandwidth. The first and second notches are set automatically, and the third, fourth and fifth are set manually.

The torque instruction filter and notch filter are in series in the system. As shown in the figure below, the switch of the notch filter is controlled by P2-69 and P2-70.

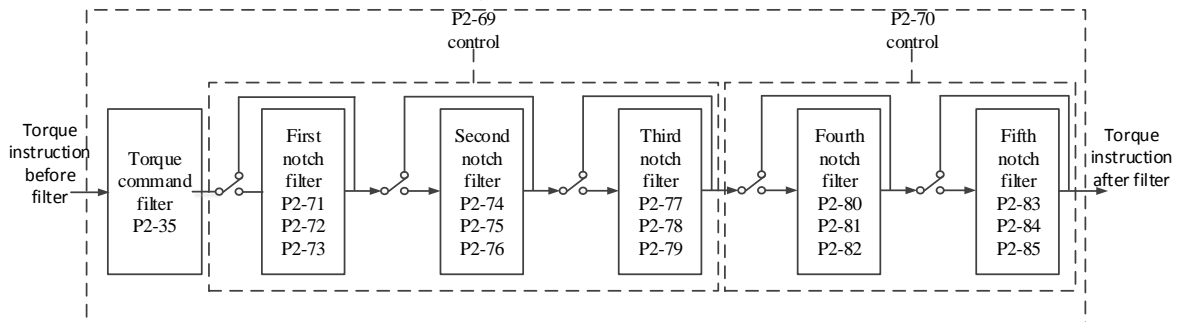

Parameter	Meaning	Default setting	Change	Effective
P2-69	n.□□□0	First notch off	Anytime	At once
	n.□□□1	First notch on		
	n.□□0□	Second notch off	Anytime	At once
	n.□□1□	Second notch on		

	n.0□□□	Third notch off	n.0□□□	Anytime	At once
	n.1□□□	Third notch on			
P2-70	n.□□□0	Fourth notch off	n.□□□0	Anytime	At once
	n.□□□1	Fourth notch on			
	n.□□0□	Fifth notch off	n.□□0□	Anytime	At once
	n.□□1□	Fifth notch on			

Parameter	Meaning	Default setting	Unit	Range	Change	Effective
P2-71	First notch frequency	5000	Hz	50~5000	Anytime	At once
P2-72	First notch attenuation	70	0.1dB	50~1000	Anytime	At once
P2-73	First notch bandwidth	0	Hz	0~1000	Anytime	At once
P2-74	Second notch frequency	5000	Hz	50~5000	Anytime	At once
P2-75	Second notch attenuation	70	0.1dB	50~1000	Anytime	At once
P2-76	Second notch bandwidth	0	Hz	0~1000	Anytime	At once
P2-77	Third notch frequency	5000	Hz	50~5000	Anytime	At once
P2-78	Third notch attenuation	70	0.1dB	50~1000	Anytime	At once
P2-79	Third notch bandwidth	0	Hz	0~1000	Anytime	At once
P2-80	Fourth notch frequency	5000	Hz	50~5000	Anytime	At once
P2-81	Fourth notch attenuation	70	0.1dB	50~1000	Anytime	At once
P2-82	Fourth notch bandwidth	0	Hz	0~1000	Anytime	At once
P2-83	Fifth notch frequency	5000	Hz	50~5000	Anytime	At once
P2-84	Fifth notch attenuation	70	0.1dB	50~1000	Anytime	At once
P2-85	Fifth notch bandwidth	0	Hz	0~1000	Anytime	At once

Note:

1. In the adaptive mode, if the vibration is detected, the second notch filter will be automatically configured.
2. In the auto-tuning mode, the second and first notches will be automatically configured if the vibration is detected (the second notches will be preferentially opened when there is only one vibration point).
3. Whether in self-adaptive or auto-tuning mode, if the mechanical characteristic analysis is sued, it belongs to manual setting of notches, please configure the third to fifth notches.

6.8 Gain adjustment

6.8.1 Load shaking

The following causes cause load wobble:

1. The instruction is not smooth enough when the load inertia is too large.

Countermeasure:

- (1) Use position instruction smoothing filter P1-25;
- (2) Optimizing the instructions of the upper device to reduce the acceleration of the instructions;
- (3) Replace the motor with greater inertia.

2. Servo gain is too small, resulting in insufficient rigidity

Countermeasure:

- (1) Increase the gain parameters and rigidity to enhance the anti-disturbance ability.

3. Insufficient rigidity of mechanism and equipment sloshing

Countermeasure:

- (1) Reducing gain parameters;
- (2) Optimize the instructions of the upper device and reduce the acceleration of the instructions.

6.8.2 Vibration

The following causes cause machine vibration:

- (1) Vibration due to inappropriate servo gain

Countermeasure: Reduce gain

- (2) Mechanical resonance point

Countermeasure: Setting notch parameters manually or through mechanical characteristic analysis

6.8.3 Noise

In adaptive mode:

- (1) Inappropriate servo gain

Countermeasure: Reduce the adaptive control bandwidth (P2-19).

In auto-tuning mode:

- (1) Inappropriate servo gain

Countermeasure: Under the mode of rapid adjustment, reduce the rigidity level.

Automatic Adjustment Mode: Reducing Model Loop Gain P2-49

- (1) Noise due to mechanical resonance

Countermeasure: Refer to 6.8.2 vibration.

7 Alarm

7.1 Alarm code list

Historical record: "√" means that historical alarms can be recorded; "○" is not recorded;

The column that can be cleared: "√" represents the alarm that can be cleared; "○" represents the alarm that cannot be cleared.

Alarm code	Code	Explanation	Property			Servo status when alarming	
			Historical records	Can be cleared	Whether power on is needed to clear the alarm		
EEEE	1	EEEE1	Communication error between panel and CPU	○	○	No	Servo run
	2	EEEE2			○	No	Servo run
	3	EEEE3			○	No	Servo run
	4	EEEE4			○	No	Servo run
01	0	E-010	Firmware version mismatch	○	○	Yes	Servo run
	3	E-013	FPGA Loading Error	○	○	Yes	Servo run
	5	E-015	Program running error	○	○	Yes	Servo run
	6	E-016	Processor Running Error	○	○	No	Servo run
	7	E-017	Processor Running Timeout	○	○	Yes	Servo run
	9	E-019	System password error	○	○	Yes	Servo run
02	0	E-020	Parameter loading error	○	○	Yes	Servo run
	1	E-021	Parameter range beyond limit	○	√	No	Servo run
	2	E-022	Parameter conflict	√	√	No	Servo run
	3	E-023	Sampling channel setting error	○	○	Yes	Servo run
	4	E-024	parameter lost	√	√	No	Servo run
	5	E-025	Erase FLASH error	√	√	No	Servo run
	6	E-026	Initialization FLASH error	√	√	No	Servo run
	8	E-028	EEPROM write in error	√	√	No	Servo run
03	0	E-030	Bus voltage overvoltage	√	√	No	Servo off
04	0	E-040	Bus voltage under voltage ① Low grid voltage	√	√	No	Servo run
			Bus voltage under voltage ② Bus voltage undervoltage caused by power failure of driver	○	√	No	Servo off
	1	E-041	Driver power down	○	√	No	Servo run
	3	E-043	Bus Voltage Charging Failure	√	√	No	Servo off
	4	E-044	Three phase voltage input phase loss	√	√	No	Servo off
06	0	E-060	Module temperature too high	√	√	No	Servo run
	1	E-061	Motor overheating	√	√	Yes	Servo run
	3	E-063	Thermocouple disconnection alarm	√	√	No	Servo run
08	0	E-080	Overspeed alarm	√	√	No	Servo off
09	2	E-092	Analog Tref Zero-Calibration Over limit	√	√	No	Servo run
	3	E-093	Analog Vref Zero-Calibration Over limit	√	√	No	Servo run
10	0	E-100	Excessive position deviation	√	√	No	Servo run

11	0	E-110	External UVW Short Circuit Discovered in Self-Inspection	√	√	No	Servo off
13	0	E-150	Power cable disconnection	√	√	No	Servo off
16	1	E-161	Driver thermal power overload	√	√	No	
	5	E-165	Anti-blocking alarm	√	√	No	Servo run
20	0	E-200	Regenerative resistance overload	√	√	No	Servo run
22	0	E-220	Communication error of absolute servo encoder	√	√	No	Servo off
	1	E-221	Too many CRC errors in encoder communication	√	√	No	Servo off
	2	E-222	Absolute value servo encoder battery low voltage alarm	√	√	No	Servo off
	3	E-223	Absolute value servo encoder data access alarm	√	√	No	Servo off
	7	E-227	Power on encoder multi-turn signal data error	√	√	No	Servo off
	8	E-228	Absolute Servo Encoder Value Overflow	√	√	No	Servo off
23	6	E-236	The feedback position deviation between motor encoder and external displacement sensor is too large	√	√	Yes	Servo off
	7	E-237	Fully closed-loop motor encoder and external grating ruler counter direction reverse	√	√	Yes	Servo off
	8	E-238	Full closed loop external grating scale speed overrun	√	√	Yes	Servo off
24	0	E-240	Timing error in fetching encoder position data	√	√	No	Servo off
	1	E-241	Encoder reponse data is error code	√	√	No	Servo off
26	0	E-260	Over range alarm	√	√	No	Servo run
	1	E-261	Overrun signal connection error	√	√	No	Servo run
	2	E-262	Control stop timeout	√	√	No	Servo off
	4	E-264	Excessive vibration	√	√	No	Servo run
	5	E-265	Motor vibration too large	√	√	No	Servo run
28	0	E-280	Failed to access motor parameters	√	○	Yes	Servo off
	1	E-281	Error writing data to encoder EEPROM	√	○	Yes	Servo off
31	0	E-310	Motor power mismatch	○	○	Yes	Servo off
	1	E-311	Motor code missing	√	○	Yes	Servo off
	1	E-312	Reading motor parameter is damaged	√	○	Yes	Servo off
	3	E-313	Encoder software version mismatch	√	○	Yes	Servo off
	4	E-314	Encoder software version not supported	√	○	Yes	Servo off
	5	E-315	Unable to read valid motor parameters	√	○	Yes	Servo off
	6	E-316	Reading motor code is inconsistent with setting code	√	○	Yes	Servo off

7.2 Analysis of alarm types

DS5 alarm code format is E-XX□, “XX” means main type, “□” means sub-type.

Type	Code	Description	Reasons	Solutions	
EE EE	1	EEEE 1	Communication error between panel and CPU	(1) Voltage fluctuation of power supply is large, and low voltage leads to failure of panel refresh; (2) Damage of panel program	(1) Stable power supply to ensure the stability of power supply voltage. (2) after repower on the driver, if the alarm cannot be removed, please contact the agent or the manufacturer.
	2	EEEE 2			
	3	EEEE 3			
	4	EEEE 4			
01	0	E-010	Firmware version mismatch	Downloaded firmware version error	Please contact the agent or the manufacturer
	3	E-013	FPGA loading error	①program damaged ②device damaged	Please contact the agent or the manufacturer
	4	E-014	FPGA Access error	(1) Program damage (2) Device damage (3) serious external interference	Please contact the agent or the manufacturer
	5	E-015	Program running error	Program damage	Please contact the agent or the manufacturer
	6	E-016	Hardware error	①program damaged ②hardware damaged ③Excessive intensity of external interference	① Check the input voltage, whether the input phase is missing or the supply voltage is too low ② Contact agent or manufacturer
	7	E-017	Processor Running Timeout	Program damage	Please contact the agent or the manufacturer
	9	E-019	System password error	Program damage	Please contact the agent or the manufacturer
02	0	E-020	Parameter loading error	Failure of parameter self-checking	Re-energizing can restore default parameters, if there are repeated problems, please contact the agent or manufacturer.
	1	E-021	Parameter range beyond limit	Setting values are not within the prescribed range	Check parameters and reset them
	2	E-022	Parameter conflict	Conflict of TREF or VREF Function Settings	P0-01=4, P3-00 set to 1 will alarm
	3	E-023	Sampling channel setting error	Error setting of custom output trigger channel or data monitoring channel	Check that the settings are correct
	4	E-024	parameter lost	Low voltage of power grid	(1) If it is single-phase 220V power supply, please connect L1 and L3. (2) show E-024 immediately after power failure (3) Resetting parameters
	5	E-025	Erase FLASH error	Abnormal parameter preservation during power failure	please contact the agent or the manufacturer
6	E-026	Initialization FLASH error	Power supply instability of FLASH chip	please contact the agent or the manufacturer	

	8	E-028	EEPROM write in error	Voltage instability or chip abnormality	Please contact the agent or the manufacturer
03	0	E-030	Bus voltage U0-05 is higher than the actual preset threshold, 220V Power Supply Machine (U0-05 \geq 402V) 380V Power Supply Machine (U0-05 \geq 780V)	High voltage of power grid	Check the fluctuation of power grid, 220V driver normal voltage range 200V ~ 240V, 380V driver normal voltage range 360V ~ 420V. If the voltage fluctuation is large, it is recommended to use the correct voltage source and regulator.
				Excessive load moment of inertia (insufficient regeneration capacity)	(1) connect external regenerative resistor, (220V: bus voltage U0-05 = 392 discharge starts, U-05 = 377 discharge ends; 380V: U-05 = 750 discharge starts, U-05 = 720 discharge ends;) (2) Increasing Acceleration and Deceleration Time (3) Reducing load inertia (4) Reduce start-stop frequency (5) Replacement of larger power drivers and motors
				Brake resistance damage or excessive resistance value	Check the regenerative resistor and replace the external resistor with the appropriate resistance value. See chapter 1.4.1 for the selection of the external resistor.
				Acceleration and deceleration time is too short	Extending Acceleration and Deceleration Time
				Hardware Fault of Driver Internal Sampling Circuit	The AC gear of the multimeter measures the input value of the servo LN (R/S/T), which is 220V \pm 10% of the normal value. If the power supply voltage is more than 220V+10% (380V+10%), check the power supply voltage; if the power supply voltage is normal, then the servo BB state, monitor U0-05, the voltage measured by the multimeter * 1.414 < U0-05 (within 10V error), then the servo driver is faulty and needs to be sent back for repair.
04	0	E-040	Bus voltage U0-05 is lower than the actual preset threshold. 220V power supply machine (U0-05 \leq 150V) 380V power supply machine (U0-05 \leq 300V)	low voltage of power grid when normal power on	(1) Check the fluctuation of power grid. The normal voltage range of 220V driver is 200V~240V. If the voltage fluctuation is large, the voltage regulator is recommended. (2) Replacement of larger capacity transformers
				Instantaneous power failure	Re-energize after voltage stabilization
				Hardware Fault of Driver Internal Sampling Circuit	The AC gear of the multimeter measures the input value of the servo LN (R/S/T), which is 220V \pm 10% of the normal value. If <

					220V + 10% (380V + 10%), then check the supply voltage; if the supply voltage is normal, then servo BB state, monitoring U0-05, multimeter measurement voltage * 1.414 > U0-05 (error within 10V), then the servo driver is faulty and needs to be sent back for repair
	1	E-041	Driver power down	Driver power off	Check the power supply
	3	E-043	Bus Voltage Charging Failure	low voltage of power grid when normal power on	low voltage of power grid when normal power on
				Hardware damage	When the driver is on, please pay attention to whether there is relay actuation sound
	4	E-044	Three phase voltage input phase loss	Three phase input power supply is lack of phase	Check the power supply
06	0	E-060	Module temperature is too high (Module temperature U-06 $\geq 90^{\circ}\text{C}$ alarm, U-06 $\geq 70^{\circ}\text{C}$ Warning)	Running under heavy load for a long time	Re-consider the capacity of the motor, monitor the U0-02 torque during operation, whether it is in the value of more than 100 for a long time, if yes, please chose the large-capacity motor or load reduction.
				Excessive ambient temperature	(1) Enhance ventilation measures to reduce ambient temperature; (2) Check whether the fan rotates when the servo is enabled; when the module temperature U-06 $\geq 45^{\circ}\text{C}$, the fan opens.
				Fan damage	Replace the fan
	1	E-061	Motor overheat	Alarm when motor temperature is higher than 95°C	① Check whether the motor fan is abnormal ② Contact the manufacturer for technical support
	3	E-063	Thermocouple disconnection alarm	① The motor thermocouple of 11kw and above power is disconnected ② False opening detection and disconnection alarm of motor below 11kw	Check the external thermocouple connection; Shield thermocouple disconnection alarm: P0-69.1 = 1
08	0	E-080	Overspeed (actual speed \geq P3-21/P3-22) The maximum forward speed is P3-21 and the maximum reverse speed is P3-22.	Motor code not match	Check if the driver P0-33 is identical with the motor code of the motor label (the number after MOTOR CODE), if not, please change to the same one, then power on again.
				UVW wiring error	Inspection of motor UVW wiring, need to be connected in phase sequence.
				Motor speed too fast	(1) The maximum speed limit value P3-21/P3-22 was reduced. (2) To confirm whether the external force makes the motor rotate too fast, whether the pulse

					input frequency is too high, and whether the electronic gear ratio is too large.
				Encoder fault	(1) Check the encoder cable or change a new one (2) Set the servo driver to BB state and the driver to U-10. Rotate the motor shaft slowly by hand to see if the value of U-10 changes normally, increasing in one direction and decreasing in one direction (0-9999 cycle display).
09	2	E-092	Analog Tref Zero-Calibration Over limit	Analog Calibration Error	Zero Operation Please correct zero without analog voltage
	3	E-093	Analog Vref Zero-Calibration Over limit	Analog Calibration Error	Zero Operation Please correct zero without analog voltage
10	0	E-100	Position offset too large	In position control, the difference between the given position and the actual position exceeds the limit value.	(1) Observe whether the motor is blocked or not. (2) Reducing the given speed of position; (3) Increase the deviation pulse limit P0-23.
11	0	E-110	External UVW Short Circuit Discovered in Self-Inspection	Not match the motor code	Check if the driver P0-33 is identical with the motor code of the motor label (the number after MOTOR CODE), if not, please change to the same one, then power on again.
				UVW wiring error	Inspection of motor UVW wiring, need to be in phase sequence (brown U, black V, blue W)
				Driver UVW Output Short Circuit or Motor Failure	(1) Measure whether the UVW phase resistance of the motor is balanced. If the phase resistance is unbalanced, replace the motor. (2) Measure whether there is short circuit between UVW and PE of the motor. If there is short circuit, replace the motor. (3) Measure the driver side UVW output through multimeter (diode gear), black pen P+, red pen to measure UVW; red pen P-, black pen to measure UVW; if anyone is 0 in 6 groups of value, replace the driver.
				Load part is blocked	It is suggested that the motor should be operated on an empty shaft to eliminate the load problem.
				High-speed start-stop instantaneous alarm	Increasing Acceleration and Deceleration Time
				Encoder problem	(1) Check the encoder cable or change a new one (2) Set the servo driver to BB state and the driver to U-10.

					Rotate the motor shaft slowly by hand to see if the value of U-10 changes normally, increasing in one direction and decreasing in one direction (0-9999 cycle display).
13	0	E-150	Power cable disconnection	Any phase in UVW of driver, cable or motor broken	Disconnect the power supply of the driver and check the connection of the power cable. It is suggested that the multimeter be used to test the condition. After eliminating the errors, the driver should be re-energized.
16	1	E-161	Driver thermal power overload	Not match the motor code	Check if the driver U3-00 is identical with the motor code of the motor label (the number after MOTOR CODE), if not, please change to the same one, then power on again.
				Overload, the actual operating torque exceeds the rated torque, and continuous operation for a long time. (Monitor U0-02 to check the actual operating torque. If the motor is in normal operation, it will not jam or jitter. If the U0-02 is longer than 100, it will be considered improper selection of the motor.)	Increase the capacity of drivers and motors. Extend the acceleration and deceleration time and reduce the load. Monitor the U-00, whether it is running over speed.
				Mechanisms are impacted, suddenly weighted and distorted.	Eliminate mechanical distortion. Reduce load
				Motor action when motor brake is not opened	Measure the voltage of the brake terminal and decide to open the brake. It is suggested to use servo BK signal to control the brake lock. If it is not servo control, attention must be paid to the timing of brake opening and motor action.
				Wrong wiring of encoder cable, power cable or broken wire or loose pin of connector plug	Check the UVW connection of power cable to see if there is any phase sequence error. The multimeter is used to measure whether all the encoder cable are on. Check whether the plug is loose, for machine vibration, whether the plug has shrinkage pin, virtual welding, damage.
In multiple mechanical wirings, incorrect connection of motor cable to other shafts leads to incorrect	Detection of servo wiring, the motor cable, encoder cable are correctly connected to the corresponding shaft.				

				wiring.	
				Poor gain adjustment results in motor vibration, back and forth swing and abnormal noise.	Readjustment of gain parameters
				Driver or motor hardware failure;	There are servo cross test or motor empty shaft on site, F1-01 trial operation, F1-00 jog run can not rotate uniformly; Replace the new driver or motor and send the malfunction machine back to the manufacturer for repair.
16	5	E-165	Anti-blocking alarm Judging that the current motor output torque is greater than P3-28/P3-29 (internal forward/reverse torque limit), and the time reaches P0-74 (unit ms), and the speed is lower than P0-75 (unit 1 rpm).	(1) Machinery is impacted, suddenly becomes heavier and distorted; (2) When the brake of the motor is not opened, the motor moves; (3) The parameter setting is unreasonable.	(1) Eliminate the factors of mechanical distortion. Reduce load (2) Measure the voltage of the brake terminal and determine the opening of the brake; It is suggested to use servo BK brake signal to control the brake lock. If it is not servo control, attention must be paid to the timing of brake opening and motor action. (3) Monitor the actual output torque range of U0-02 and check whether the setting of P3-28/29 torque limit is reasonable. (After version 3760, the output torque limit setting parameters of anti locked rotor alarm are P3-38 and P3-39)
20	0	E-200	Regenerative resistance overload	High Voltage Fluctuation in Power Grid	Stable the input voltage
				Selection of regenerative resistance is too small	Replacement of higher power regenerative resistors (refer to chapter 1.4.1)
				Acceleration and deceleration time is too short	Extending Acceleration and Deceleration Time
				Hardware damage	The AC gear of the multimeter measures the input value of the servo LN (R/S/T), which is 220V ± 10% of the normal value. If the power supply voltage is more than 220V+10% (380V+10%), check the power supply voltage; if the power supply voltage is normal, then in servo BB state, monitor U0-05, the voltage measured by the multimeter * 1.414 < U0-05 (within 10V error), then the servo driver is faulty and needs to be sent back for repair.
22	0	E-220	Communication error of absolute	Motor matching error	Check if the motor matches correctly

		servo encoder	Unconnected encoder cable or poor contact	Check whether the value of U0-54 increases rapidly. If yes, the encoder circuit is disconnected. Disconnect the power supply of the driver, check the connection of the encoder cable, if there is cable loosening, it is recommended to use the multimeter to test the conduction condition; after eliminating errors, power on again Hot plugging is strictly prohibited, and special cables are required for tank chains.
			Received encoder data errors, and the number of errors exceeds the number of error retries of encoder registers P0-56	Check whether the value of U0-79 and U0-54 increase. If yes, the encoder is interfered. Encoder wire and strong power do not have the same pipeline wiring; install filter on servo driver power input side; encoder wire sleeves magnetic ring; shut down welding machine type of equipment with large interference
1	E-221	Too many CRC errors in encoder communication	The received encoder data is wrong and the number of errors exceeds the value in encoder error retry number register P0-56	Encoder interfered, isolate interference source
2	E-222	Absolute value servo encoder battery low voltage alarm (can shield this alarm)	Battery Voltage in Battery Box of Encoder cable is less than 2.75V	Please replace the battery while keeping the power supply ON of the servo driver in order to avoid the error of encoder position information. Battery specification: No.5 battery, 3.6V (model CP-B-BATT, CPT-B-BATT)
			Power on alarm for new machine	(1) When the absolute value motor is powered off, the memory position depends on the battery on the encoder cable. Once the encoder cable and the motor are disconnected, the power supply can not be carried out, which will lead to the loss of the current position of the motor, it will alarm 222. Please set F0-00=1 to clear the alarm, it can be used normally. (2) The alarm can be shielded by using F0-79. When P0-79 is set to 1, it will be used as a single-loop absolute value motor, and the current position will not be remembered when power off.
3	E-223	Data access alarm of absolute value servo encoder	Encoder cable with battery box is not used for multi-turn absolute motor	① Please use encoder cable with battery box; ② Power off and power on again

			Generally, it is the problem of the encoder itself, or the power supply of the encoder is unstable	(the driver panel shall be completely off). If the alarm cannot be removed, please contact the agent or manufacturer
			Abnormal power on of main control chip of multi-turn absolute value servo encoder	
			ADC sampling is out of range, some resistance and capacitance devices have problems or the signal consistency of magnetic sensor is poor	

Type	Code	Description	Reasons	Solutions
22	7	E-227 Power on encoder multi turn signal data error	Generally, it is the problem of the encoder itself, or the power supply of the encoder is unstable	In the case of no battery, unplugging the encoder cable may cause this alarm.
	8	E-228 Absolute value servo encoder value overflow	The motor runs in one direction continuously, the encoder data value is too large, overflow	① Set F1-06 = 1, clear the absolute encoder's multiple turns; ② Set P0-79 = 2, the alarm can be shielded.
23	6	E-236 The error between motor encoder feedback and displacement sensor feedback (user command resolution) exceeds the setting value of P9-02	The error between motor encoder feedback and grating encoder feedback (user command resolution) exceeds the setting value of P9-02	① Mechanism error. The motor outputs the shaft position directly and reaches the moving platform through the mechanism. The feedback of the grating ruler is directly from the moving platform, and there will be errors in it after passing through the synchronous belt or lead screw ② Grating ruler installation is not parallel ③ Set P9-05 to P9-08 reasonably
	7	E-237 Fully closed-loop motor encoder and external grating ruler counter direction reverse	When P9-02 is set to 0, the grating ruler is broken or not connected correctly.	Check the grating ruler and power on again
	8	E-238 Full closed loop external grating scale speed overrun	The error between the feedback speed of motor encoder and that of grating ruler exceeds the set value of P9-04.	Check that the correct P9-05 ~ P9-08 is selected for the mechanism and power on again.
24	0	E-240 Timing error in fetching encoder position data	① The number of consecutive errors in encoder data update sequence is greater than the value in P0-68 ② CPU timer fluctuates	① Restart driver ② Check the arrangement of transmission cables to ensure that the strong and weak current are wired separately. ③ High current equipment is supplied separately. ④ The grounding is good.
	1	E-241 Encoder responding data	The received encoder data is wrong and the	① Check the arrangement of transmission cables to ensure that

			scrambling	number of errors exceeds the value in encoder error retry number register P0-56	the strong and weak current are wired separately. ② High current equipment is supplied separately. ③ The grounding is good.
26	0	E-260	Over range alarm	Overrun signal was detected and the overrun processing mode was configured to alarm	If you do not want to alarm immediately when the overrun occurs, you can change the overrun signal processing mode.
	1	E-261	Overrun signal connection error	(1) When the motor is in forward rotation, it encounters reverse overrun signal. (2) When the motor is in reverse rotation, it encounters forward overrun signal.	Check over-run signal connection and over-run terminal allocation.
	2	E-262	Control stop timeout	(1) Excessive inertia (2) Stop timeouts too short (3) The setting of braking torque is too small.	(1) Reduce inertia or use brake motor; (2) Increase the stop timeout time P0-30; (3) Increase braking torque P3-32.
	4	E-264	Excessive vibration	(1) Oscillation caused by external forces (2) Load inertia is large and the setting of load inertia ratio is wrong or the gain is too small, which leads to the oscillation of positioning.	(1) Check the source of external force to see if there are any problems in mechanical installation; (2) Increase the servo gain to improve the anti-disturbance ability; (3) Acquisition speed curve analysis; When the first three peaks are converged after pulse instruction completed ($0.8 * \text{first peak} > \text{second peak} $ and $0.8 * \text{second peak} > \text{third peak} $), the driver should not alarm, which can adjust the relevant threshold. When the first three peaks speed are not less than 300 rpm for three consecutive times after the completion of the pulse instruction, the driver will alarm. (4) Contact manufacturers for technical support
	5	E-265	Excessive motor vibration	Mechanical vibration	Check the motor installation
28	0	E-280	Failed to read motor parameters	Request to read EEPROM failed	On the premise that the driver and motor are matched and can be used together, read the alarm shielding position of motor parameters through P0-53, and set the motor code of P0-33 correctly
	1	E-281	Error writing data to encoder EEPROM	Request to write EEPROM failed	On the premise that the driver and motor are matched and can be used together, read the alarm shielding position of motor parameters through P0-53, and set the motor code of P0-33 correctly

31	0	E-310	Power mismatch between driver and motor	Such as 750W driver with 200W motor	Match the correct motor and driver, and use it after setting the P0-33 motor code correctly
31	1	E-311	When the motor code is read automatically, the motor parameter is 0, and the driver P0-33 = 0	Motor code not set	On the premise that the driver and motor are matched and can be used together, read the alarm shielding position of motor parameters through P0-53, and set the motor code of P0-33 correctly
	2	E-312	Reading motor parameter is damaged	Parameter CRC verification failed	On the premise that the driver and motor are matched and can be used together, read the alarm shielding position of motor parameters through P0-53, and set the motor code of P0-33 correctly
	3	E-313	Encoder software version mismatch	Encoder software version mismatch	① Update driver firmware to maximize current motor parameter performance ② Read the alarm shielding position of motor parameters through p0-53, and set the motor code of P0-33 correctly. At this time, the motor parameters are in the driver, which can work normally, but may affect some performance
	4	E-314	Motor code does not match software version	Encoder hardware version is higher than driver firmware version	Contact the manufacturer's technical support to update the driver firmware
	5	E-315	When the motor code is read automatically, the motor parameter is 0, and the driver P0-33 \neq 0	Read the motor code is 0	On the premise that the driver and motor are matched and can be used together, read the alarm shielding position of motor parameters through P0-53, and set the motor code of P0-33 correctly
	6	E-316	Auto-read code error	The auto read motor code is inconsistent with the motor code set in P0-33	Check U3-00 and motor label. ① If the two values are the same, change P0-33 motor code or set P0-33 to 0 to read motor code automatically; ② If the two values are different, contact the manufacturer for technical support

8 Modbus-RTU communication

The company provides users with the general RS485 communication interface in industrial control. The communication protocol adopts MODBUS standard communication protocol, and the servo can be used as the slave station to communicate with the master device (such as PLC controller and PC) with the same communication interface and the same communication protocol, and the HMI can also be connected through the communication interface. Realize the remote operation of the frequency converter by the user.

This series of servo Modbus communication protocol supports RTU mode. The following is a detailed description of the communication protocol.

8.1 Communication wiring

1. RS-232 communication wiring

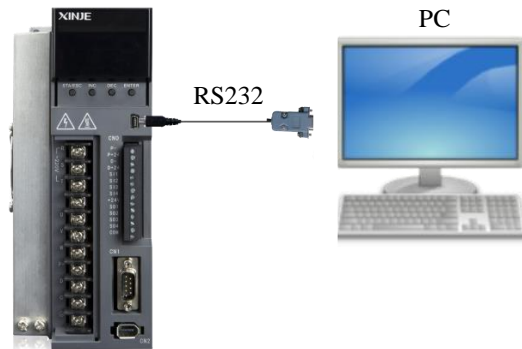

2. RS-485 communication wiring

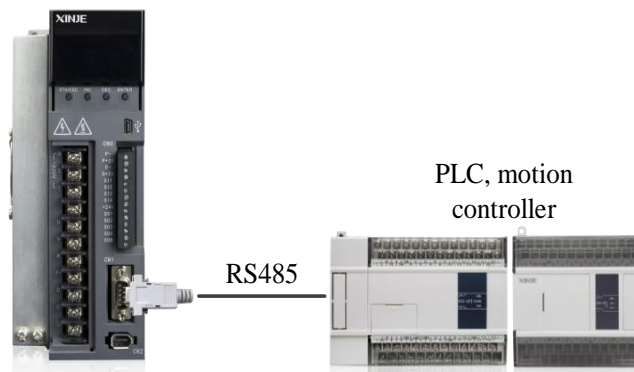

3. PLC and servo communication (Servo driver and motor are all well grounded)

(1) Best recommendation: hand in hand mode

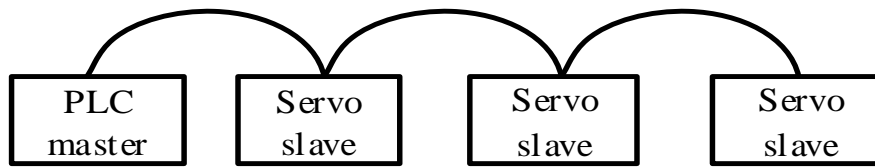

(2) General recommendation: branch structure

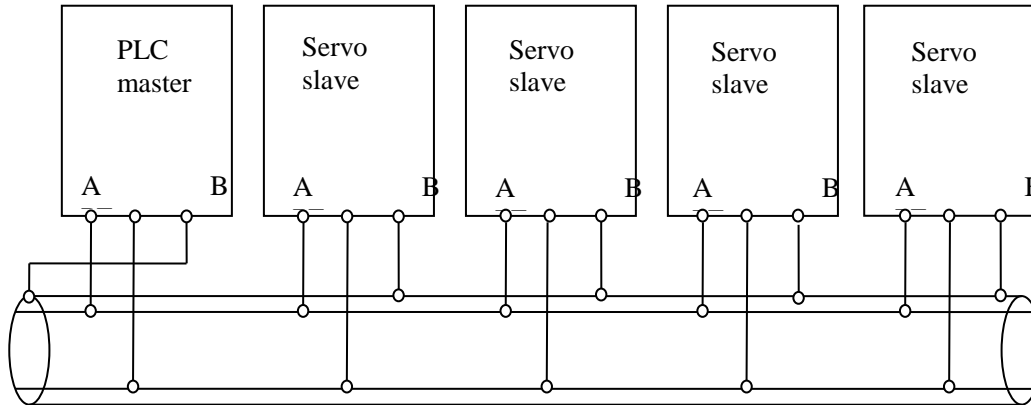

(3) Not recommended: star connection

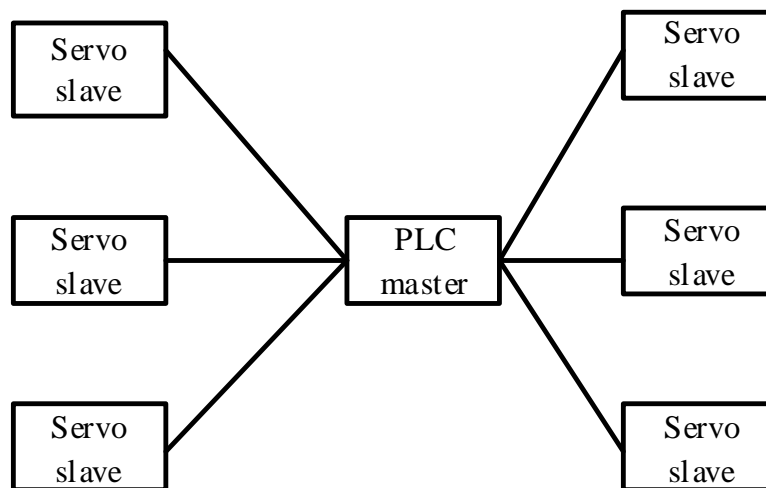

8.2 Communication parameters

1. RS485 communication parameters

Parameter	Meaning	Default setting	Range	Modify	Effective
P7-00	RS485 station number	1	0~100	Servo bb	At once

Parameter	Function	Unit	Default setting	Suitable mode	Modify	Effective
P7-01	Communication setting	-	n.2206	All	Servo bb	At once
	Setting		Default setting	Range		
	n.□xxx	Parity bit	0	0: no parity 1: odd 2: even		
	n.x□xx	Stop bit	0	0: 2-bit 2: 1 bit		
	n.xx□□	Baud rate	06	00: 300 01: 600 02: 1200 03: 2400 04: 4800 05: 9600 06: 19200 07: 38400 08: 57600 09: 115200 0A: 192000 0B: 256000 0C: 288000 0D: 384000 0E: 512000 0F: 576000 10: 768000 11: 1M 12: 2M 13: 3M 14: 4M 15: 5M 16: 6M		

Parameter	Meaning	Default setting	Setting range	Modify	Effective
P7-02	RS485 communication protocol	1	1-Modbus Rtu protocol 2-Xnet bus protocol 3-read Xnet bus torque	Servo bb	At once

2. RS232 communication parameter setting

Parameter	Meaning	Default setting	Range	Modify	Effective
P7-10	RS232 station no.	1	0~100	Servo bb	At once

Parameter	Parameter	Setting unit	Default setting	Suitable mode	Modify	Effective
P7-11	Communication configuration	-	n.2206	All	Servo bb	At once
	Parameter setting	Function	Default setting	Range		
	n.□xxx	Parity bit	0	0: no parity 1: odd 2: even		
	n.x□xx	Stop bit	0	0: 2-bit 2: 1-bit		
	n.xx□□	Baud rate	06	00: 300 01: 600 02: 1200 03: 2400 04: 4800 05: 9600 06: 19200 07: 38400 08: 57600 09: 115200 0A: 192000 0B: 256000 0C: 288000 0D: 384000 0E: 512000 0F: 576000 10: 768000 11: 1M 12: 2M 13: 3M 14: 4M 15: 5M 16: 6M		

8.3 Communication protocol

When communicating in a MODBUS network, this protocol determines that each controller needs to know their device address, identify messages sent by address, and decide what actions to take. If a response is needed, the controller generates the feedback and sends it out using Modbus protocol. In other networks, messages containing Modbus protocol are converted to frame or packet structure which can be used in this network. This conversion also extends the method of solving node address, routing path and error detection according to specific network.

8.3.1 Character structure

(1-8-2 format, no parity)

Start bit	0	1	2	3	4	5	6	7	Stop bit	Stop bit
-----------	---	---	---	---	---	---	---	---	----------	----------

(1-8-1 format, odd parity)

Start bit	0	1	2	3	4	5	6	7	Odd parity	Stop bit
-----------	---	---	---	---	---	---	---	---	------------	----------

(1-8-1 format, even parity)

Start bit	0	1	2	3	4	5	6	7	Even parity	Stop bit
-----------	---	---	---	---	---	---	---	---	-------------	----------

(1-8-1 format, no parity)

Start bit	0	1	2	3	4	5	6	7	Stop bit
-----------	---	---	---	---	---	---	---	---	----------

The default data format of servo driver is: 1-bit start bit, 8-bit data bit, 1-bit stop bit.

8.3.2 Communication data structure

1. RTU mode:

START	Keep no input signal greater than or equal to 10ms
Address	Communication address: 8-bit binary address
Function	Function code: 8-bit binary address
DATA (n - 1)	Data content: N*8-bit data, N<=8, max 8 bytes
DATA 0	
CRC CHK Low	CRC parity
CRC CHK High	16-bit CRC parity code consists of two 8-bit binary combinations
END	Keep no input and output signal greater than or equal to 10ms

2. Communication address:

Modbus address is provided in the manual, and the corresponding table of Modbus address is queried in Appendix 4.

3. Function code and data:

Function code	Explanation
03H	Read out the contents of registers, read out multiple registers, but not more than 31 at a time, and only read the data in the same group at a time
06H	Write the data to register

➤ Function code 03H: read register data

For example: read the U0-05 register address H1005 (bus voltage).

RTU mode:

Inquiry information format		Response message format	
Address	01H	Address	01H
Function code	03H	Function code	03H
register address	10H	Byte quantity	02H
	05H		
register quantity	00H	Data content	01H
	01H		34H
CRC CHECK Low	90H	CRC CHECK Low	B8H
CRC CHECK High	CBH	CRC CHECK High	03H

➤ Function code 06H: write the data in the register

For example: write 300 rpm to the address of P3-18 register of inching speed.

RTU mode:

Inquiry information format		Response message format	
Address	01H	Address	01H
Function code	06H	Function code	06H
register address	03H	register address	03H
	12H		12H
Data content	01H	Data content	01H
	2CH		2CH
CRC CHECK Low	29H	CRC CHECK Low	29H
CRC CHECK High	C6H	CRC CHECK High	C6H

4. Parity code

RTU mode: double byte hexadecimal number.

The CRC field is a two-byte, 16-bit binary value. It is calculated by the sender and added to the message; when it is added, it is first the low byte and then the high byte, so the high byte of CRC is the last byte of the sent message. The receiving device recalculates the CRC of the received message and compares it with the value in the received CRC field. If the two values are different, there is an error in the received message, discards the message frame, makes no response, and continues to receive the data of the next frame. Refer to the description of Modbus protocol for CRC verification calculation method.

8.4 Communication example

8.4.1 Communication with Xinje PLC

Xinje PLC communicates with Xinje two drivers through 485, reads the speed of motor and writes the torque limit of motor.

1. Hardware wiring: if the customer uses AB terminal of Xinje PLC for 485 communication, just connect the 14 and 15 pins of the driver to AB terminal of PLC.

2. Parameter setting: the communication parameters of the driver and PLC are set in the same way, such as baud rate, parity, data bit, slave station, etc. the communication protocols of the Xinje PLC and servo are standard Modbus RTU, namely 19200bps, 1-8-1-even parity.

The setting parameters are as follows:

P7-00 Station No. 1, 2

P7-01.0 ~ 1 baud rate 06

P7-01.2 stop bit 2

P7-01.3 check bit 2

Note: if the communication parameter settings of the upper computer and the lower computer are inconsistent, the communication will fail.

3. Software program: the register in which the station number, communication address and contents are marked when writing instructions.

(1) Station number: the value set for servo driver P7-00. K1 indicates that P7-00 is set to 1; K2 indicates that P7-00 is set to 2.

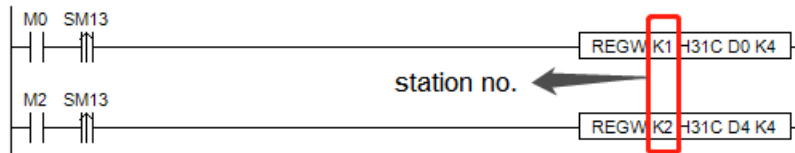

(2) Communication address: the address of the servo slave station. For the address of a register, please refer to Appendix 4. MODBUS address table.

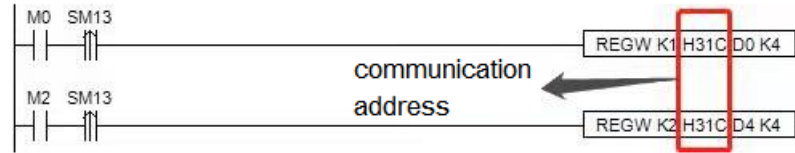

(3) register: to store the parameter value of write in address.

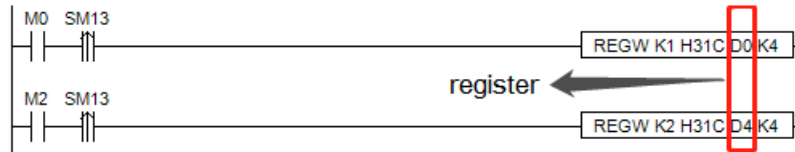

(4) serial port no.: PLC RS485 serial port number.

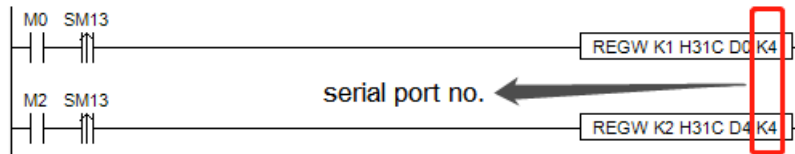

9 Appendix

Appendix 1. Group P parameters

Modification and effective:

“○” means modifying when servo OFF and take effect at once.

“√” means modifying anytime and take effect at once.

“●” means modifying when servo OFF and take effect when power on again.

“△” means modifying anytime and take effect when the motor doesn't rotate.

For parameters set in hexadecimal system, the prefix "n." is added to the setting value to indicate that the current setting value is hexadecimal number.

Composition of parameters:

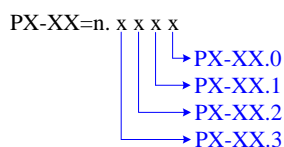

P0-XX:

Parameter	Function	Unit	Default value	Range	Effective	Suitable mode	Reference chapter
P0-01	Control mode 1 1-Internal Torque Mode 2-External Analog Torque Mode 3-Internal speed Model 4-External Analog speed Mode 5-Internal Location Mode 6-External Pulse Position Mode 7-External Pulse speed Mode 8-XNET Bus Torque Mode 9-XNET Bus Speed Mode 10-XNET Bus Location Mode	-	6	1~10	○	1 2 3 4 5 6 7 8 9 10	5.1.1
P0-02	Control mode 2 (ditto)	-	6	1~10	○	1 2 3 4 5 6 7 8 9 10	5.1.1
P0-03	Enabling mode 0-not enabled 1-IO enable 2-Software Enablation 3-XNET Bus Enablation	-	1	0~3	○	1 2 3 4 5 6 7 8 9 10	5.2.2
P0-04	Rigidity grade	-	20P1: 0 20P2/20P4/20P7: 15 >=21P5: 10	0~63	△	1 2 3 4 5 6 7 8 9 10	6.3.3

P0-05	Definition of rotation direction 0- positive mode 1- negative mode	-	0	0~1	●	1 2 3 4 5 6 7 8 9 10	5.2.3
P0-07	First inertia ratio	1%	20P1: 800 >20P1: 200	0~5000 0	√	1 2 3 4 5 6 7 8 9 10	6.2.1
P0-09.0	Forward Direction of Input Pulse Instruction 0-Forward Pulse Counting 1-Reverse Pulse Counting	-	0	0~1	●	6 7	5.3.2
P0-09.2	Input pulse command filter time	-	F	0~F	●	6 7	5.3.2

Parameter	Function	Unit	Default value	Range	Effective	Suitable mode	Reference chapter
P0-09.3	Predistribution of input pulse command filter	-	0	0~7	●	6 7	5.3.2
P0-10.0	0-CW/CCW 1-AB 2-P+D	-	2	0~2	○	6 7	5.3.2
P0-11~ P0-12	Number of instruction pulses per cycle 0: Electronic gear ratio Non-0: Number of command pulses required for motor rotation	1 pul	10000	0~99999999	○	5 6	5.3.1.1
P0-13	Electronic Gear Numerator	-	1	0~65535	○	5 6	5.3.1.1
P0-14	Denominator of Electronic Gear	-	1	0~65535	○	5 6	5.3.1.1
P0-15	Pulse frequency corresponding to rated speed	100Hz	1000	1~10000	○	7	5.4.3.2
P0-16	Speed command pulse filter time	0.01ms	100	0~10000	○	7	5.4.3.3
P0-18	Encoder feedback pulse number per turn (low bit)	0	0	0~9999	√	1 2 3 4 5 6 7 8 9 10	5.8
P0-19	Encoder feedback pulse number per turn (high bit)	10000	10000	0~9999	√	1 2 3 4 5 6 7 8 9 10	5.8
P0-23	pulse offset limit	0.01 turn	2000	0~65535	√	5 6 10	5.3.1.6
P0-24	Type selection of discharge resistance (version 3640 and before) 0: built in 1: external Power protection mode of discharge resistance (version 3700 and later) 0 - cumulative discharge time 1 - average power mode 1	-	0	0~1	○	1 2 3 4 5 6 7 8 9 10	5.2.6

	2-average power mode 2						
P0-25	Power Value of Discharge Resistance	W	Set as model	1~65535	○	1 2 3 4 5 6 7 8 9 10	5.2.6
P0-26	Discharge resistance value	Ω	Set as model	1~500	○	1 2 3 4 5 6 7 8 9 10	5.2.6
P0-27	Servo shutdown the enable stop mode 0-Inertial Operation Stop 2-deceleration stop	-	0	0~5	○	1 2 3 4 5 6 7 8 9 10	5.2.4
P0-28	Servo Overrun Stop Mode (P0-28.0) 0-deceleration stop 1 1-Inertial Stop 2-deceleration stop 2 3-Alarm Stop Overtravel alarm shield switch (P0-28.1) 0-not shield the alarm 1-shield the alarm	-	2	0~3	○	1 2 3 4 5 6 7 8 9 10	5.2.4
			0	0~1			
P0-29	Servo Alarm Stop Mode 0-Inertial Operation Stop 2-deceleration stop	-	2	0~2	○	1 2 3 4 5 6 7 8 9 10	5.2.4
P0-30	stop timeout time	1ms	20000	0~65535	○	1 2 3 4 5 6 7 8 9 10	5.2.3
P0-31	Deceleration stop time	1ms	25	0~5000	○	1 2 3 4 5 6 7 8 9 10	5.2.3
P0-33	Set the motor code	-	0	0~ffff	●	1 2 3 4 5 6 7 8 9 10	4.7

Parameter	Function	Unit	Default value	Range	Effective	Suitable mode	Reference chapter
P0-53	Read motor parameter alarm shield bit 0-not shield alarm shield alarm	-	0	0~1	●	1 2 3 4 5 6 7 8 9 10	-
P0-69	Fan switch (P0-69.0) 0- Turn on the fan when the temperature greater than 45°C and turn off the fan when less than 42°C (hysteresis 3°C) 1 - Turn on the fan after enabling, turn off the fan when not enabling Large motor thermocouple break alarm shield switch (P0-69.1) 0-shield thermocouple disconnection alarm 1-thermocouple disconnection	-	1	0~1	√	1 2 3 4 5 6 7 8 9 10	-
			0	0~1			
P0-74	Blocking alarm time	ms	0	0~5000	√	1 2 3 4 5 6	5.8.1

						7 8 9 10	
P0-75	Blocking alarm speed	rpm	50	5~9999	√	1 2 3 4 5 6 7 8 9 10	5.8.1
P0-79	Absolute Encoder Battery Undervoltage Alarm Switch (firmware version 20160304 and later) 0-used as absolute value encoder 1-1-used as incremental encoder 2-2-used as absolute value encoder, ignoring multi turn overflow alarm	-	1	0~2	●	1 2 3 4 5 6 7 8 9 10	5.7.1
P0-80	Thermal Power Protection of Motor 0-current protection 1-Average Thermal Power Protection 2-Analog Thermal Power Protection	-	2	0~2	●	1 2 3 4 5 6 7 8 9 10	-
P0-92~ P0-93	32-bit electronic gear ratio numerator. take effect when P0-11~P0-14 is 0. P0-92*1 + P0-93 *10000	-	1	1~9999 1~65535	○	5 6	5.3.1.1
P0-94~ P0-95	32-bit electronic gear ratio denominator. take effect when P0-11~P0-14 is 0. P0-94*1 + P0-95 *10000	-	1	1~9999 1~65535	○	5 6	5.3.1.1

P1-XX:

Parameter	Function	Unit	Default value	Range	Effective	Suitable mode	Reference chapter
P1-00	First speed loop gain	0.1Hz	20P1: 400 Others: 200	10~20000	√	1 2 3 4 5 6 7 8 9 10	6.5.3
P1-01	Integral Time Constant of the First Speed Loop	0.01ms	20P1: 1650 Others: 3300	15~51200	√	1 2 3 4 5 6 7 8 9 10	6.5.3
P1-02	First position loop gain	0.1/s	20P1: 400 Others: 200	10~20000	√	1 2 3 4 5 6 7 8 9 10	6.5.3
P1-10	Speed feedforward gain	1%	0	0~300	√	5 6 7 10	-
P1-11	Speed feedforward filter time	0.01ms	50	0~10000	√	5 6 7 10	-
P1-22	Speed Instruction Filter Selection 0-first order low pass filter 1-Smooth Average Filter	-	0	0~1	○	3 4 7	5.4.1.4
P1-23	speed instruction filter time	0.1ms	0	0~65535	○	3 4 7	5.4.1.4
P1-24	Position command acceleration and deceleration filtering	0.1ms	0	0~65535	△	5 6 10	5.3.1.7

Parameter	Function	Unit	Default value	Range	Effective	Suitable mode	Reference chapter
	time						
P1-25	position instruction smooth filter time	0.1ms	0	0~65535	△	5 6 10	5.3.1.7

P2-XX:

Parameter	Function	Unit	Default value	Range	Effective	Suitable mode	Reference chapter
P2-00.0	Disturbance observer switch 0- OFF 1- ON	-	0	0~1	○	1 2 3 4 5 6 7 8 9 10	6.1.4
P2-01.0	Adaptive mode switch 0-OFF 1-ON	-	3KW and below: 0 Others:1	0~1	●	1 2 3 4 5 6 7 8 9 10	6.6.3
P2-01.1	Adaptive level 0-high response 1-low noise	-	As the model	0~1	●	1 2 3 4 5 6 7 8 9 10	-
P2-02.0	Auto-tuning mode 1-soft 2-fast positioning 3-fast positioning, control the overshoot	-	3	1~3	√	1 2 3 4 5 6 7 8 9 10	6.1.3
P2-02.2	Load type (valid only during auto-tuning) 1- synchronous belt 2- screw rod 3-Rigid Connection	-	2	1~3	√	1 2 3 4 5 6 7 8 9 10	6.1.3
P2-03.3	Adaptive load type 0-Small Inertia Mode 1-Large Inertia Mode	-	0	0~1	●	1 2 3 4 5 6 7 8 9 10	6.6.4
P2-05	Adaptive mode speed loop gain (standard)	0.1Hz	20P1/20P2/ 20P4/20P7: 400 >=21P5: 200	1~65535	○	1 2 3 4 5 6 7 8 9 10	6.6.4
P2-07	Adaptive mode inertia ratio (standard)	%	0	0~10000	○	1 2 3 4 5 6 7 8 9 10	6.6.4
P2-08	Gain of adaptive mode speed observer (standard)	Hz	20P1/20P2/ 20P4/20P7: 60 >=21P5: 40	10~1000	○	1 2 3 4 5 6 7 8 9 10	6.6.4
P2-12	Maximum Inertia Ratio of Adaptive Mode (Standard)	-	30	1~10000	○	1 2 3 4 5 6 7 8 9 10	6.6.4
P2-15	Inertia Identification and Internal Instruction Auto-tuning Maximum Travel	0.01r	100	1~3000	√	1 2 3 4 5 6 7 8 9 10	6.2.4
P2-17	Maximum Speed of Inertia Identification and Internal Instruction Auto-tuning	rpm	0	0~65535	√	1 2 3 4 5 6 7 8 9 10	6.2.4

P2-16	Initial Inertia Ratio of Inertia Identification	-	100	10~1000	○	1 2 3 4 5 6 7 8 9 10	6.2.4
P2-18	Gain of adaptive mode speed observer (standard)	%	500	1~20000	√	1 2 3 4 5 6 7 8 9 10	6.2.4

Parameter	Function	Unit	Default value	Range	Effective	Suitable mode	Reference chapter
P2-19	Adaptive mode bandwidth	%	20P1: 100 20P2, 20P4: 70 >=20P7: 50	1~100	○	1 2 3 4 5 6 7 8 9 10	6.2.4
P2-35	Torque Instruction Filtering Time Constant 1	0.01ms	100	0~65535	√	1 2 3 4 5 6 7 8 9 10	6.5.3
P2-41	Disturbance Torque Compensation Coefficient (Non-adaptive Mode Effective)	%	85	0~100	√	1 2 3 4 5 6 7 8 9 10	6.1.4
P2-47.0	Model Loop Switch 0-OFF 1-ON	-	1	0~f	√	1 2 3 4 5 6 7 8 9 10	6.1.3
P2-49	Model loop gain	0.1Hz	500	10~20000	√	3 4 5 6 7 10	6.5.3
P2-60.0	Active Vibration Suppression Switch 0-OFF 1-ON	-	0	0~1	√	3 4 5 6 7 10	6.4.6
P2-60.1	Active Vibration Suppression Auto-tuning Switch 0-Active Vibration Suppression is not Configured in auto-tuning 1- configure the Active Vibration Suppression when auto-tuning	-	1	0~1	√	3 4 5 6 7 10	6.4.6
P2-61	Active Vibration Suppression frequency	0.1Hz	1000	10~20000	√	1 2 3 4 5 6 7 8 9 10	6.5
P2-62	Active Vibration Suppression gain	%	100	1~1000	√	1 2 3 4 5 6 7 8 9 10	6.4.6
P2-63	Active Vibration Suppression damping	%	100	0~300	√	1 2 3 4 5 6 7 8 9 10	6.4.6
P2-64	Filtering time of active vibration suppression 1	-	0	-5000~5000	√	1 2 3 4 5 6 7 8 9 10	6.4.6
P2-65	Filtering time of active vibration suppression 2	-	0	-5000~5000	√	1 2 3 4 5 6 7 8 9 10	6.4.6
P2-66	The second group of active vibration damping	-	0	0~1000	√	1 2 3 4 5 6 7 8 9 10	6.4.6
P2-67	Second group active vibration suppression frequency	Hz	20000	10~50000	√	1 2 3 4 5 6 7 8 9 10	6.4.6

P2-69.0	Notch filter 1 switch	-	0	0~1	√	1 2 3 4 5 6 7 8 9 10	6.4.6
P2-69.1	Notch filter 2 switch	-	0	0~1	√	1 2 3 4 5 6 7 8 9 10	6.4.6
P2-69.3	Notch filter 3 switch	-	0	0~1	√	1 2 3 4 5 6 7 8 9 10	-
P2-70.0	Notch filter 4 switch	-	0	0~1	√	1 2 3 4 5 6 7 8 9 10	-
P2-70.1	Notch filter 5 switch	-	0	0~1	√	1 2 3 4 5 6 7 8 9 10	-
P2-71	First notch frequency	Hz	5000	50~5000	√	1 2 3 4 5 6 7 8 9 10	6.7.7
P2-72	First notch attenuation	0.1dB	70	50~1000	√	1 2 3 4 5 6 7 8 9 10	6.7.7
P2-73	First notch band width	Hz	0	0~1000	√	1 2 3 4 5 6 7 8 9 10	6.7.7
P2-74	Second notch frequency	Hz	5000	50~5000	√	1 2 3 4 5 6 7 8 9 10	6.7.7
P2-75	Second notch attenuation	0.1dB	70	50~1000	√	1 2 3 4 5 6 7 8 9 10	6.7.7
P2-76	Second notch band width	Hz	0	0~1000	√	1 2 3 4 5 6 7 8 9 10	6.7.7
P2-77	Third notch frequency	Hz	5000	50~5000	√	1 2 3 4 5 6 7 8 9 10	6.7.7
P2-78	Third notch attenuation	0.1dB	70	50~1000	√	1 2 3 4 5 6 7 8 9 10	6.7.7
P2-79	Third notch band width	Hz	0	0~1000	√	1 2 3 4 5 6 7 8 9 10	6.7.7
P2-80	Fourth notch frequency	Hz	5000	50~5000	√	1 2 3 4 5 6 7 8 9 10	6.7.7
P2-81	Fourth notch attenuation	0.1dB	70	50~1000	√	1 2 3 4 5 6 7 8 9 10	6.7.7
P2-82	Fourth notch band width	Hz	0	0~1000	√	1 2 3 4 5 6 7 8 9 10	6.7.7
P2-83	Fifth notch frequency	Hz	5000	50~5000	√	1 2 3 4 5 6 7 8 9 10	6.7.7
P2-84	Fifth notch attenuation	0.1dB	70	50~1000	√	1 2 3 4 5 6 7 8 9 10	6.7.7
P2-85	Fifth notch band width	Hz	0	0~1000	√	1 2 3 4 5 6 7 8 9 10	6.7.7

P3-XX:

Parameter	Function	Unit	Default value	Range	Effective	Suitable mode	Reference chapter
P3-00	V-REF Function Allocation 0-V-REF as Speed Instruction Input 1-V-REF will be used as input reference value of external speed limit. The actual speed limit depends on the speed limit of external analog quantity.	-	0	0~2	○	1 2 4	5.5

	2-Speed Feedforward						
P3-01	Analog voltage corresponding to rated speed (5E/5L not support)	0.001V	10000	1500~30000	○	1 2 4	5.4.4
P3-02	Analog voltage speed filter (5E/5L not support)	0.01ms	200	0~10000	√	1 2 4	5.4.4
P3-03	Speed instruction input dead zone voltage (5E/5L not support)	0.001v	0	0~500	√	1 2 4	5.4.4
P3-04	V-REF analog speed direction(5E/5L not support)	-	0	0~1	√	1 2 4	5.4.4
P3-05	Preset speed 1	rpm	0	-9999~9999	√	3	5.4.2
P3-06	Preset speed 2	rpm	0	-9999~9999	√	3	5.4.2
P3-07	Preset speed 3	rpm	0	-9999~9999	√	3	5.4.2
P3-09	Acceleration time	ms	Version 3720 and before: 0 Version 3730: 200	0~65535	○	3 4 7	5.4.1.1
P3-10	Deceleration time	ms	Version 3720 and before: 0 Version 3730: 200	0~65535	○	3 4 7	5.4.1.1
P3-12	Zero-speed clamping mode	-	0	0~3	○	3 4 7	5.4.1.2
P3-13	Zero-speed clamping speed	rpm	10	0~300	○	3 4 7	5.4.1.2
P3-14	Forward Maximum Speed Instruction Limit	rpm	4000	0~10000	○	1 2 3 4 5 6 7 10	5.8.3
P3-15	Reverse Maximum Speed Instruction Limit	rpm	4000	0~10000	○	1 2 3 4 5 6 7 10	5.8.3
P3-16	Internal Forward Speed Limitation in Torque Control	rpm	2000	5~10000	√	1 2	5.5.1.2
P3-17	Internal Reverse Speed Limitation in Torque Control	rpm	2000	5~10000	√	1 2	5.5.1.2
P3-18	Jogging speed	rpm	100	0~1000	○	1 2 3 4 5 6 7 10	4.4.2
P3-19	forward warning speed	rpm	3000	0~10000	○	1 2 3 4 5 6 7 10	5.8.5.4
P3-20	reverse warning speed	rpm	3000	0~10000	○	1 2 3 4 5 6 7 10	5.8.5.4
P3-21	forward alarming speed	rpm	4000	0~10000	○	1 2 3 4 5 6 7 10	-
P3-22	reverse alarming speed	rpm	4000	0~10000	○	1 2 3 4 5 6 7 10	-
P3-23	T-REF Function Allocation	-	0	0~2	○	2 3 4 5 6 7 10	5.7.2

	0 - Input as Torque Instruction 1 - As a necessary condition for limiting input of external torque, the minimum value is valid compared with P3-28/P3-29. 2-Torque Feedforward						
--	--	--	--	--	--	--	--

Parameter	Function	Unit	Default value	Range	Effective	Suitable mode	Reference chapter
P3-24	analog value corresponding to rated torque	0.001V	10000	1500~30000	○	2 3 4 5 6 7 10	5.5.3
P3-25	Analog Voltage Torque Filtering Time	0.01ms	200	0~10000	√	2 3 4 5 6 7 10	5.5.3
P3-26	Torque instruction input dead-zone voltage	0.001V	0	0~500	√	2 3 4 5 6 7 10	5.5.3
P3-27	Analog Torque Forward Direction 0-forward 1-reverse	-	0	0~1	○	2 3 4 5 6 7 10	-
P3-28	Internal forward torque limit	%	300	0~1000	√	1 2 3 4 5 6 7 8 9 10	5.8.2
P3-29	Internal reverse torque limit	%	300	0~1000	√	1 2 3 4 5 6 7 8 9 10	5.8.2
P3-30	external forward torque limit	%	300	0~1000	√	1 2 3 4 5 6 7 8 9 10	5.8.2
P3-31	external reverse torque limit	%	300	0~1000	√	1 2 3 4 5 6 7 8 9 10	5.8.2
P3-32	Brake torque	1%	300	0~1000	√	1 2 3 4 5 6 7 8 9 10	5.2.4
P3-33	Preset torque	%	0	-1000~1000	√	1	5.5.1.1
P3-38	Anti blocking forward torque limit	%	300	0~1000	√	1 2 3 4 5 6 7 8 9 10	5.7.1
P3-39	Anti blocking reverse torque limit	%	300	0~1000	√	1 2 3 4 5 6 7 8 9 10	5.7.1
P3-45	Torque mode switching delay	ms	40	0~9999	√	1 2	-
P3-47	V-REF zero drift correction of analog quantity	-	0	-1000~1000	√	2 4	5.4.4.6
P3-48	V-REF analog voltage offset	mV	0	-9999~9999	√	2 4	5.4.4.6
P3-49	T-REF zero drift correction of analog quantity	-	0	-1000~1000	√	2 4	5.5.3.5
P3-50	T-REF analog voltage offset	mV	0	-9999~9999	√	2 4	5.5.3.5

P4-XX:

Parameter	Function	Unit	Default value	Range	Effective	Suitable mode	Reference chapter
P4-00.0	Z phase signal numbers The Z phase signal numbers after leaving the limit switch (note: stop when N+1 Z phase signal reached)	pcs	2	0~f	○	5 6 10	5.3.1.8
P4-00.1	Search the origin function 0-OFF 1-ON	-	0	0~1	○	5 6 10	5.3.1.8

Parameter	Function	Unit	Default value	Range	Effective	Suitable mode	Reference chapter
P4-00.2	return to zero overrun prohibition 0-not prohibit 1-prohibit	-	0	0~1	○	5 6 10	5.3.1.8
P4-01	Speed of hitting the proximity switch	rpm	600	0~65535	○	5 6 10	5.3.1.8
P4-02	Speed of leaving proximity switch	rpm	100	0~65535	○	5 6 10	5.3.1.8
P4-03.0	Internal Location Given Mode Sets Location Mode 0-relative positioning 1-Absolute positioning	-	0	0~1	○	5	5.3.3.1
P4-03.1	Internal Position-Given Mode Sets Step Change Mode 0-step-changing when signal is ON, recyclable 1-change step at signal rising edge, single step execution 2-starting at Signal rising edge, sequential execution of all, no cycle 3-set segment no. through communication 4-/CHSTP dual edge triggerring 5-terminal/PREFA(P5-57), /PREFB(P5-58), /PREFC(P5-59) select the segment no., range 1~3 6-terminal/PREFA (P5-57), /PREFB(P5-58), /PREFC(P5-59) select segment no., range 1~8	-	0	0~6	○	6	5.3.3.1
P4-03.2	Internal position mode sets waiting mode 0-wait positioning completion 1-not wait positioning completion	-	0	0~1	○	5	5.3.3.1
P4-04	Valid segment number	-	0	0~35	○	5	5.3.3.2
P4-08	Internal position mode start segment No	-	1	0~35	○	5	5.3.3.3
P4-10~ P4-11	First segment pulse	1pul	0	-32768999 9~327679 999	√	5	5.4.3
P4-12	First segment speed	0.1rpm	0	0~65535	√	5	5.4.3
P4-13	First segment acceleration time	1ms	0	0~65535	√	5	5.4.3
P4-14	First segment deceleration time	1ms	0	0~65535	√	5	5.4.3
P4-16	Adjusting time	1ms	0	0~65535	√	5	5.4.3
P4-10+ (n-1) *7 ~ P4-16+ (n-1) *7	segment 1 to 35 pulse parameters (n is segment number)	-	-	-	√	5	5.4.3

P5-XX:

Parameter	Function	Unit	Default value	Range	Effective	Suitable mode	Reference chapter
P5-00	Positioning completion width/COIN	Command unit	11	1~65535	√	5 6 10	5.3.1.2

Parameter	Function	Unit	Default value	Range	Effective	Suitable mode	Reference chapter
P5-01	Location Completion Detection Mode	-	0	0~3	√	5 6 10	5.3.1.2
P5-02	Location completion retention time	ms	0	0~65535	√	5 6 10	5.3.1.2
P5-03	Rotation Detection Speed	rpm	50	0~10000	√	1 2 3 4 5 6 7 8 9 10	5.8.5.2
P5-04	Same speed detection speed	rpm	50	0~10000	√	1 2 3 4 5 6 7 8 9 10	5.8.5.3
P5-05	Reached detection speed	Rpm	1000	0~10000	√	1 2 3 4 5 6 7 8 9 10	5.4.1.3
P5-06	Positioning near output width	Command unit	50	1~65535	√	5 6 10	5.3.1.3
P5-07	Servo OFF delay time	Ms	500	-500~9999	○	1 2 3 4 5 6 7 8 9 10	5.2.5
P5-08	Brake instruction output speed	Rpm	30	20~10000	○	1 2 3 4 5 6 7 8 9 10	5.2.5
P5-09	Brake instruction waiting time	Ms	500	0~65535	○	1 2 3 4 5 6 7 8 9 10	5.2.5
P5-10	user-defined output 1 trigger condition	-	0	0~ffff	√	1 2 3 4 5 6 7 8 9 10	5.8.5.7
P5-11	Set a value that compares with the trigger condition of custom output 1	Relating to trigger condition	0	-9999~9999	√	1 2 3 4 5 6 7 8 9 10	5.8.5.7
P5-12	Select custom output 1 mode	-	0	0~3	√	1 2 3 4 5 6 7 8 9 10	5.8.5.7
P5-13	Setting custom output 1 hysteresis	Relating to trigger condition	0	0~65535	√	1 2 3 4 5 6 7 8 9 10	5.8.5.7
P5-14	Custom Output 2 Trigger Condition	-	0	0~ffff	√	1 2 3 4 5 6 7 8 9 10	5.8.5.7
P5-15	Set a value that compares with the trigger condition of custom output 2	Relating to trigger condition	0	-9999~9999	√	1 2 3 4 5 6 7 8 9 10	5.8.5.7
P5-16	Select custom output 2 mode	-	0	0~3	√	1 2 3 4 5 6 7 8 9 10	5.8.5.7
P5-17	Setting custom output 2 hysteresis	Relating to trigger condition	0	0~65535	√	1 2 3 4 5 6 7 8 9 10	5.8.5.7
P5-18	SI filter time multiple	-	1	0~10000	√	1 2 3 4 5 6 7 8 9 10	5.8.4.1
P5-19	Z phase output maintain time	ms	2	1~65535	√	1 2 3 4 5 6 7 8 9 10	5.8.5.6
P5-20.0~1	/S-ON: servo signal 00: Set the signal to be invalid all the time. 01: Input positive signal from SI1 terminal.	-	01	0~ff	√	1 2 3 4 5 6 7 8 9 10	5.2.2

Parameter	Function	Unit	Default value	Range	Effective	Suitable mode	Reference chapter
	02: Input positive signal from SI2 terminal. 03: Input positive signal from SI3 terminal. 04: Input positive signal from SI4 terminal. 10: Set the signal to always be "valid". 11: Inverse signal is input from SI1 terminal. 12: Inverse signal is input from SI2 terminal. 13: Inverse signal is input from SI3 terminal. 14: Inverse signal is input from SI4 terminal.						
P5-20.2	SI terminal filtering time	ms	0	0~f	√	1 2 3 4 5 6 7 8 9 10	5.8.4.1
P5-21.0~1	/P-CON proportion action instruction	-	00	0~ff	√	1 2 3 4 5 6 7 8 9 10	5.8.6.1
P5-21.2	SI terminal filtering time	ms	0	0~f	√	1 2 3 4 5 6 7 8 9 10	5.8.4.1
P5-22.0~1	/P-OT: Forbidden forward driving	-	03	0~ff	√	1 2 3 4 5 6 7 8 9 10	5.2.4
P5-22.2	SI terminal filtering time	ms	0	0~f	√	1 2 3 4 5 6 7 8 9 10	5.8.4.1
P5-23.0~1	/N-OT: forbidden reverse driving	-	04	0~ff	√	1 2 3 4 5 6 7 8 9 10	5.2.4
P5-23.2	SI terminal filtering time	ms	0	0~f	√	1 2 3 4 5 6 7 8 9 10	5.8.4.1
P5-24.0~1	/ALM-RST: alarm clear	-	02	0~ff	√	1 2 3 4 5 6 7 8 9 10	5.8.6.2
P5-24.2	SI terminal filtering time	ms	0	0~f	√	1 2 3 4 5 6 7 8 9 10	5.8.4.1
P5-25.0~1	/P-CL: External Torque Limitation at Forward Rotation Side	-	00	0~ff	√	1 2 3 4 5 6 7 8 9 10	5.8.2
P5-25.2	SI terminal filtering time	ms	0	0~f	√	1 2 3 4 5 6 7 8 9 10	5.8.4.1
P5-26.0~1	/N-CL: External Torque Limitation at Reverse Rotation Side	-	00	0~ff	√	1 2 3 4 5 6 7 8 9 10	5.8.2
P5-26.2	SI terminal filtering time	ms	0	0~f	√	1 2 3 4 5 6 7 8 9 10	5.8.4.1
P5-27.0~1	/SPD-D: Internal Speed Direction Selection	-	00	0~ff	√	1 2 3 4 7	5.4.2
P5-27.2	SI terminal filtering time	ms	0	0~f	√	1 2 3 4 7	5.8.4.1
P5-28.0~1	/SPD-A: Internal Setting Speed Selection	-	00	0~ff	√	3 5	5.4.2
P5-28.2	SI terminal filtering time	ms	0	0~f	√	3 5	5.8.4.1
P5-29.0~1	/SPD-B: Internal Setting Speed Selection	-	00	0~ff	√	3 5	5.4.2
P5-29.2	SI terminal filtering time	ms	0	0~f	√	3 5	5.8.4.1
P5-30.0~1	/C-SEL: control mode selection	-	00	0~ff	√	1 2 3 4 5 6 7 8 9 10	5.1.2

Parameter	Function	Unit	Default value	Range	Effective	Suitable mode	Reference chapter
P5-30.2	SI terminal filtering time	ms	0	0~f	√	1 2 3 4 5 6 7 8 9 10	5.8.4.1
P5-31.0~1	/ZCLAMP: zero position clamping	-	00	0~ff	√	3 4 7	5.4.1.2
P5-31.2	SI terminal filtering time	ms	0	0~f	√	3 4 7	5.8.4.1
P5-32.0~1	/INHIBIT: Instruction pulse prohibition	-	00	0~ff	√	5 6 7	5.3.1.4
P5-32.2	SI terminal filtering time	ms	0	0~f	√	5 6 7	5.8.4.1
P5-34.0~1	/CLR: pulse offset clear	-	00	0~ff	√	5 6 10	5.3.1.5
P5-34.2	SI terminal filtering time	ms	0	0~f	√	5 6 10	5.8.4.1
P5-35.0~1	/CHGSTP: internal position mode change step signal	-	00	0~ff	√	5	5.3.3
P5-35.2	SI terminal filtering time	ms	0	0~f	√	5	5.8.4.1
P5-36.0~1	/I-SEL: inertia ratio switching	-	00	0~ff	√	1 2 3 4 5 6 7 8 9 10	6.6.7
P5-36.2	SI terminal filtering time	ms	0	0~f	√	1 2 3 4 5 6 7 8 9 10	5.8.4.1
P5-37	/COIN_HD: Location Completion Maintenance 00: No output to terminal 01: Output positive signal from SO1 terminal 02: Output positive signal from SO2 terminal 03: Output positive signal from SO3 terminal 11: Output reverse signal from SO1 terminal 12: Output reverse signal from SO2 terminal. 13: Output reverse Signal from SO3 terminal	-	0000	0~ffff	√	5 6 10	5.3.1.2
P5-38	/COIN: positioning completion	-	0001	0~ffff	√	5 6 10	5.3.1.2
P5-39	/V-CMP: same speed detection	-	0000	0~ffff	√	3 4 7	5.8.5.3
P5-40	/TGON: rotation detection	-	0000	0~ffff	√	1 2 3 4 5 6 7 8 9 10	5.8.5.2
P5-41	/S-RDY: ready	-	0000	0~ffff	√	1 2 3 4 5 6 7 8 9 10	5.8.5.1
P5-42	/CLT: torque limit	-	0000	0~ffff	√	1 2 3 4 5 6 7 8 9 10	5.8.2
P5-43	/VLT: speed limit detection	-	0000	0~ffff	√	1 2	5.5.1.3
P5-44	/BK: brake locking	-	0000	0~ffff	○	1 2 3 4 5 6 7 8 9 10	5.2.5
P5-45	/WARN: warning	-	0000	0~ffff	√	1 2 3 4 5 6 7 8 9 10	5.12.2
P5-46	/NEAR: near	-	0000	0~ffff	√	5 6 10	5.3.7
P5-47	/ALM: alarm	-	0002	0~ffff	√	1 2 3 4 5 6 7 8 9 10	5.2.6
P5-48	/Z: encoder Z phase signal output	-	0000	0~ffff	√	1 2 3 4 5 6 7 8 9 10	5.12.5
P5-49	/XNETERR: Xnet error	-	0	0~ffff	√	10	-

Parameter	Function	Unit	Default value	Range	Effective	Suitable mode	Reference chapter
	signal						
P5-50	/MRUN: internal position mode motion starting signal	-	0000	0~ffff	√	5	5.3.3.6
P5-51	/V-RDY: speed reached	-	0000	0~ffff	√	3 4 7	5.4.1.3
P5-52	/USER1: user-defined output 1	-	0000	0~ffff	√	1 2 3 4 5 6 7 8 9 10	5.8.5.7
P5-53	/USER2: user-defined output 2	-	0000	0~ffff	√	1 2 3 4 5 6 7 8 9 10	5.8.5.7
P5-57.0~1	/PREFA: internal position selection signal A	-	00	0~ff	√	5	5.3.3.1
P5-57.2	SI terminal filtering time	ms	0	0~f	√	5	5.8.4.1
P5-58.0~1	/PREFB: internal position selection signal B	-	00	0~ff	√	5	5.3.3.1
P5-58.2	SI terminal filtering time	ms	0	0~f	√	5	5.8.4.1
P5-59.0~1	/PREFC: internal position selection signal C	-	00	0~ff	√	5	5.3.3.1
P5-59.2	SI terminal filtering time	ms	0	f~f	√	5	5.8.4.1
P5-61.0~1	/TRAJ-START: Motion start trigger signal	-	00	0~ff	√	5	
P5-61.2	SI terminal filtering time	ms	0	0~f	√	5	
P5-70	/SRDY: Output Conditions Selection 0: This terminal is turned on after initialization of the driver is completed 1: This terminal will not turn on until enabled.	-	0	0~1	√	1 2 3 4 5 6 7 8 9 10	5.8.5.1
P5-71	Function Selection of Directional Terminal of Pulse Speed Mode	-	0	0~1	○	7	5.4.3.4

P6-XX:

Parameter	Function	Unit	Default value	Range	Effective	Suitable mode	Reference chapter
P6-05	Adaptive Mode Speed Loop Gain (Large Inertia)	0.1Hz	200	1~65535	○	1 2 3 4 5 6 7 8 9 10	6.2.4
P6-07	Adaptive mode inertia ratio (Large inertia)	%	50	0~10000	○	1 2 3 4 5 6 7 8 9 10	6.2.4
P6-08	Gain of adaptive mode speed observer (large inertia)	Hz	40	10~1000	○	1 2 3 4 5 6 7 8 9 10	6.2.4
P6-12	Maximum Inertia Ratio of Adaptive Mode (Large Inertia)	-	50	1~10000	○	1 2 3 4 5 6 7 8 9 10	6.2.4

P7-XX:

Parameter	Function	Unit	Default value	Range	Effective	Suitable mode	Reference chapter
P7-00	RS485 station no.	-	1	0~100	○	1 2 3 4 5 6 7 8 9 10	8.2
P7-01.0~1	RS485 baud rate 00: 300 01: 600 02: 1200 03: 2400 04: 4800 05: 9600 06: 19200 07: 38400 08: 57600 09: 115200 0A: 192000 0B: 256000 0C: 288000 0D: 384000 0E: 512000 0F: 576000 10: 768000 11: 1M 12: 2M 13: 3M 14: 4M 15: 5M 16: 6M	baud rate	06	0~16	○	1 2 3 4 5 6 7 8 9 10	8.2
P7-01.2	RS485 stop bit 0: 2 bits 2: 1 bit	Stop bit	2	0~2	○	1 2 3 4 5 6 7 8 9 10	8.2
P7-01.3	RS485 parity bit 0-no parity 1-odd parity 2-even parity	Parity bit	2	0~2	○	1 2 3 4 5 6 7 8 9 10	8.2
P7-02	RS485 communication protocol 1-Modbus Rtu protocol 2-Xnet bus protocol 3-read Xnet bus torque	-	1	1~255	○	1 2 3 4 5 6 7 8 9 10	8.2
P7-03	Xnet Synchronized sampling time	1ms	9	1~500	○	10	5.6.2.1
P7-04	Xnet slave station data	-	15	1~500	○	10	5.6.2.1
P7-05	Xnet slave station numbers	-	10	1~20	○	10	5.6.2.1
P7-06	Number of communication overtime retries	times	10	1~500	○	10	5.6.2.1

Parameter	Function	Unit	Default value	Range	Effective	Suitable mode	Reference chapter
P7-07	Bus instruction refresh cycle	1us	3000	1~65535	○	10	5.6.2.1
P7-08	Compensation Threshold of Position Deviation	-	0	0~0	√	10	5.6.2.1
P7-09	Compensation times for Position Deviation	-	0	0~0	√	10	5.6.2.1
P7-10	RS232 station no.	-	1	0~100	√	1 2 3 4 5 6 7 8 9 10	8.2
P7-11.0~1	RS232 baud rate 00: 300 01: 600 02: 1200 03: 2400 04: 4800 05: 9600 06: 19200 07: 38400 08: 57600 09: 115200 0A: 192000 0B: 256000 0C: 288000 0D: 384000 0E: 512000 0F: 576000 10: 768000 11: 1M 12: 2M 13: 3M 14: 4M 15: 5M 16: 6M	baud rate	06	0~16	√	1 2 3 4 5 6 7 8 9 10	8.2
P7-11.2	RS232 stop bit 0: 2-bit 2: 1 bit	Stop bit	2	0~2	√	1 2 3 4 5 6 7 8 9 10	8.2
P7-11.3	RS232 parity bit 0-no parity 1-odd parity 2-even parity	Parity bit	2	0~2	√	1 2 3 4 5 6 7 8 9 10	8.2
P7-20	Return to zero direction (bus)	-	1	-9999~9999 9	√	10	5.6.2.1
P7-21	Filtering time after return to zero(bus)	ScanA Cycle	400	1~65535	√	10	5.6.2.1

P9-XX:

Parameter	Function	Unit	Default value	Range	Effective	Suitable mode	Reference chapter
P9-00.0	Full closed loop control mode switch	-	0	0~1	√	1 2 3 4 5 6 7 8 9 10	5.9.3.1
P9-00.1	Counting direction of grating ruler	-	0	0~1	√	1 2 3 4 5 6 7 8 9 10	5.9.3.2
P9-00.2	Grating scale ruler	-	0	0~2	√	1 2 3 4 5 6 7 8 9 10	5.9.3.2
P9-01.0	Full closed loop control speed and feedback selection	-	0	0~1	√	1 2 3 4 5 6 7 8 9 10	5.9.3.3
P9-01.1	Z phase signal source	-	0	0~1	√	1 2 3 4 5 6 7 8 9 10	5.9.3.3
P9-01.2	servo pulse output	-	0	0~1	√	1 2 3 4 5 6 7 8 9 10	5.9.3.3
P9-02	Alarm value of excessive deviation between motor and load position	-	100	0~65535	√	1 2 3 4 5 6 7 8 9 10	5.9.3.5
P9-03	Motor load position deviation clearing setting	-	0	0~65535	√	1 2 3 4 5 6 7 8 9 10	5.9.3.5
P9-04	Motor load speed deviation too large alarm	-	100	0~65535	√	1 2 3 4 5 6 7 8 9 10	5.9.3.5
P9-05	Number of feedback pulses per turn of motor encoder	pulse	0	0~9999	√	1 2 3 4 5 6 7 8 9 10	5.9.3.4
P9-06	Number of feedback pulses per turn of motor encoder	pulse	0	0~9999	√	1 2 3 4 5 6 7 8 9 10	5.9.3.4
P9-07	Number of feedback pulses per turn of grating ruler	pulse	0	0~9999	√	1 2 3 4 5 6 7 8 9 10	5.9.3.4
P9-08	Number of feedback pulses per turn of grating ruler	pulse	0	0~9999	√	1 2 3 4 5 6 7 8 9 10	5.9.3.4

Appendix 2. UX-XX monitoring parameters

U0-XX:

Code	Contents	Unit
U0-00	servo motor speed	Rpm
U0-01	Input speed instruction	Rpm
U0-02	Torque instruction	% rated
U0-03	Mechanical angle	1 °
U0-04	Electric angle	1 °
U0-05	Bus voltage	V
U0-06	IPM temperature	°C
U0-07	Torque feedback	% rated
U0-08	pulse offset	(0000~9999) *1
U0-09		(0000~65535) *10000
U0-10	Encoder feedback	(0000~9999) *1
U0-11		(0000~65535) *10000
U0-12	input instruction pulse numbers	(0000~9999) *1
U0-13		(0000~65535) *10000
U0-14	position feedback	(0000~9999) *1
U0-15		(0000~65535) *10000
U0-16	encoder accumulated position	(0000~9999) *1
U0-17		(0000~65535) *10000

U0-18	Torque current		0.01A
U0-19	Analog input V-REF value		0.01V
U0-20	Analog input T-REF value		0.01V
U0-21	Input signal status 1		
U0-22	Input signal status 2		
U0-23	output signal status 1		
U0-24	output signal status 2		
U0-25	Input pulse frequency	(0000~9999) *1	1Hz
U0-26		(0000~9999) *10000	
U0-37	VREF AD Raw value		
U0-38	TREF AD Raw value		
U0-41	Instantaneous output power		1W
U0-42	Average output power		1W
U0-43	Instantaneous thermal power		1W
U0-44	average thermal power		1W
U0-49	position feedforward		1 command unit
U0-50	speed feedforward		rpm
U0-51	torque feedforward		% rated
U0-52	Instantaneous Bus Capacitor Power		1W
U0-53	Average Bus Capacitor Power		1W
U0-55	Discharge power of instantaneous regenerative braking		1W
U0-56	Average regenerative brake discharge power		1W
U0-57	Absolute encoder present position	(0000~65536) *1	Encoder pulse
U0-58	feedback low 32-bit	(0000~65536) *2 ¹⁶	
Code	Contents		Unit
U0-59	Absolute encoder present position	(0000~65536) *2 ³²	Encoder pulse
U0-60	feedback high 32-bit	(0000~65536)	
U0-61	Xnet communication error amounts		
U0-62	Xnet Communication Waiting Synchronization Frame State Interference		
U0-63	Xnet Communication Waiting for Synchronization Frame State Receiving Data Frame		
U0-64	Xnet Communication Waiting Data Frame State Interference		
U0-65	Xnet Communication Waiting for Data Frame Status Receive Synchronized Frame		
U0-66	Xnet communication CRC parity error		
U0-67	Xnet communication UART error		
U0-68	Xnet communication timeout counting		
U0-69	Communication encoder timeout counting		
U0-88	Motor code reading status		
U0-89	Real-time speed feedback (displaying range -99.99~99.99rpm)		0.01rpm
U0-91	Multi-turn absolute motor circles		
U0-94	Encoder feedback position after calibration	(0000~65536) *1	Encoder pulses
U0-95		(0000~65536) *2 ¹⁶	
U0-96		(0000~65536) *2 ³²	
U0-97		(0000~65536)	
U0-98	High power motor temperature		°C

U1-XX:

Code	Contents	Unit
U1-00	present alarm code	
U1-01	present warning code	
U1-02	U phase current when alarming	0.01A
U1-03	V phase current when alarming	0.01A
U1-04	bus voltage when alarming	V
U1-05	IGBT temperature when alarming	°C
U1-06	torque current when alarming	0.01A
U1-07	excitation current when alarming	A
U1-08	position offset when alarming	Instruction pulse
U1-09	speed when alarming	rpm
U1-10	Seconds(low 16-bit) when alarming, cumulated seconds from the first time power-on	s
U1-11	Seconds(high 16-bit) when alarming, cumulated seconds from the first time power-on	s
U1-12	this time running error numbers, counting after power on this time	
U1-13	this time operation warning numbers, counting after power on this time	
U1-14	historical alarm amounts	
U1-15	historical warning amounts	
U1-16	Recent 2nd alarm code	
U1-17	Recent 3rd alarm code	
U1-18	Recent 4th alarm code	
U1-19	Recent 5th alarm code	
U1-20	Recent 6th alarm code	
U1-21	Recent 2nd warning code	
U1-22	Recent 3rd warning code	
U1-23	Recent 4th warning code	
U1-24	Recent 5th warning code	
U1-25	Recent 6th warning code	

U2-XX:

Code	Contents	Unit
U2-00	Power on times	
U2-01	series	
U2-02	Model (low 16-bit)	
U2-03	Model (high 16-bit)	
U2-04	out of factory date: year	
U2-05	out of factory date: month	
U2-06	out of factory date: day	
U2-07	Firmware version	
U2-08	Hardware version	
U2-09	Total running time (from the first time power on)	hour
U2-10	Total running time (from the first time power on)	minute
U2-11	Total running time (from the first time power on)	second
U2-12	This time running time (from this time power on)	hour
U2-13	This time running time (from this time power on)	minute
U2-14	This time running time (from this time power on)	second
U2-15	Average output power (from the first time enabled, average power in the process of enabling)	1W

U2-16	Average thermal power (from the first time enabled, average power in the process of enabling)	1W
U2-17	Average bus capacitor filter power (from the first time power on, average power in the process of power on)	1W
U2-20	Device serial no.: low 16-bit	
U2-21	Device serial no.: high 16-bit	
U2-22	Firmware generation date: year	
U2-23	Firmware generation date:month/day	
U2-24	Firmware generation date: hour/minute	

U3-XX:

Code	Contents	Unit
U3-00	Motor code (including thermal power parameters) read automatically by driver	-
U3-01	Motor version	-
U3-02	Encoder version	-
U3-70	Automatically read the motor code of the encoder in the motor parameters (only related to the motor code)	-

U4-XX:

Code	Contents	Unit
U4-10	Resonance frequency detected by fast FFT	Hz
U4-11	Original data of grating ruler	Encoder pulse
U4-12	Original data of grating ruler	Encoder pulse
U4-13	Original Z phase numbers of grating ruler	
U4-14	Feedback of motor encoder under full closed loop *1	Encoder pulse
U4-15	Feedback of motor encoder under full closed loop *10000	Encoder pulse

Appendix 3. FX-XX auxiliary function parameters

Code	Contents	Effective	Reference chapter
F0-00	Clear the alarm	Servo OFF	4.4.1
F0-01	Restore to out of factory settings	Servo OFF	4.4.1
F0-02	clear the position offset	Servo OFF	4.4.1
F0-07	Panel inertia identification	Servo OFF	6.3.4
F0-08	Panel external command auto-tuning	Servo OFF	6.5.5
F0-09	Panel internal command auto-tuning	Servo OFF	6.5.4
F0-10	Panel vibration suppression 1	Servo OFF	6.7.4
F0-11	Panel vibration suppression 2	Servo OFF	6.7.4
F0-12	Panel vibration suppression (Quick FFT)	Servo OFF	6.7.6
F1-00	Jog run	Servo OFF	4.4.2
F1-01	Test run	Servo OFF	4.4.2
F1-02	Current Sampling Zero-correction	Servo OFF	4.4.2
F1-03	Vref (speed analog) zero-correction	Servo OFF	4.4.2
F1-04	Tref (torque analog) zero-correction	Servo OFF	4.4.2
F1-05	software enable	Servo OFF	4.4.2
F1-06	Absolute encoder position clear	Servo OFF	5.11.5

Appendix 4. Modbus address list

Parameter	Modbus address	Notes
P0-00~P0-xx	0x0000~0x0063	Modbus address is added 1 in turn from 0x0000, for example, Modbus address of P0-23 is 0x0017
P1-00~P1-xx	0x0100~0x0163	Modbus address is added 1 in turn from 0x0100, for example, Modbus address of P1-10 is 0x010A
P2-15~P2-xx	0x020F~0x0263	Modbus address is added 1 in turn from 0x020F, for example, Modbus address of P2-16 is 0x0210
P3-00~P3-xx	0x0300~0x0363	Modbus address is added 1 in turn from 0x0300, for example, Modbus address of P3-13 is 0x030D
P4-00~P4-xx	0x0400~0x0463	Modbus address is added 1 in turn from 0x0400, for example, Modbus address of P4-25 is 0x0419
P5-00~P5-xx	0x0500~0x0563	Modbus address is added 1 in turn from 0x0500, for example, Modbus address of P5-20 is 0x0514
P6-00~P6-xx	0x0600~0x0663	Modbus address is added 1 in turn from 0x0600, for example, Modbus address of P6-05 is 0x0605
P7-00~P7-xx	0x0700~0x0763	Modbus address is added 1 in turn from 0x0700, for example, Modbus address of P7-11 is 0x070B
U0-00~U0-xx	0x1000~0x1063	Modbus address is added 1 in turn from 0x1000, for example, Modbus address of U0-05 is 0x1005
U1-00~U1-xx	0x1100~0x1163	Modbus address is added 1 in turn from 0x1100, for example, Modbus address of U1-14 is 0x110E
U2-00~U2-xx	0x1200~0x1263	Modbus address is added 1 in turn from 0x1200, for example, Modbus address of U2-08 is 0x1208

Parameter	Modbus address	Notes
U4-00~U4-xx	0x1400~0x1463	Modbus address is added 1 in turn from 0x1400, for example, Modbus address of U4-11 is 0x120B
F0-00~F0-xx	0x2000~0x2063	Modbus address is added 1 in turn from 0x2000, for example, Modbus address of F0-01 is 0x2001
F1-00~F1-xx	0x2100~0x2163	Modbus address is added 1 in turn from 0x2100, for example, Modbus address of F1-03 is 0x2103

Note: if the following parameters are not involved in the Modbus address table, follow the address rules in the table above.

■ Group P parameter address

Parameter	Modbus address		Parameter	Modbus address	
	Hex	Decimal		Hex	Decimal
P0-00	0x0000	0	P0-17	0x0011	17
P0-01	0x0001	1	P0-18	0x0012	18
P0-02	0x0002	2	P0-19	0x0013	19
P0-03	0x0003	3	P0-20	0x0014	20
P0-04	0x0004	4	P0-21	0x0015	21
P0-05	0x0005	5	P0-22	0x0016	22
P0-06	0x0006	6	P0-23	0x0017	23
P0-07	0x0007	7	P0-24	0x0018	24
P0-08	0x0008	8	P0-25	0x0019	25

P0-09	0x0009	9	P0-26	0x001A	26
P0-10	0x000A	10	P0-27	0x001B	27
P0-11	0x000B	11	P0-28	0x001C	28
P0-12	0x000C	12	P0-29	0x001D	29
P0-13	0x000D	13	P0-30	0x001E	30
P0-14	0x000E	14	P0-31	0x001F	31
P0-15	0x000F	15	P0-32	0x0020	32
P0-16	0x0010	16	P0-33	0x0021	33

Parameter	Modbus address		Parameter	Modbus address	
	Hex	Decimal		Hex	Decimal
P1-00	0x0100	256	P1-15	0x010F	271
P1-01	0x0101	257	P1-16	0x0110	272
P1-02	0x0102	258	P1-17	0x0111	273
P1-03	0x0103	259	P1-18	0x0112	274
P1-04	0x0104	260	P1-19	0x0113	275
P1-05	0x0105	261	P1-20	0x0114	276
P1-06	0x0106	262	P1-21	0x0115	277
P1-07	0x0107	263	P1-22	0x0116	278
P1-08	0x0108	264	P1-23	0x0117	279
P1-09	0x0109	265	P1-24	0x0118	280
P1-10	0x010A	266	P1-25	0x0119	281
P1-11	0x010B	267	P1-26	0x011A	282
P1-12	0x010C	268	P1-27	0x011B	283
P1-13	0x010D	269	P1-28	0x011C	284
P1-14	0x010E	270			

Parameter	Modbus address		Parameter	Modbus address	
	Hex	Decimal		Hex	Decimal
P2-00	0x0200	512	P2-15	0x020F	527
P2-01	0x0201	513	P2-16	0x0210	528

Parameter	Modbus address		Parameter	Modbus address	
	Hex	Decimal		Hex	Decimal
P3-00	0x0300	768	P3-19	0x0313	787
P3-01	0x0301	769	P3-20	0x0314	788
P3-02	0x0302	770	P3-21	0x0315	789
P3-03	0x0303	771	P3-22	0x0316	790
P3-04	0x0304	772	P3-23	0x0317	791
P3-05	0x0305	773	P3-24	0x0318	792
P3-06	0x0306	774	P3-25	0x0319	793
P3-07	0x0307	775	P3-26	0x031A	794
P3-08	0x0308	776	P3-27	0x031B	795
P3-09	0x0309	777	P3-28	0x031C	796
P3-10	0x030A	778	P3-29	0x031D	797
P3-11	0x030B	779	P3-30	0x031E	798
P3-12	0x030C	780	P3-31	0x031F	799
P3-13	0x030D	781	P3-32	0x0320	800
P3-14	0x030E	782	P3-33	0x0321	801
P3-15	0x030F	783	P3-34	0x0322	802

P3-16	0x0310	784	P3-35	0x0323	803
P3-17	0x0311	785	P3-36	0x0324	804
P3-18	0x0312	786			

Parameter	Modbus address		Parameter	Modbus address	
	Hex	Decimal		Hex	Decimal
P4-00	0x0400	1024	P4-15	0x040F	1039
P4-01	0x0401	1025	P4-16	0x0410	1040

Parameter	Modbus address		Parameter	Modbus address	
	Hex	Decimal		Hex	Decimal
P5-00	0x0500	1280	P5-27	0x051B	1307
P5-01	0x0501	1281	P5-28	0x051C	1308
P5-02	0x0502	1282	P5-29	0x051D	1309
P5-03	0x0503	1283	P5-30	0x051E	1310
P5-04	0x0504	1284	P5-31	0x051F	1311
P5-05	0x0505	1285	P5-32	0x0520	1312
P5-06	0x0506	1286	P5-33	0x0521	1313
P5-07	0x0507	1287	P5-34	0x0522	1314
P5-08	0x0508	1288	P5-35	0x0523	1315
P5-09	0x0509	1289	P5-36	0x0524	1316
P5-10	0x050A	1290	P5-37	0x0525	1317
P5-11	0x050B	1291	P5-38	0x0526	1318
P5-12	0x050C	1292	P5-39	0x0527	1319
P5-13	0x050D	1293	P5-40	0x0528	1320
P5-14	0x050E	1294	P5-41	0x0529	1321
P5-15	0x050F	1295	P5-42	0x052A	1322

Parameter	Modbus address		Parameter	Modbus address	
	Hex	Decimal		Hex	Decimal
P5-16	0x0510	1296	P5-43	0x052B	1323
P5-17	0x0511	1297	P5-44	0x052C	1324
P5-18	0x0512	1298	P5-45	0x052D	1325
P5-19	0x0513	1299	P5-46	0x052E	1326
P5-20	0x0514	1300	P5-47	0x052F	1327
P5-21	0x0515	1301	P5-48	0x0530	1328
P5-22	0x0516	1302	P5-49	0x0531	1329
P5-23	0x0517	1303	P5-50	0x0532	1330
P5-24	0x0518	1304	P5-51	0x0533	1331
P5-25	0x0519	1305	P5-52	0x0534	1332
P5-26	0x051A	1306	P5-53	0x0535	1333

Parameter	Modbus address		Parameter	Modbus address	
	Hex	Decimal		Hex	Decimal
P6-00	0x0600	1536	P6-10	0x060A	1546
P6-01	0x0601	1537	P6-11	0x060B	1547

Parameter	Modbus address		Parameter	Modbus address	
	Hex	Decimal		Hex	Decimal
P7-00	0x0700	1792	P7-10	0x070A	1802
P7-01	0x0701	1793			

■ Monitoring status address of group U

Parameter	Modbus address		Parameter	Modbus address	
	Hex	Decimal		Hex	Decimal
U0-00	0x1000	4096	U0-28	0x101C	4124
U0-01	0x1001	4097	U0-29	0x101D	4125
U0-02	0x1002	4098	U0-30	0x101E	4126
U0-03	0x1003	4099	U0-31	0x101F	4127
U0-04	0x1004	4100	U0-32	0x1020	4128
U0-05	0x1005	4101	U0-33	0x1021	4129
U0-06	0x1006	4102	U0-34	0x1022	4130
U0-07	0x1007	4103	U0-35	0x1023	4131
U0-08	0x1008	4104	U0-36	0x1024	4132
U0-09	0x1009	4105	U0-37	0x1025	4133
U0-10	0x100A	4106	U0-38	0x1026	4134
U0-11	0x100B	4107	U0-39	0x1027	4135
U0-12	0x100C	4108	U0-40	0x1028	4136
U0-13	0x100D	4109	U0-41	0x1029	4137
U0-14	0x100E	4110	U0-42	0x102A	4138
U0-15	0x100F	4111	U0-43	0x102B	4139
U0-16	0x1010	4112	U0-44	0x102C	4140
U0-17	0x1011	4113	U0-45	0x102D	4141
U0-18	0x1012	4114	U0-46	0x102E	4142
U0-19	0x1013	4115	U0-47	0x102F	4143
U0-20	0x1014	4116	U0-48	0x1030	4144

Parameter	Modbus address		Parameter	Modbus address	
	Hex	Decimal		Hex	Decimal
U0-21	0x1015	4117	U0-49	0x1031	4145
U0-22	0x1016	4118	U0-50	0x1032	4146
U0-23	0x1017	4119	U0-51	0x1033	4147
U0-24	0x1018	4120	U0-52	0x1034	4148
U0-25	0x1019	4121	U0-53	0x1035	4149
U0-26	0x101A	4122	U0-57	0x1039	4153
U0-27	0x101B	4123	U0-58	0x103A	4154

Parameter	Modbus address		Parameter	Modbus address	
	Hex	Decimal		Hex	Decimal
U1-00	0x1100	4352	U2-00	0x1200	4608
U1-01	0x1101	4353	U2-01	0x1201	4609
U1-02	0x1102	4354	U2-02	0x1202	4610
U1-03	0x1103	4355	U2-03	0x1203	4611
U1-04	0x1104	4356	U2-04	0x1204	4612
U1-05	0x1105	4357	U2-05	0x1205	4613
U1-06	0x1106	4358	U2-06	0x1206	4614
U1-07	0x1107	4359	U2-07	0x1207	4615
U1-08	0x1108	4360	U2-08	0x1208	4616
U1-09	0x1109	4361	U2-09	0x1209	4617
U1-10	0x110A	4362	U2-10	0x120A	4618
U1-11	0x110B	4363	U2-11	0x120B	4619
U1-12	0x110C	4364	U2-12	0x120C	4620
U1-13	0x110D	4365	U2-13	0x120D	4621

U1-14	0x110E	4366	U2-14	0x120E	4622
U1-15	0x110F	4367	U2-15	0x120F	4623
U1-16	0x1110	4368	U2-16	0x1210	4624
U1-17	0x1111	4369	U2-17	0x1211	4625
U1-18	0x1112	4370	U2-20	0x1214	4628
U1-19	0x1113	4371	U4-11	0x140B	5131
U1-20	0x1114	4372	U4-12	0x140C	5132
U1-21	0x1115	4373	U4-13	0x140D	5133
U1-22	0x1116	4374	U4-14	0x140E	5134
U1-23	0x1117	4375	U4-15	0x140F	5135
U1-24	0x1118	4376			
U1-25	0x1119	4377			

Parameter	Modbus address		Parameter	Modbus address	
	Hex	Decimal		Hex	Decimal
F0-00	0x2000	8192	F1-00	0x2100	8448
F0-01	0x2001	8193	F1-01	0x2101	8449
F0-02	0x2002	8194	F1-02	0x2102	8450
F2-09	0x2209	8713	F1-03	0x2103	8451
			F1-04	0x2104	8452
			F1-05	0x2105	8453
			F1-06	0x2106	8454

Appendix 5. Q&A

Q1: What is BB and run on the panel?

1. BB standby state, without enabling, the motor is in the state of power failure.
2. Run running state, with enabling, the motor is in the power on state.

Q2: How to check and set the parameters?

Refer to chapter 4.6

Q3: How to change the parameters in enabled status?

P5-20=0000, enabling is invalid, P5-20=0010, enabling when power on, no need to power on again. The default value is 0001, which means input signal from SI1, SI1 connects to low voltage, +24V connects to high voltage (refer to chapter 3.2.2)

Q4: How to restore out of factory settings?

P5-20=0000 enabling is invalid, F0-01=1.

Q5: Which model supports bus mode?

DS5E series supports XNET communication (max 20-axis)

DS5C series supports EtherCAT communication (max 32-axis)

Q6: How to wiring for brake motor? How to modify parameters for slight slip of brake motor after power failure?

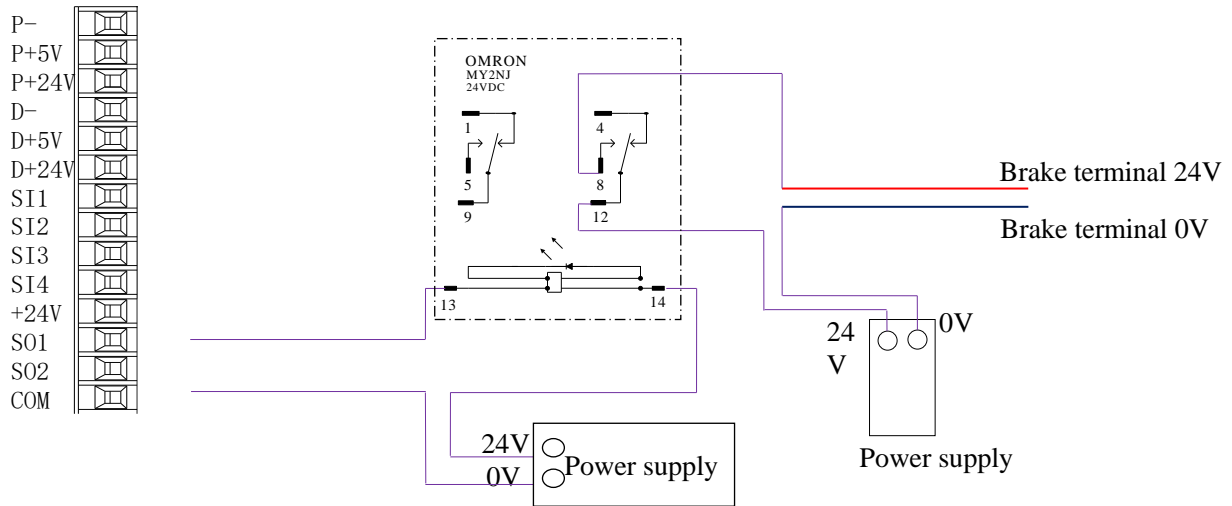

1. P5-44 defines the terminal of the brake output signal. As shown in the figure above, the S01 controls brake, that is, P5-44 = 0001.
2. Extend the delay time of servo OFF P5-07 (default 500ms), and the waiting time of braking instruction P5-09 is set to 0, which can be responded.

Q7: The initial direction is not what I want. How can I change it through a servo driver?

Change the initial direction by modifying P0-05, set the value to 0 or 1, and take effect after re-energizing. (For mode 2, 4, 6, 7 only). If the internal speed mode (mode 3) is used, the positive and negative values of the speed setting can be changed.

Q8: How do the two modes switch to each other?

Both P0-01 main mode and P0-02 sub-mode set the required mode. P5-30=0002 and SI2 are defined as mode switching terminals. When the SI2 terminal has no signal, it runs according to the set mode in the main mode P0-01. When the SI2 terminal has signal input, it runs according to the set mode in the sub-mode P0-02.

Note: SI2 terminal signal can be switched only if it is a constant ON signal.

Q9: What is the connection mode between PLC and servo?

1. NPN low-level output PLC: Y0 pulse connects P-, Y1 direction connects D-, +24V connects P+24, D+24. (Xinje PLC as an example)

PNP high-level output PLC: Q0.0 pulse connects P+24, Q0.2 direction connects D+24, 0V connects P-, D-. (Siemens PLC as an example) as follows:

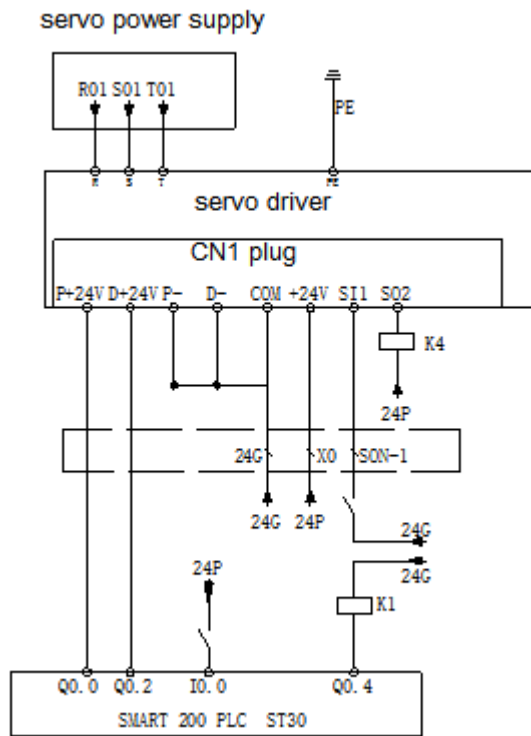

Q10: What is the external connection method and parameter setting of regenerative resistance?

There are P+, D, C terminals on the servo interface. There are short connectors between P+ and C (using built-in resistor). When the built-in resistor specifications are insufficient, the external resistor should be replaced. The specifications of the external regenerative resistor please refer to chapter 1.4.1.

(1) P+, D, C interface model: Remove the short joint between P+, D, and connect the external regenerative resistance to P+, C.

(2) P+, PB interface model: connect external regenerative resistance to P+, PB.

(3) Version number parameter U2-07 < 3700, set P0-24 = 1, P0-25 = power value, P0-26 = resistance value.

(4) Version number parameter U2-07 ≥ 3700, P0-24 need not be set, P0-25 = power value, P0-26 = resistance value.

Note: Before 3700 version, P0-24 should be set. Value 0 is for built-in resistance and value 1 is for external resistance.

Q11: The service life of tank chain?

The bending resistance is 5 million times and the bending radius is 50 mm.

Q12: How to connect bus control BD board and JA-NE-L?

A-A1, B-B1, SG-SG when one axis running; the PLC BD board and the terminal resistor of the last JA-NE-L board of electrical connection should be ON when multi-axis running; and the terminal resistance of JA-NE-L board in the middle should be OFF.

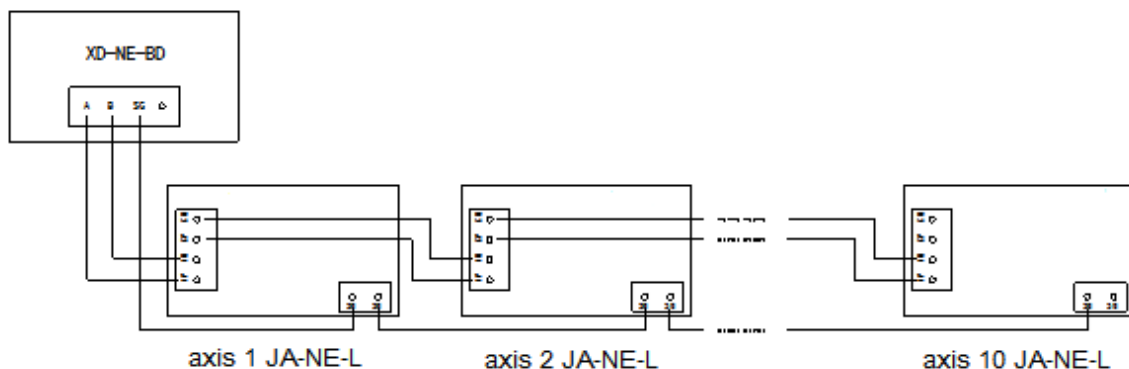

Appendix 6. General debugging steps

1. Motor empty shaft, preliminary debugging

A. Connect the cable correctly. Pay attention to the one-to-one connection of U, V, W and PE terminals, and the phase sequence can not be crossed.

B. Open-loop test run: The test run mainly checks the power cable and the encoder feedback cable to determine whether the connection is normal. According to the following operation, the motor can normally achieve positive and negative rotation. If the motor shaft shakes or prompts the alarm, it needs to cut off the power supply immediately, and re-check the wiring situation.

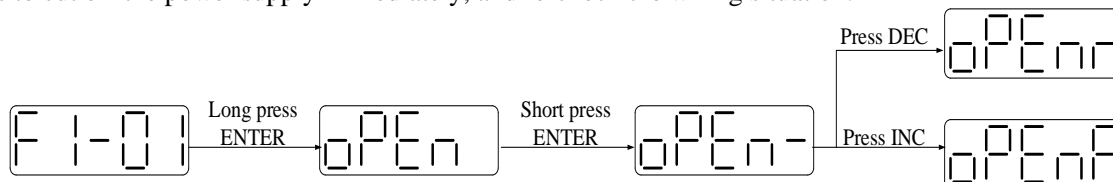

C. jog run: Enter F1-00.

Short press ENTER to enable the motor. In the enabled status, press INC for run forward, press DEC to run reverse. Press STATUS/ESC to exit.

Four status when jog running:

status	Panel display	status	Panel display
Idle		Forward run	
enabled		Reverse run	

2. Debug the motor with the machine

A. Observe the operating direction of the machine head. If it is contrary to the actual need, after the servo OFF, set the parameter P0-05 to 1, and then re-energize to make the change effective.

B. During the operation, observe the stability and responsiveness of the operation, and adjust the servo control parameters appropriately.

Appendix 7. Application example

Mode 6: Pulse instruction position mode

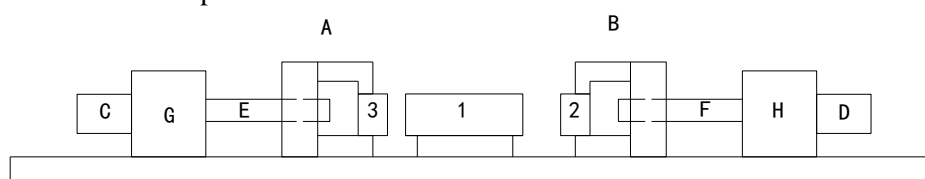

Equipment introduction:

This is a welder. Workpiece 1, 2, 3 are the object to be operated. 2 and 3 is fixed on B and A individually. A and B can whole move and be pushed by ball screw E and F. The screw pitch is 5mm. C and D is servo motor. G and H is reducer. The deceleration ratio is 40.

It needs to adjust the machine with standard dimension workpiece and find the origin of A and B.

Workpiece 1 lies on the worktable and moves left and right. Its dimension is positive tolerance, cannot shorter than standard workpiece. The process to put the workpiece is random. It requires that the left and right soldering is symmetrical.

A and B move toward 1 with 3 and 2 at the same speed. Whatever the position of 1, 2 or 3 will touch 1 at first and push 1 to another side until 2 and 3 all touch 1. The result is the motor torque will increase. At this time, 1 will at the symmetrical position.

A and B will return to the origin position after soldering is finished.

Analysis

1. Make sure the work mode: 6
2. It needs to judge whether 2 and 3 touch 1 when finding the symmetrical point first time. The sign is servo output torque will increase. It needs to use torque limit (P3-28, P3-29) and torque limit output signal /CLT.
3. As the dimension of workpiece 1 is larger than standard, offset pulse will remain in servo when the symmetrical point is found. /CLR signal can clear the pulse. The servo motor running distance is different from PLC pulse number. If it needs to know the actual distance, servo encoder feedback /A+, /A-, /B+, /B- and AB phase count are needed.
4. The machine motion direction of A and B.

Signal and terminal

/COIN positioning finished signal: SO1

/CLT torque up to upper limit output: SO2

/CLR pulse offset clear input: SI1

Encoder feedback signal /A+, /A-, /B+, /B-

Calculate the electronic gear ratio

Step	Explanation	Ball screw
		$1 \text{ rotation} = \frac{P}{\text{Command unit}}$
1	Confirm the mechanical specification	Ball screw pitch: 5mm Reduction ratio: 40/1
2	Confirm the encoder pulse number	131072
3	Decide the command unit	1 command unit: 0.001mm
4	Calculate the motion value of load shaft rotate 1 circle	5mm/0.001mm=5000
5	Calculate the electronic gear ratio	$\frac{B}{A} = \frac{2^{17}}{5000} = \frac{16384}{625}$
6	Set the user parameters	P0-13=16384 P0-14=625

Parameter setting

Running mode: P0-01=6

Pulse command state: P0-10=2

Electronic gear ratio: P0-11=0 P0-12=0 P0-13=16384 P0-14=625

Forward torque limit: P3-28=150

Reverse torque limit: P3-29=150

Positioning finished width: P5-00=7

/S-ON: P5-20=0010

/CLR: P5-34=0001

/COIN: P5-38=0001

/CLT: P5-42=0002

Appendix 8. Servo general mode parameters

Appendix 8.1 Basic parameters

Basic parameters	
Parameter	Overview
P0-03 enable mode P5-20 servo ON signal /S-ON	Enable mode selection, generally P0-03 is default, P5-20 sets n.0010 as enable on after power on
P0-04 Rigidity grade	Adjust servo gain in auto-tuning fast adjustment mode
P0-05 Definition of rotation direction	Determine the motor direction, generally 0/1 by default
P0-25 Power value of discharge resistance P0-26 Discharge resistance value	Set the specification parameters of external regeneration resistance to ensure that they are the same as the actual ones
P3-28 internal forward torque limit P3-29 internal reverse torque limit P3-30 external forward torque limit P3-31 external reverse torque limit	Set servo torque limit source and limit value. The unit of default value is the percentage of servo torque
P5-44 power loss brake / BK P5-07 servo off delay time P5-08 brake command output speed P5-09 brake command waiting time	The motor with holding brake adopts servo SO terminal to control the setting parameters of holding brake
P5-47 alarm output /ALM	output alarm function setting through the SO terminal, SO2 terminal default output is dynamic closing signal.
P7-00 RS485 Station No P7-01 communication configuration P7-02 RS485 communication protocol	Communication setting related parameters

Appendix 8.2 External pulse position mode general parameters

External pulse position mode general parameters	
Parameter	Overview
P0-01 control mode selection	Set to 6: external pulse mode
P0-10 pulse instruction format	Set pulse format 0-CW/CCW 1-AB 2-P+D
P0-11 set motor pulses per revolution * 1 P0-12 set motor pulses per revolution * 10000 P0-13 electronic gear ratio (numerator) P0-14 electronic gear ratio (denominator) P0-92~P0-93 32-bit electronic gear ratio numerator	Setting of command pulse number required for one revolution of motor When P0-11 / P0-12 are all zero, P0-13 / P0-14 takes effect When P0-11-P0-14 is zero, P0-92~P0-95 is effective 32-bit gear ratio numerator: $P0-92 * 1 + P0-93 * 10000$ 32-bit gear ratio denominator: $P0-94 * 1 + P0-95 * 10000$

P0-94~P0-95 32-bit electronic gear ratio denominator	
P0-09 pulse instruction setting	Each bit can set the command direction and filter time of low-speed pulse respectively

Appendix 8.3 Internal position mode general parameters

Internal position mode general parameters	
Parameter	Overview
P0-01 control mode selection	Set to 5: internal position mode
P4-03 internal position setting mode P4-04 number of effective segments P4-10 ~ P4-254 internal section 1 to section 35 position parameter setting	Control mode setting of internal position mode: including step change mode, positioning mode and adjustment time Configuration of pulse displacement, speed, acceleration and deceleration time of each section
P5-35 step change signal /GHGSTP P5-32 suspend the current signal /Inhibit P5-31 skip current segment No. /Z-Clamp	Common terminal function assignment
P4-00 Number of Z-phase signals after leaving limit switch P4-01 speed of collision with proximity switch P4-02 speed of leaving proximity switch P5-28 find reference origin in forward side under position mode /SPD-A P5-29 find reference origin in forward side under position mode /SPD-B	Internal position back to origin setting parameters
F2-09 35 Any setting of segment position	Set the segment no. through communication

Appendix 8.4 Internal torque control general parameters

Internal torque control	
Parameter	Overview
P0-01 control mode selection	Set to 1: internal torque mode
P3-33 Internal torque command given	The given value is the percentage of rated torque
P3-16 internal forward speed limit for torque control P3-17 internal reverse speed limit for torque control P3-14 forward maximum speed limit (max speed) P3-15 reverse maximum speed limit (max speed)	Speed limit in torque mode
P5-27 speed direction switch /SPD-D	Change direction, default is n.0000. If the direction changing is given through SI2 terminal, p5-27 can be set to n.0002.

Appendix 8.5 External analog torque control general parameters

External analog torque control	
Parameter	Overview
P0-01 control mode selection	Set to 2: external pulse mode
P3-24 analog voltage corresponding to rated torque	Set the speed command voltage required to run the servo motor at rated speed, unit: 0.001V
P3-25 analog voltage torque command filter	Unit 0.01ms
P3-26 torque command input dead zone voltage	Unit 0.001V

Appendix 8.6 Internal speed control general parameters

Internal speed control	
Parameter	Overview
P0-01 control mode selection	Set to 3: internal speed control mode
P3-05 internal set speed 1 P3-06 internal set speed 2 P3-07 internal set speed 3	Speed value setting of internal 3-segment speed in rpm
P5-28 internal speed selection /SPD-A P5-29 internal speed selection /SPD-B	The combination of terminals determines the speed of corresponding section
P5-27 internal speed direction selection /SPD-D	Change direction, default is n.0000. If the direction changing is given through SI2 terminal, p5-27 can be set to n.0002.
P3-09 soft start acceleration time P3-10 soft start deceleration time	Set acceleration and deceleration time in ms

Appendix 8.7 External pulse speed control general parameters

External pulse speed control	
Parameter	Overview
P0-01 control mode selection	Set to 7: external pulse speed mode
P0-10 pulse command format	Set the pulse format 0-CW/CCW 1-AB 2-P+D
P0-15 Command pulse frequency at rated speed	Determine the linear relationship between the command pulse frequency and the speed
P0-16 Speed command pulse filtering time	When the command pulse frequency is relatively low, setting this parameter properly can reduce the speed fluctuation

Appendix 8.8 External analog speed control general parameters

External analog speed control	
Parameter	Overview
P0-01 control mode selection	Set to 4: external pulse mode
P3-00 Voltage of analog quantity corresponding to rated speed	Set the speed command voltage required to run the servo motor at rated speed, unit: 0.001V
P3-09 soft start acceleration time P3-10 soft start deceleration time	Set acceleration and deceleration time in ms
P3-02 analog voltage speed filter	Unit 0.01ms
P3-03 Speed command input deadband voltage	Unit 0.001V
P3-04 Analog speed direction switch	Switch the input direction of analog speed command

Appendix 9. Torque-speed characteristic curve

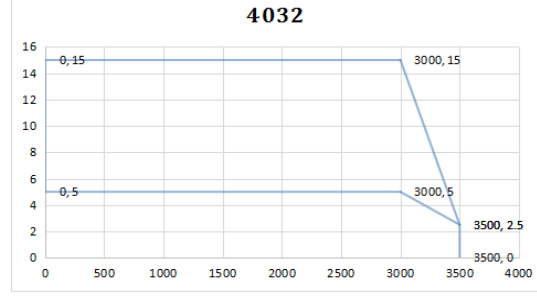
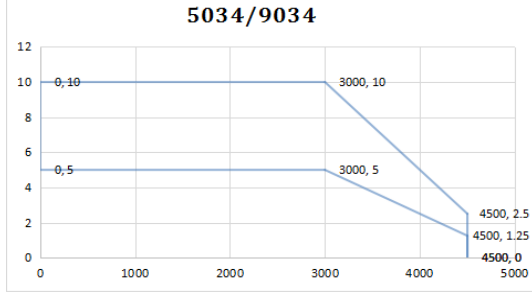
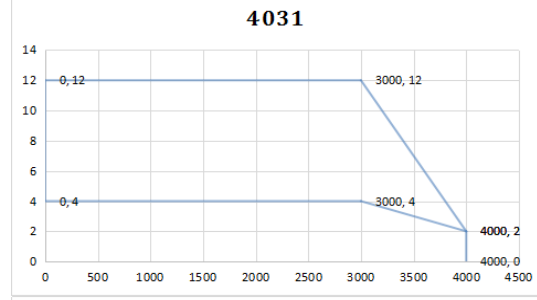
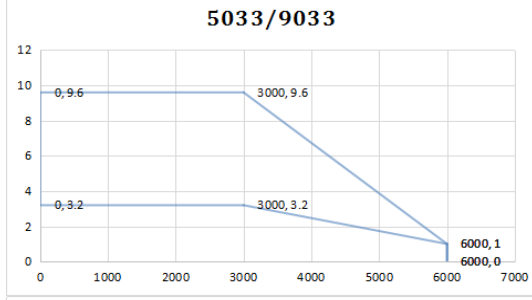
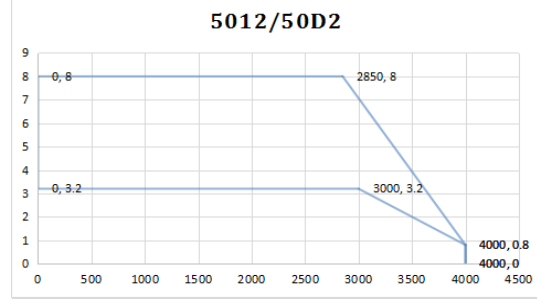
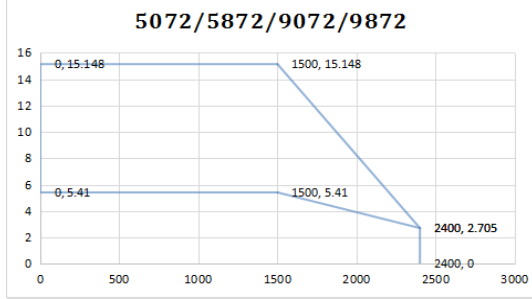
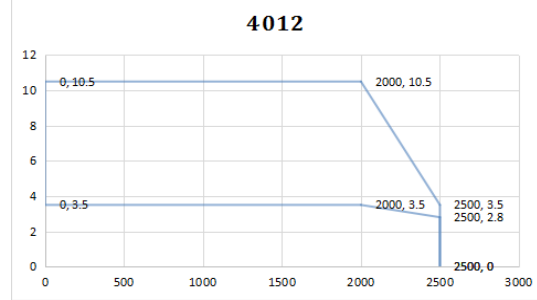
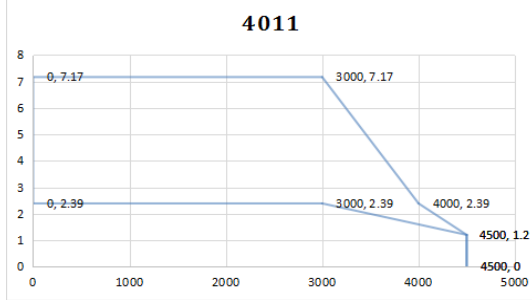
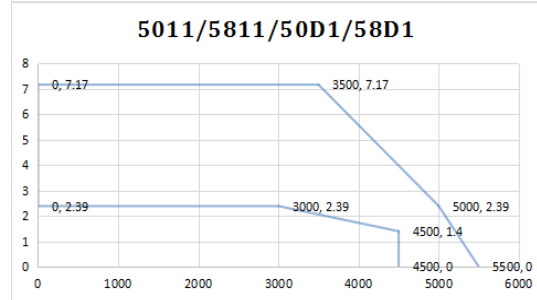
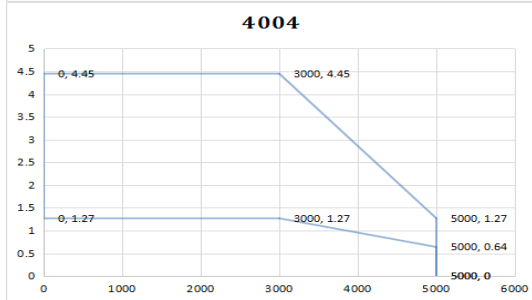
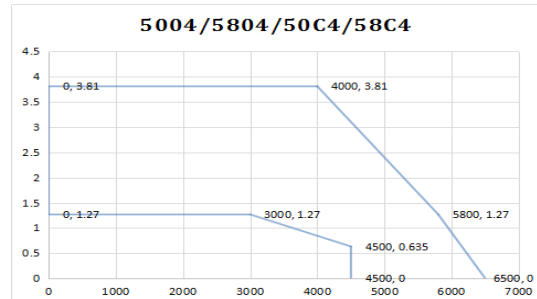
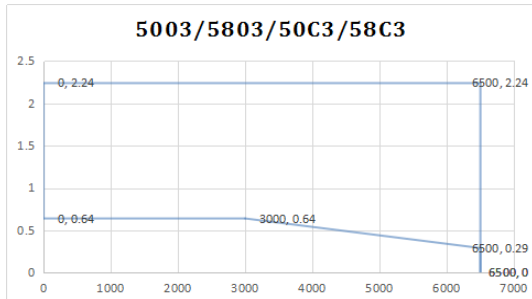

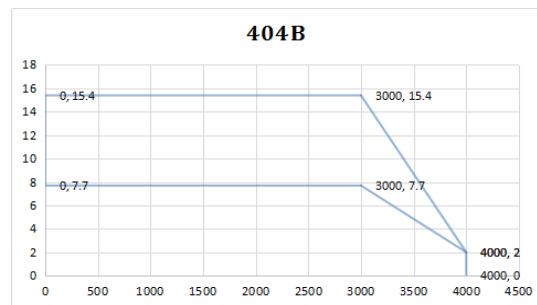
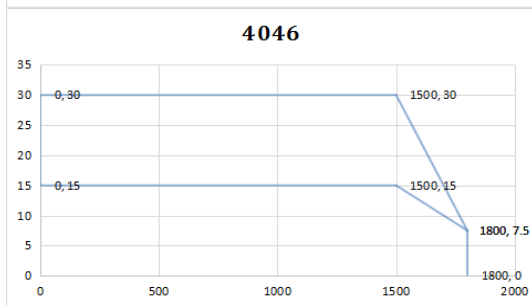
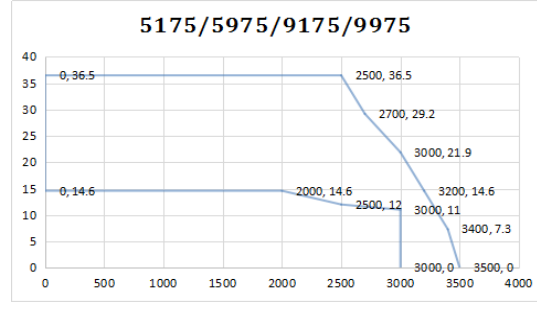
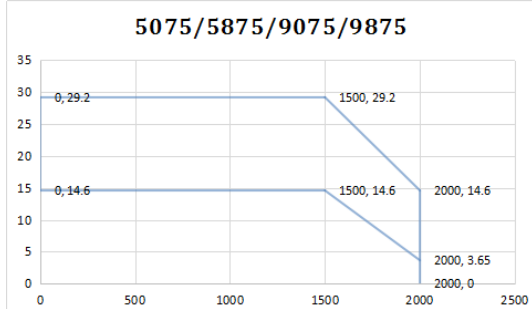
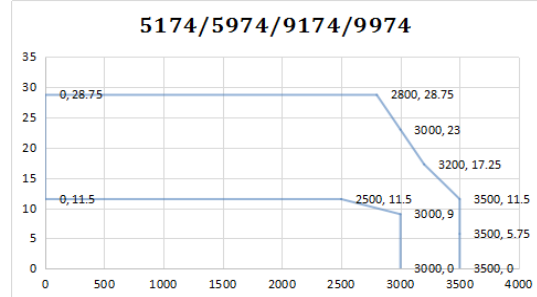
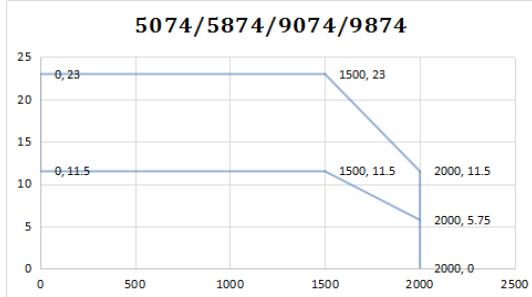
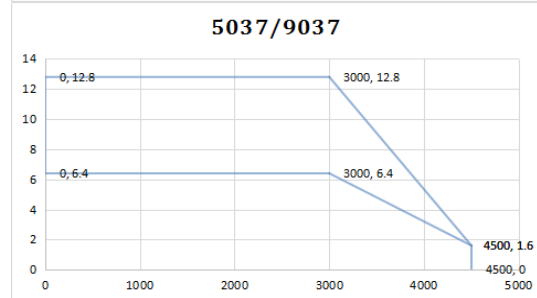
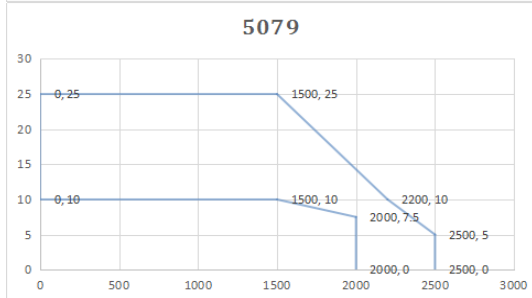
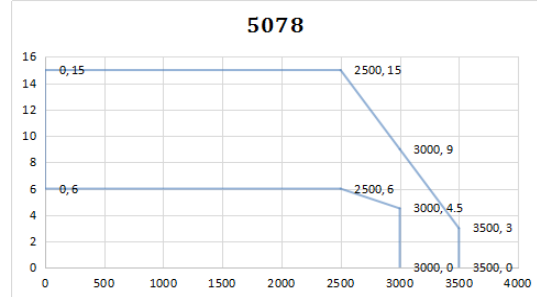
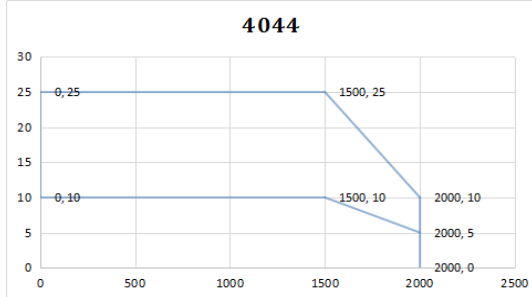
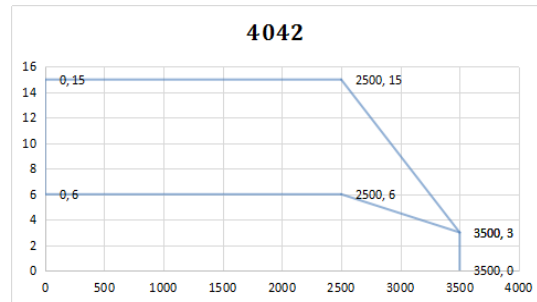
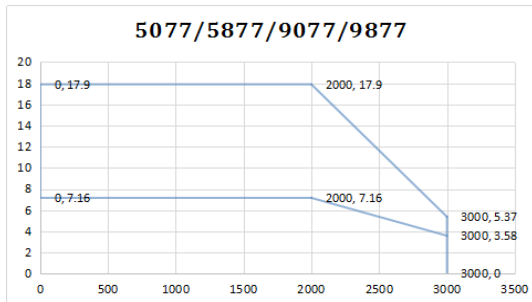

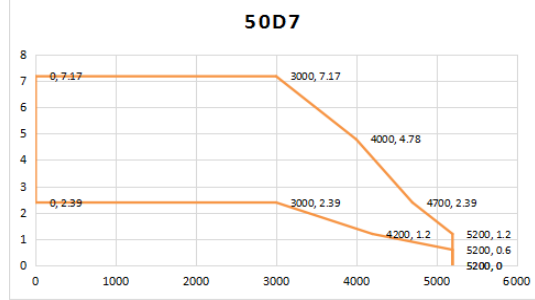
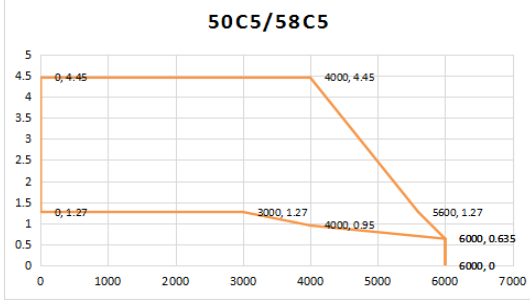
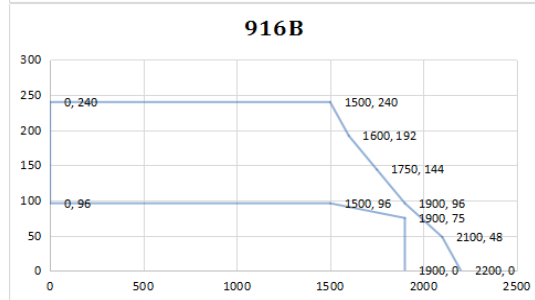
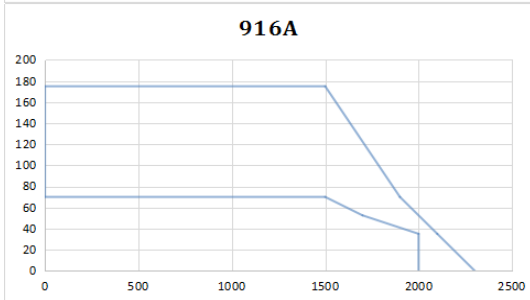
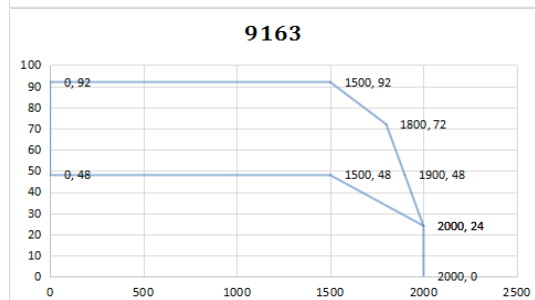
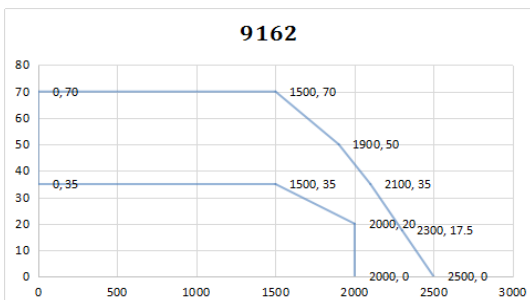
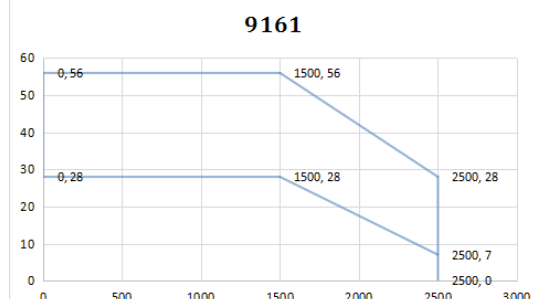
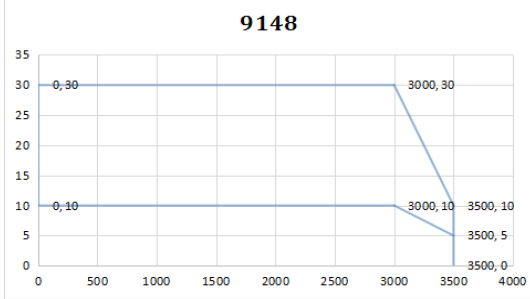
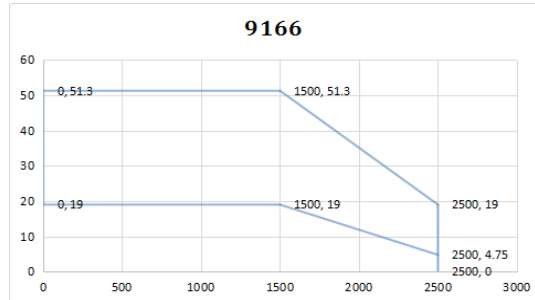
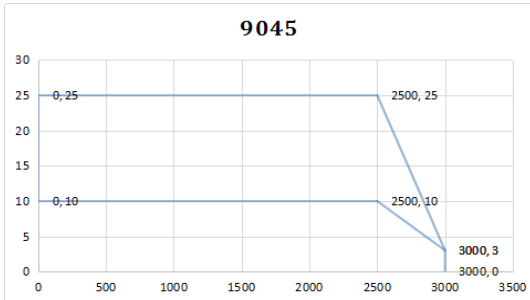

Appendix 10. List of model selection and configuration

Motor model	Matched driver	Encoder cable	Power cable	Brake cable	Cable accessories package
MS5S-40ST□-CS00330B-20P1-S01	DS5E/L/C/F/K-20 P1-PTA	CP(T)-SP-M-length	CM(T)-P07-M-length		JAM-P9-P4
MS5S-40ST□-CM00330B-20P1-S01		CP(T)-SP-B M-length	CM(T)-P07-M-length		JAM-P9-P4
MS5S-40ST□-CS00330BZ-20P1-S01		CP(T)-SP-M-length	CM(T)-P07-M-length	CB(T)-P03-length	JAM-P9-P4-P2
MS5S-40ST□-CM00330BZ-20P1-S01		CP(T)-SP-B M-length	CM(T)-P07-M-length	CB(T)-P03-length	JAM-P9-P4-P2
MS5S-60ST□-CS00630B-20P2-S01	DS5E/L/C/F/K-20 P2-PTA	CP(T)-SP-M-length	CM(T)-P07-M-length		JAM-P9-P4
MS5S-60ST□-CM00630B-20P2-S01		CP(T)-SP-B M-length	CM(T)-P07-M-length		JAM-P9-P4
MS5S-60ST□-CS00630BZ-20P2-S01		CP(T)-SP-M-length	CM(T)-P07-M-length	CB(T)-P03-length	JAM-P9-P4-P2
MS5S-60ST□-CM00630BZ-20P2-S01		CP(T)-SP-B M-length	CM(T)-P07-M-length	CB(T)-P03-length	JAM-P9-P4-P2
MS5H-60ST□-CS00630B-20P2-S01		CP(T)-SP-M-length	CM(T)-P07-M-length		JAM-P9-P4
MS5H-60ST□-CM00630B-20P2-S01		CP(T)-SP-B M-length	CM(T)-P07-M-length		JAM-P9-P4
MS5H-60ST□-CS00630BZ-20P2-S01		CP(T)-SP-M-length	CM(T)-P07-M-length	CB(T)-P03-length	JAM-P9-P4-P2
MS5H-60ST□-CM00630BZ-20P2-S01		CP(T)-SP-B M-length	CM(T)-P07-M-length	CB(T)-P03-length	JAM-P9-P4-P2
MS5S-60ST□-CS01330B-20P4-S01	DS5E/L/C/F/K-20 P4-PTA	CP(T)-SP-M-length	CM(T)-P07-M-length		JAM-P9-P4
MS5S-60ST□-CM01330B-20P4-S01		CP(T)-SP-B M-length	CM(T)-P07-M-length		JAM-P9-P4
MS5S-60ST□-CS01330BZ-20P4-S01		CP(T)-SP-M-length	CM(T)-P07-M-length	CB(T)-P03-length	JAM-P9-P4-P2
MS5S-60ST□-CM01330BZ-20P4-S01		CP(T)-SP-B M-length	CM(T)-P07-M-length	CB(T)-P03-length	JAM-P9-P4-P2
MS5H-60ST□-CS01330B-20P4-S01		CP(T)-SP-M-length	CM(T)-P07-M-length		JAM-P9-P4
MS5H-60ST□-CM01330B-20P4-S01		CP(T)-SP-B M-length	CM(T)-P07-M-length		JAM-P9-P4
MS5H-60ST□-CS01330BZ-20P4-S01		CP(T)-SP-M-length	CM(T)-P07-M-length	CB(T)-P03-length	JAM-P9-P4-P2
MS5H-60ST□-CM01330BZ-20P4-S01		CP(T)-SP-B M-length	CM(T)-P07-M-length	CB(T)-P03-length	JAM-P9-P4-P2
MS-60ST□-T01330B□-20P4-D01		CP(T)-SP-B-length	CM(T)-P07-length		JAM-P9-P4
MS6S-60CS30B1-20P4		CP(T)-SP-M-length	CM(T)-P07-M-length		JAM-P9-P4
MS6S-60CM30B1-20P4		CP(T)-SP-B M-length	CM(T)-P07-M-length		JAM-P9-P4
MS6S-60CS30BZ1-20P4		CP(T)-SP-M-length	CM(T)-P07-M-length	CB(T)-P03-length	JAM-P9-P4-P2
MS6S-60CM30BZ1-20P4		CP(T)-SP-B M-length	CM(T)-P07-M-length	CB(T)-P03-length	JAM-P9-P4-P2
MS6H-60CS30B1-20P4		CP(T)-SP-	CM(T)-P07-		JAM-P9-P4

Motor model	Matched driver	Encoder cable	Power cable	Brake cable	Cable accessories package
		M-length	M-length		
MS6H-60CM30B1-20P4		CP(T)-SP-B M-length	CM(T)-P07- M-length		JAM-P9-P4
MS6H-60CS30BZ1-20P4		CP(T)-SP- M-length	CM(T)-P07- M-length	CB(T)-P 03-length	JAM-P9-P4-P 2
MS6H-60CM30BZ1-20P4		CP(T)-SP-B M-length	CM(T)-P07- M-length	CB(T)-P 03-length	JAM-P9-P4-P 2
MS5S-80ST□-CS02430B-20P7-S 01	DS5E/L/C/F/K-20 P7-PTA	CP(T)-SP- M-length	CM(T)-P07- M-length		JAM-P9-P4
MS5S-80ST□-CM02430B-20P7-S 01		CP(T)-SP-B M-length	CM(T)-P07- M-length		JAM-P9-P4
MS5S-80ST□-CS02430BZ-20P7- S01		CP(T)-SP- M-length	CM(T)-P07- M-length	CB(T)-P 03-length	JAM-P9-P4-P 2
MS5S-80ST□-CM02430BZ-20P7- S01		CP(T)-SP-B M-length	CM(T)-P07- M-length	CB(T)-P 03-length	JAM-P9-P4-P 2
MS5H-80ST□-CS02430B-20P7-S 01		CP(T)-SP- M-length	CM(T)-P07- M-length		JAM-P9-P4
MS5H-80ST□-CM02430B-20P7- S01		CP(T)-SP-B M-length	CM(T)-P07- M-length		JAM-P9-P4
MS5H-80ST□-CS02430BZ-20P7- S01		CP(T)-SP- M-length	CM(T)-P07- M-length	CB(T)-P 03-length	JAM-P9-P4-P 2
MS5H-80ST□-CM02430BZ-20P7- -S01		CP(T)-SP-B M-length	CM(T)-P07- M-length	CB(T)-P 03-length	JAM-P9-P4-P 2
MS-80ST□-T02430B□-20P7		CP(T)-SP-B -length	CM(T)-P07- length		JAM-P9-P4
MS-80ST□-T03520B□-20P7		CP(T)-SP-B -length	CM(T)-P07- length		JAM-P9-P4
MS5G-130STE-CS05415B-20P8- S01		CP(T)-SC- M-length	CM(T)-L15 A-length		JAM-C10-L7
MS5G-130STE-CM05415B-20P8- S01		CP(T)-SC- B-length	CM(T)-L15 A-length		JAM-C10-L7
MS5G-130STE-CS05415BZ-20P8 -S01		CP(T)-SC- M-length	CMB(T)-L1 5A-length		JAM-C10-L7
MS5G-130STE-CM05415BZ-20P 8-S01		CP(T)-SC- B-length	CMB(T)-L1 5A-length		JAM-C10-L7
MS5G-130STE-TL05415B-20P8- S01		CP(T)-SC- B-length	CM(T)-L15 A-length		JAM-C10-L7
MS5G-130STE-TL05415BZ-20P8 -S01		CP(T)-SC- B-length	CMB(T)-L1 5A-length		JAM-C10-L7
MS5S-80ST□-CS03230B□-21P0- S01		CP(T)-SP- M-length	CM(T)-P07- M-length	Please choose CB(T)-P 03-length when with brake	Without brake: JAM-P9-P4 with brake: JAM-P9-P4-P 2
MS5S-80ST□-CM03230B□-21P0- S01		CP(T)-SP-B M-length	CM(T)-P07- M-length		
MS5H-80ST□-CS03230B□-21P0- S01		CP(T)-SP- M-length	CM(T)-P07- M-length		
MS5H-80ST□-CM03230B□-21P0 -S01		CP(T)-SP-B M-length	CM(T)-P07- M-length		
MS6S-80CS30B1-20P7		CP(T)-SP- M-length	CM(T)-P07- M-length		JAM-P9-P4
MS6S-80CM30B1-20P7		CP(T)-SP-B M-length	CM(T)-P07- M-length		JAM-P9-P4
MS6S-80CS30BZ1-20P7		CP(T)-SP- M-length	CM(T)-P07- M-length	CB(T)-P 03-length	JAM-P9-P4-P 2

Motor model	Matched driver	Encoder cable	Power cable	Brake cable	Cable accessories package
MS6S-80CM30BZ1-20P7		CP(T)-SP-B M-length	CM(T)-P07- M-length	CB(T)-P 03-length	JAM-P9-P4-P 2
MS6H-80CS30B1-20P7		CP(T)-SP- M-length	CM(T)-P07- M-length		JAM-P9-P4
MS6H-80CM30B1-20P7		CP(T)-SP-B M-length	CM(T)-P07- M-length		JAM-P9-P4
MS6H-80CS30BZ1-20P7		CP(T)-SP- M-length	CM(T)-P07- M-length	CB(T)-P 03-length	JAM-P9-P4-P 2
MS6H-80CM30BZ1-20P7		CP(T)-SP-B M-length	CM(T)-P07- M-length	CB(T)-P 03-length	JAM-P9-P4-P 2
MS5S-110STE-CS03230B□-21P0-S01	DS5E/L/C/F/K-21 P5-PTA	CP(T)-SL- M-length	CM(T)-L15- length		JAM-L15-L4
MS5S-110STE-CM03230B□-21P0-S01		CP(T)-SL- B-length	CM(T)-L15- length		JAM-L15-L4
MS5S-110STE-TL03230B□-21P0		CP(T)-SL- B-length	CM(T)-L15- length		JAM-L15-L4
MS-110ST□-T04030B□-21P2		CP(T)-SL- B-length	CM(T)-L15- length		JAM-L15-L4
MS-110ST□-T05030B□-21P5		CP(T)-SL- B-length	CM(T)-L15- length		JAM-L15-L4
MS5S-110STE-CS04830B□-21P5		CP(T)-SL- M-length	CM(T)-L15- length		JAM-L15-L4
MS5S-110STE-CM04830B□-21P5		CP(T)-SL- B-length	CM(T)-L15- length		JAM-L15-L4
MS5S-110STE-TL04830B□-21P5		CP(T)-SL- B-length	CM(T)-L15- length		JAM-L15-L4
MS-130ST-T06025B□-21P5		CP(T)-SL- B-length	CM(T)-L15- length		JAM-L15-L4
MS-130ST-T10015B□-21P5		CP(T)-SL- B-length	CM(T)-L15- length		JAM-L15-L4
MS5G-130STE-CS07220B-21P5-S01		CP(T)-SC- M-length	CM(T)-L15- length		JAM-C10-L4
MS5G-130STE-CM07220B-21P5-S01		CP(T)-SC- B-length	CM(T)-L15- length		JAM-C10-L4
MS5G-130STE-CS07220BZ-21P5-S01		CP(T)-SC- M-length	CMB(T)-L1 5-length		JAM-C10-L7
MS5G-130STE-CM07220BZ-21P5-S01		CP(T)-SC- B-length	CMB(T)-L1 5-length		JAM-C10-L7
MS5G-130STE-TL07220B-21P5-S01		CP(T)-SC- B-length	CM(T)-L15- length		JAM-C10-L4
MS5G-130STE-TL07220BZ-21P5-S01		CP(T)-SC- B-length	CMB(T)-L1 5-length		JAM-C10-L7
MS5G-130STE-CS11515B-21P8-S01		CP(T)-SC- M-length	CM(T)-L15- length		JAM-C10-L4
MS5G-130STE-CM11515B-21P8-S01		CP(T)-SC- B-length	CM(T)-L15- length		JAM-C10-L4
MS5G-130STE-CS11515BZ-21P8-S01		CP(T)-SC- M-length	CMB(T)-L1 5-length		JAM-C10-L7
MS5G-130STE-CM11515BZ-21P8-S01		CP(T)-SC- B-length	CMB(T)-L1 5-length		JAM-C10-L7
MS5G-130STE-TL11515B-21P8-S01	CP(T)-SC- B-length	CM(T)-L15- length		JAM-C10-L4	
MS5G-130STE-TL11515BZ-21P8	CP(T)-SC- B-length	CMB(T)-L1 5-length		JAM-C10-L7	

Motor model	Matched driver	Encoder cable	Power cable	Brake cable	Cable accessories package
-S01		B-length	5-length		
MS5S-110STE-TL06030B□-21P8		CP(T)-SL-B-length	CM(T)-L15-length		JAM-L15-L4
MS5S-110STE-CS06030B□-21P8		CP(T)-SL-M-length	CM(T)-L15-length		JAM-L15-L4
MS5S-110STE-CM06030B□-21P8		CP(T)-SL-B-length	CM(T)-L15-length		JAM-L15-L4
MS5G-130STE-CS14615B-22P3-S01		CP(T)-SC-M-length	CM(T)-L15-length		JAM-C10-L4
MS5G-130STE-CM14615B-22P3-S01		CP(T)-SC-B-length	CM(T)-L15-length		JAM-C10-L4
MS5G-130STE-CS14615BZ-22P3-S01		CP(T)-SC-M-length	CMB(T)-L15-length		JAM-C10-L7
MS5G-130STE-CM14615BZ-22P3-S01		CP(T)-SC-B-length	CMB(T)-L15-length		JAM-C10-L7
MS5G-130STE-TL14615B-22P3-S01		CP(T)-SC-B-length	CM(T)-L15-length		JAM-C10-L4
MS5G-130STE-TL14615BZ-22P3-S01		CP(T)-SC-B-length	CMB(T)-L15-length		JAM-C10-L7
MS-130ST-T15015GB□-22P3		CP(T)-SL-B-length	CM(T)-L15-length		JAM-L15-L4
MS-130ST-TL15015GB-22P3		CP(T)-SL-B-length	CM(T)-L15-length		JAM-L15-L4
MS-130STE-TL15015GB-22P3-F		CP(T)-SL-B-length	CM(T)-L15-length		JAM-L15-L4
MS-130STE-T07730B□-22P4		CP(T)-SL-B-length	CM(T)-L15-length		JAM-L15-L4
MS-130STE-T07730B□-22P4	DS5E/L/C/F/K-22P6-PTA	CP(T)-SL-B-length	CM(T)-L15-length		JAM-L15-L4
MS-130ST-TL10025B□-22P6		CP(T)-SL-B-length	CM(T)-L15-length		JAM-L15-L4
MS5G-130STE-CS11515B-41P8-S01		CP(T)-SC-M-length	CM(T)-L15-length		JAM-C10-L4
MS5G-130STE-CM11515B-41P8-S01		CP(T)-SC-B-length	CM(T)-L15-length		JAM-C10-L4
MS5G-130STE-CS1515BZ-41P8-S01		CP(T)-SC-M-length	CMB(T)-L15-length		JAM-C10-L7
MS5G-130STE-CM11515BZ-41P8-S01	DS5E-41P5-PTA	CP(T)-SC-B-length	CMB(T)-L15-length		JAM-C10-L7
MS5G-130STE-TL11515B-41P8-S01		CP(T)-SC-B-length	CM(T)-L15-length		JAM-C10-L4
MS5G-130STE-TL11515BZ-41P8-S01		CP(T)-SC-B-length	CMB(T)-L15-length		JAM-C10-L7
MS5G-130ST-CS14615B-42P3-S01		CP(T)-SC-M-length	CM(T)-L15-length		JAM-C10-L4
MS5G-130ST-CM14615B-42P3-S01		CP(T)-SC-B-length	CM(T)-L15-length		JAM-C10-L4
MS5G-130ST-CS14615BZ-42P3-S01	DS5E/C/F/K-43P0-PTA	CP(T)-SC-M-length	CMB(T)-L15-length		JAM-C10-L7
MS5G-130ST-CM14615BZ-42P3-S01		CP(T)-SC-B-length	CMB(T)-L15-length		JAM-C10-L7
MS5G-130ST-TL14615B-42P3-S01		CP(T)-SC-B-length	CM(T)-L15-length		JAM-C10-L4

Motor model	Matched driver	Encoder cable	Power cable	Brake cable	Cable accessories package
MS5G-130ST-TL14615BZ-42P3-S01		CP(T)-SC-B-length	CMB(T)-L15-length		JAM-C10-L7
MS5G-180STE-TL19015B□-42P9		CP(T)-SL-B-length	CM(T)-XL25-length		JAM-L15-XL4
MS-130ST-TL10030B(Z)-43P0		CP(T)-SL-B-length	CM(T)-L15-length		JAM-L15-L4
MS5G-180STE-TL28015B□-44P4	DS5E/C/F-45P5-PTA	CP(T)-SL-B-length	CM(T)-XL60-length		JAM-L15-XL4
MS5G-180STE-TL35015B□-45P5		CP(T)-SL-B-length	CM(T)-XL60-length		JAM-L15-XL4
MS5G-180STE-TL48015B□-47P5	DS5E/C/F-47P5-PTA	CP(T)-SL-B-length	CM(T)-XL60-length		JAM-L15-XL4
MS-220STE-TL70015B□-411P0-XJ	DS5E-411P0-PTA	CPT-ZDL-B-length	CM(T)-D60-length		-
MS-220STE-TL96015B□-415P0-XJ	DS5E-415P0-PTA	CPT-ZDL-B-length	CM(T)-D60-length		-

XINJE



We chat ID

WUXI XINJE ELECTRIC CO., LTD.

4th Floor Building 7,Originality Industry
park, Liyuan Development Zone, Wuxi
City, Jiangsu Province

214072

Tel: (510) 85134136

Fax: (510) 85111290